

ORIGINALLY

Catalogue  
2021

ITA/ENG



alba components

# ORIGINALLY

Collection  
2021

— new product



8

90



46

aba



180

athos



201

bench components

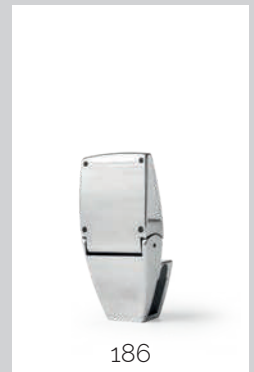

186

components



152

eden

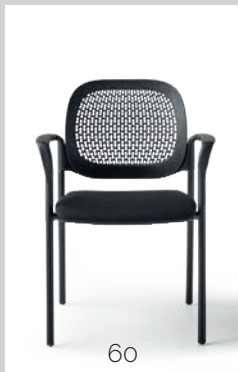

60

equity



174

flash



114

oki

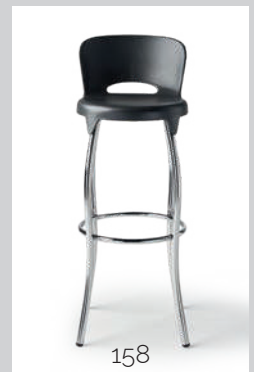

158

paco



30  
pinko



144  
perù



94  
pull



102  
q5

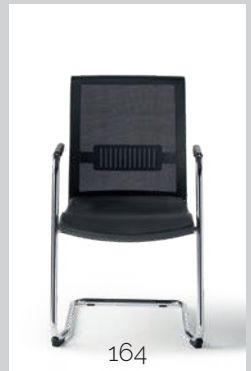

164  
q9



124  
race



136  
smile



22  
vicenza



74  
x3



out of catalogue



out of catalogue

butterfly

victor

disponibili con telai 4 gambe e panca  
available with 4-legs and bench frame

# ORIGINALLY

## Catalogue 2021

I nuovi strumenti di vendita **AlbaComponents** sono stati sviluppati in coerenza al **concept di comunicazione Evolution**, per raccontare i valori dell'azienda e i pillars su cui fonda il suo operato, al fine di proporre un'offerta unica e distintiva.

Per il **2021** la scelta è stata di proporre **due cataloghi: Originally e Advanced**. Le proposte **AlbaComponents** più storiche sono state divise da quelle più recenti, al fine di favorire un più semplice utilizzo degli strumenti da parte dei nostri clienti.

**Il bruco e la farfalla** del concept **Evolution** raccontano **l'importante evoluzione che l'azienda**, trasformando con sapienza la materia prima, **è riuscita a compiere** per garantire un'offerta sempre distintiva, unica, evoluta.

*The new **AlbaComponents** sales instruments have been developed to be coherent with the **Evolution communication concept**, to convey the company's values and the pillars upon which its approach to operations are based, with the aim of ensuring what we offer is both unique and distinctive.*

*For **2021** we've decided to publish **two catalogues: Originally and Advanced**. We've divided the more historic range of **AlbaComponents** for our more recent products, to make it easier for our clients to use these instruments.*

***The caterpillar and the butterfly** of the **Evolution** concept symbolise **the major evolution the company has managed to complete** by expertly transforming raw materials into an offer which is always guaranteed to be distinctive, unique and evolved.*



La **mano** del concept **Evolution** rappresenta il **lavoro, il talento e la passione** di tutte le persone che contribuiscono ogni giorno al successo del marchio.

the **Evolution** concept

## #History

Il **bruco** racconta la **Storicità e il Know How** di AlbaComponents che permangono nel tempo a garanzia di qualità e sicurezza.

The **caterpillar** represents **AlbaComponents' heritage and know-how** which have remained constant over time, guaranteeing quality and safety.

The **hand** of the **Evolution** concept symbolises **the work, talent and enthusiasm** of all the people that contribute every day to the success of the brand.

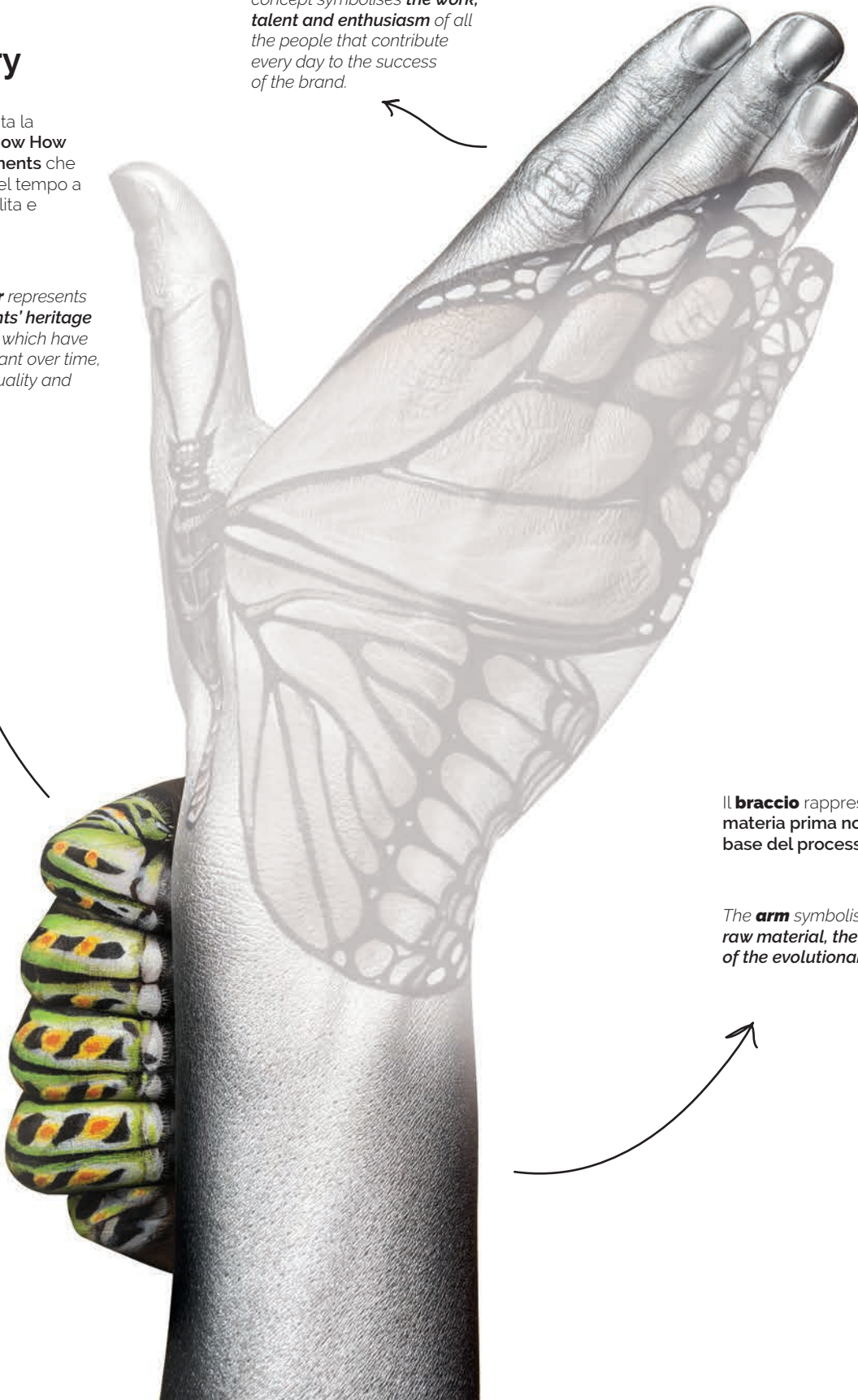

Il **braccio** rappresenta una **materia prima nobile, alla base del processo evolutivo.**

The **arm** symbolises the **noble raw material, the very essence of the evolutionary process.**

Nel **catalogo Originally** sono riuniti tutti i prodotti che rappresentano i valori su cui **AlbaComponents** ha fondato sin dalla nascita il proprio operato e che hanno garantito la crescita del marchio fino ad arrivare ad offrire un'offerta *Evoluta*, riunita nel catalogo **Advanced**.

In particolare i pillars presenti nell'offerta più storica dell'azienda e che permangono anche nelle proposte più recenti sono:

**#History**

**#Solutions**

**#Logistic**

---

*The **Originally catalogue** contains all the products that represent the values upon which, **AlbaComponents'** approach to business have been founded right from the beginning. These have guaranteed the growth of the brand, and have ultimately paved the way for our more Evolved product selection, which we've grouped together in the **Advanced catalogue**.*

*In particular, the pillars at the heart of the company's historic product range, which we've maintained in our latest product selection are:*

**#History**

**#Solutions**

**#Logistic**



---

#History



---

#Solutions



---

#Logistic



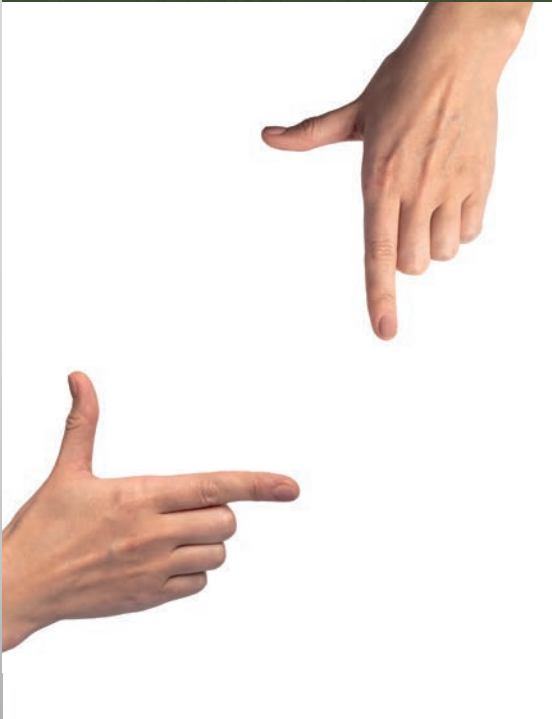
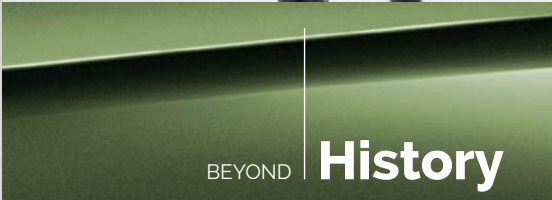



90



# 90



---

side

4 legs

4 legs w/armrests

4 legs w/writing tablet

swivel

bench



EN 1728

tools



certification

90 showing



La **serie 90** è caratterizzata da un **design classico** e dalla riconosciuta **qualità AlbaComponents**.

Un **ampio assortimento di telai e componenti** completano l'offerta di un prodotto essenziale e versatile, capace di soddisfare ogni esigenza negli ambiti più diversi, rendendola una sedia dai grandi numeri.  
**Certificata CATAS.**

***Serie 90** is characterized by a **classic design** and **famed AlbaComponents quality**.*

*A **wide assortment of frames and components** complete the options available for this essential and versatile product. It caters for a broad range of needs in the most diverse settings, making it a very popular chair.  
**CATAS certified.***



# 90

## 4-legs

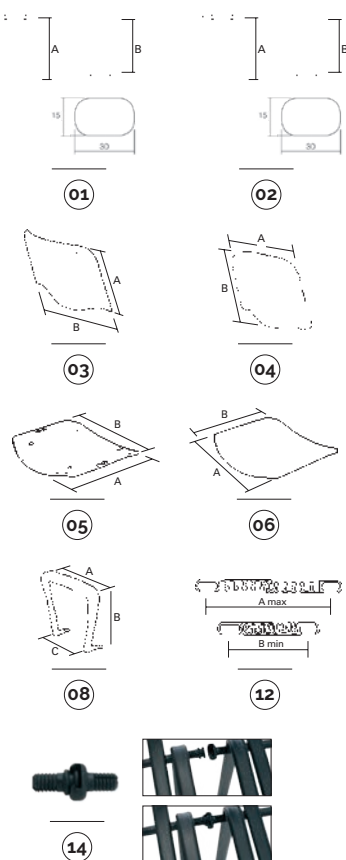
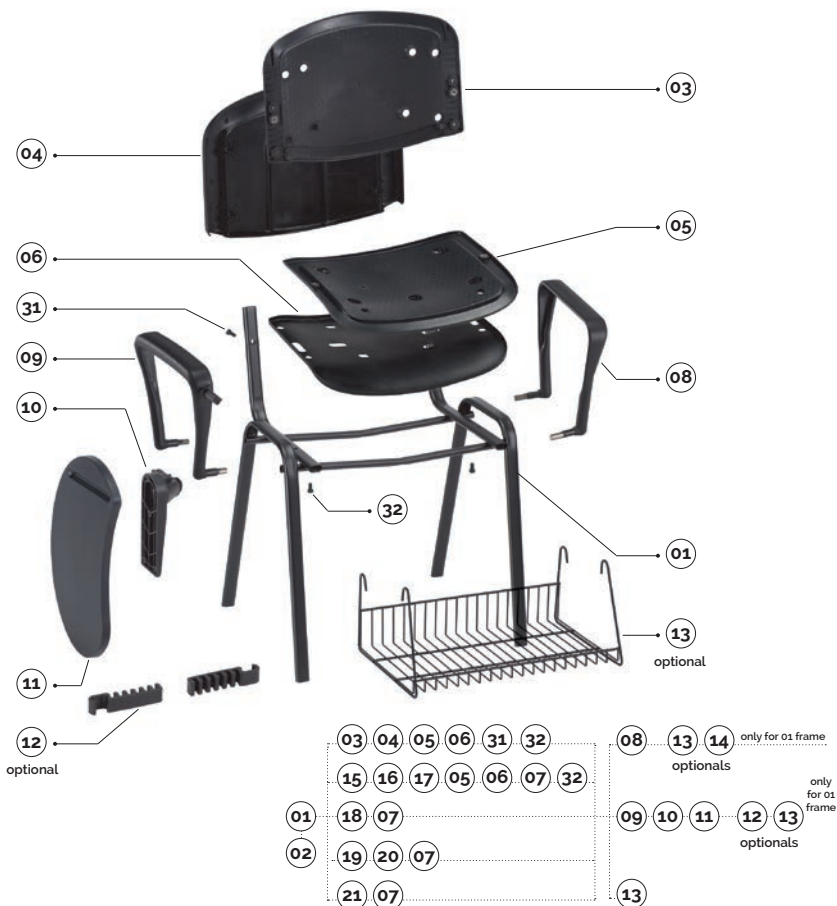

main component sizes

optionals

### 01 g2-telaio per sedia in tubo ovale 30x15 con tappi laterali e sottopiede montati

g2-chair frame in 30x15 oval tube with side and foot caps mounted

code	finishing	arm attach	q.kit	q.pack	a	b	kg.x1	vol.x1
112003-005	● nero/black	12	x1	160	450	425	3,00	mc. 0.021
112003-004	● nero/black	14	x1	160	450	425	3,00	mc. 0.021
112004-000	● grigio/grey	12	x1	160	450	425	3,00	mc. 0.021
112004-002	● grigio/grey	14	x1	160	450	425	3,00	mc. 0.021
112010-008	● cromato/chrome	12	x1	160	450	425	3,00	mc. 0.021
112010-005	● cromato/chrome	14	x1	160	450	425	3,00	mc. 0.021

### 02 g2-telaio per sedia in tubo ovale 30x15 con aggancio laterale in metallo saldato, con tappi laterali e sottopiede montati

g2-chair frame in 30x15 oval tube with metal lateral hook welded, side and foot caps mounted

code	finishing	arm attach	q.kit	q.pack	a	b	kg.x1	vol.x1
112003-016	● nero/black	12	x1	160	450	425	3,00	mc. 0.021
112003-015	● nero/black	14	x1	160	450	425	3,00	mc. 0.021
112004-007	● grigio/grey	12	x1	160	450	425	3,00	mc. 0.021
112004-008	● grigio/grey	14	x1	160	450	425	3,00	mc. 0.021
112010-016	● cromato/chrome	12	x1	160	450	425	3,00	mc. 0.021
112010-015	● cromato/chrome	14	x1	160	450	425	3,00	mc. 0.021

### 03 goshi-schienale interno in plastica

goshi-inner plastic back

code	finishing	q.kit	q.pack	a	b	kg.x1	vol.x1
132103-002	● nero/black	x1	40	330	470	0,60	mc. 0.004

### 04 goshe-coprischiena esterno in plastica

goshe-outer plastic back

code	finishing	q.kit	q.pack	a	b	kg.x1	vol.x1
132103-001	● nero/black	x1	30	475	335	0,40	mc. 0.004

### 05 gosdi-sedile interno in plastica

gosdi-inner plastic seat

code	finishing	q.kit	q.pack	a	b	kg.x1	vol.x1
132203-002	● nero/black	x1	30	460	400	0,80	mc. 0.004

### 06 gosde-sottosedile esterno plastica

gosde-outer plastic seat

code	finishing	q.kit	q.pack	a	b	kg.x1	vol.x1
132203-001	● nero/black	x1	80	410	465	0,40	mc. 0.003

### 31 vite tsp+ m6x20 zincata bianca

screw tsp+ m6x20 white zinc

code	finishing	q.kit
117711-203	● zincata bianca/white zinc	x2

### 32 vite tsp+ m6x25 zincata bianca

screw tsp+ m6x25 white zinc

code	finishing	q.kit
117711-199	● zincata bianca/white zinc	x2

### 08 gob-bracciolo in nylon

gob-nylon armrest

code	finishing	arm attach	q.kit	q.pack	a	b	c	kg.x1	vol.x1
131703-002	● nero/black	14	x2	20	290	250	190	0,80	mc. 0.0026
131703-004	● nero/black	12	x2	20	290	250	190	0,80	mc. 0.0026

### 12 coppia pinze regolabili per tubo ovale 15x30 pp

clips for oval tube 15x30 pp

code	finishing	q.kit	q.pack	a	b
134003-002	● nero/black	x1	200	214	134

### 13 g2c-cestello portariviste

g2c-magazine rack

code	finishing	q.kit	q.pack	kg.x1	vol.x1
113403-001	● nero/black	x1	25	0,975	mc. 0.03
113410-020	● cromato/chrome	x1	25	0,975	mc. 0.03

aggancio laterale maschio+femmina in plastica con 2 viti  
plastic lateral hook male+female with 2 screws  
134003-132

# 90

## 4-legs/tablet accessories

main component sizes



09

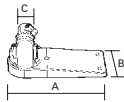

10

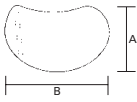

11

- 09 gobp-bracciolo in nylon con aggancio porta tavoletta  
gobp-nylon armrest with writing tablet hook

code	finishing	arm attach	q.kit	q.pack	a	b	c	d	kg.x1	vol.x1
131703-001	● nero/black	14	x1	20	290	250	190	15x15	0,80	mc. 0,0026
131703-003	● nero/black	12	x1	20	290	250	190	15x15	0,80	mc. 0,0026

- 10 spt2-snodo per tavoletta in termoplastica  
spt2-thermoplastic writing tablet articulation

code	finishing	q.kit	q.pack	a	b	c	kg.x1	vol.x1
134003-039	● nero/black	x1	20	180	66	15x15	0,35	mc. 0,0006

- 11 bean-tavoletta in termoplastico spessore 16 mm  
bean-16mm thick thermoplastic writing tablet

code	finishing	q.kit	q.pack	a	b	kg.x1	vol.x1
134003-044	● nero/black	x1	20	235	370	0,40	mc. 0,002

TLT tablet    TLT2 tablet    TLT3 tablet    BEAN tablet    TL02 tablet    SPT2 mechanism tablet    SPTA mechanism antipanic



for writing tablet options, see page 192/193

## 4-legs/backrest and seat options

main component sizes

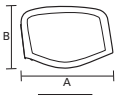

15

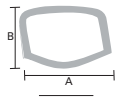

16

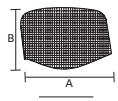

17



- 15 isonet-telaio schienale in plastica con viti per rete  
isonet-outer frame with screws for net

code	finishing	q.kit	q.pack	a	b	kg.x1	vol.x1
132103-003	● nero/black	x1	25	470	345	0,42	mc. 0,006

- 16 isonet-cornice schienale in plastica per rete  
isonet-open frame for isonet model

code	finishing	q.kit	q.pack	a	b	kg.x1	vol.x1
132103-004	● nero/black	x1	25	470	345	0,31	mc. 0,004

- 17 isonet-rete per schienale  
isonet-net for back

code	finishing	q.kit	q.pack	a	b	kg.x1	vol.x1
132105-500	○ bianco/white	x1	25	550	400	0,14	mc. 0,0057
132103-500	● nero/black	x1	25	550	400	0,14	mc. 0,0057
132102-500	● rosso/red	x1	25	550	400	0,14	mc. 0,0057

- 07 vite testa svasata croce m6x18 brunita nera-fissaggio sedile/ schienale faggio  
m6x18 black burnished flared philips screw-beech seat/backrest fixing

code	finishing	q.kit
117703-195	● nero/black	x4

and · 05 06 32

- 18 novx-sedile e schienale in plastica disponibili per telaio in tubo ovale e in tubo ellittico  
novx-plastic seat and backrest available for oval or elliptic tube frame

code	finishing	q.kit	q.pack	a	b	c	d	kg.x1	vol.x1
134002-001	● rosso/red    ral3002	x1	20	470	315	460	400	1,21	mc. 0,008
134003-119	● nero/black    ral9005	x1	20	470	315	460	400	1,21	mc. 0,008
134015-003	● blu/blue    ral5002	x1	20	470	315	460	400	1,21	mc. 0,008

and · 07

- 19 prisma-schienale e sedile in plastica disponibili per telaio in tubo ovale e in tubo ellittico  
prisma-plastic backrest and seat available for oval or elliptic tube frame

code	finishing	q.kit	q.pack	a	b	c	d	kg.x1	vol.x1
134003-110	● nero/black	x1	10	470	330	460	430	1,60	mc. 0,016

- 20 prisma-pannello sedile da tappezzare  
prisma-seat panel to upholster

code	finishing	q.kit	q.pack	a	b	kg.x1	vol.x1
132203-010	● nero/black	x1	20	400	400	0,40	mc. 0,004

and · 07

- 21 goshsdlf-schienale + sedile multistrato verniciato faggio + 4 testine  
goshsdlf-backrest + seat in painted planed beech plywood

code	finishing	q.kit	q.pack	a	b	c	d	e	f	kg.x1	vol.x1
124007-000	● faggio/beech-wood	x1	10	325	465	415	460	10	10	2,70	mc. 0,07

and · 07

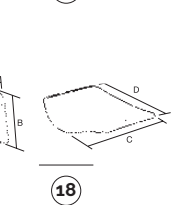

18

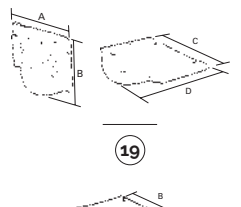

19

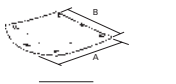

20

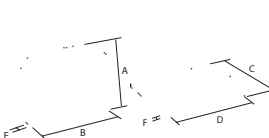

21



# 90

## 4-legs w/armrests

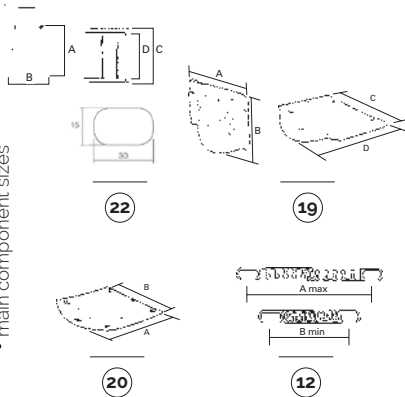
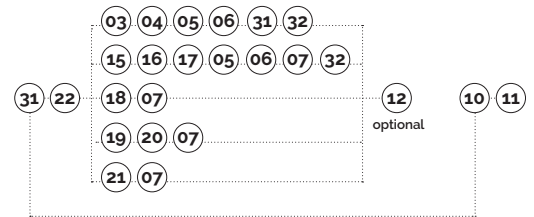

main component sizes

**22** 94-telaio per sedia in tubo ovale 30x15 con braccioli con tappi laterali e sottopiede montati  
94-chair frame in 30x15 oval tube with armrests, side and foot caps mounted

code	finishing	q.kit	q.pack	a	b	c	d	kg.x1	vol.x1
112003-020	● nero/black	x1	80	450	470	545	425	3,80	mc. 0,042
112004-021	● grigio/grey	x1	80	450	470	545	425	3,80	mc. 0,042
112010-040	● cromato/chrome	x1	80	450	470	545	425	3,80	mc. 0,042

**19** prisma-schienale e sedile in plastica disponibili per telaio in tubo ovale e in tubo ellittico  
prisma-plastic backrest and seat available for oval or elliptic tube frame

code	finishing	q.kit	q.pack	a	b	c	d	kg.x1	vol.x1
134003-110	● nero/black	x1	10	470	330	460	430	1,60	mc. 0,016

**20** prisma-pannello sedile da tappezzare  
prisma-seat panel to upholster

code	finishing	q.kit	q.pack	a	b	kg.x1	vol.x1
132203-010	● nero/black	x1	20	400	400	0,40	mc. 0,004

**07** vite testa svasata croce m6x18 brunita nera-fissaggio sedile/ schienale faggio  
m6x18 black burnished flared philips screw-beech seat/backrest fixing

code	finishing	q.kit
117703-195	● nero/black	x4

**12** coppia pinze regolabili per tubo ovale 15x30 pp  
clips for oval tube 15x30 pp

code	finishing	q.kit	q.pack	a	b
134003-002	● nero/black	x1	200	214	134

# 90

## 4-legs with armrests/tablet accessories

main component sizes

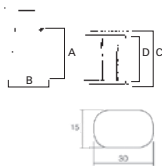

aggancio tavoletta  
tablet hook

31

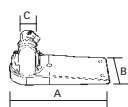

10

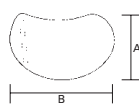

11

- 31 94-telaio per sedia in tubo ovale 30x15 con braccioli per tavoletta  
94-chair frame in 30x15 oval tube with armrests for writing tablet

code	finishing	q.kit	q.pack	a	b	c	d	kg.x1	vol.x1
112003-022	● nero/black	x1	80	450	470	545	425	3,80	mc. 0.042
112004-022	● grigio/grey	x1	80	450	470	545	425	3,80	mc. 0.042
112010-043	● cromato/chrome	x1	80	450	470	545	425	3,80	mc. 0.042

- 10 spt2-snodo per tavoletta in termoplastica  
spt2-thermoplastic writing tablet articulation

code	finishing	q.kit	q.pack	a	b	c	kg.x1	vol.x1
134003-039	● nero/black	x1	20	180	66	15x15	0,35	mc. 0.0006

- 11 bean-tavoletta in termoplastico spessore 16 mm  
bean-16mm thick thermoplastic writing tablet

code	finishing	q.kit	q.pack	a	b	kg.x1	vol.x1
134003-044	● nero/black	x1	20	235	370	0,40	mc. 0.002

TLT tablet    TLT2 tablet    TLT3 tablet    BEAN tablet    TL02 tablet    SPT2 mechanism tablet    SPTA mechanism antipanic



for writing tablet options, see page 192/193

## 4-legs with armrests/backrest and seat options

main component sizes

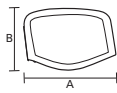

15

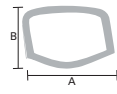

16

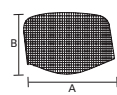

17



- 15 isonet-telaio schienale in plastica con viti per rete  
isonet-outer frame with screws for net

code	finishing	q.kit	q.pack	a	b	kg.x1	vol.x1
132103-003	● nero/black	x1	25	470	345	0,42	mc. 0.006

- 16 isonet-cornice schienale in plastica per rete  
isonet-open frame for isonet model

code	finishing	q.kit	q.pack	a	b	kg.x1	vol.x1
132103-004	● nero/black	x1	25	470	345	0,31	mc. 0.004

- 17 isonet-rete per schienale  
isonet-net for back

code	finishing	q.kit	q.pack	a	b	kg.x1	vol.x1
132105-500	○ bianco/white	x1	25	550	400	0,14	mc. 0.0057
132103-500	● nero/black	x1	25	550	400	0,14	mc. 0.0057
132102-500	● rosso/red	x1	25	550	400	0,14	mc. 0.0057

and .. 05 06 07 32

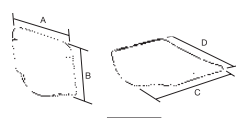

18



- 18 novx-sedile e schienale in plastica disponibili per telaio in tubo ovale e in tubo ellittico  
novx-plastic seat and backrest available for oval or elliptic tube frame

code	finishing	q.kit	q.pack	a	b	c	d	kg.x1	vol.x1
134002-001	● rosso/red    ral3002	x1	20	470	315	460	400	1,21	mc. 0.008
134003-119	● nero/black    ral9005	x1	20	470	315	460	400	1,21	mc. 0.008
134015-003	● blu/blue    ral5002	x1	20	470	315	460	400	1,21	mc. 0.008

and .. 07



03



- 03 goshi-schienale interno in plastica  
goshi-inner plastic back

code	finishing	q.kit	q.pack	a	b	kg.x1	vol.x1
132103-002	● nero/black	x1	40	330	470	0,60	mc. 0.004

- 04 goshe-coprischienale esterno in plastica  
goshe-outer plastic back

code	finishing	q.kit	q.pack	a	b	kg.x1	vol.x1
132103-001	● nero/black	x1	30	475	335	0,40	mc. 0.004

and .. 05 06 31 32

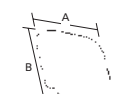

04

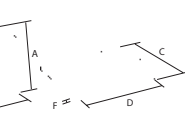

21



- 21 goshsdif-schienale + sedile multistrato verniciato faggio + 4 testine  
goshsdif-backrest + seat in painted planed beech plywood

code	finishing	q.kit	q.pack	a	b	c	d	e	f	kg.x1	vol.x1
124007-000	● faggio/beech-wood	x1	10	325	465	415	460	10	10	2,70	mc. 0.07

and .. 07

# 90 slide

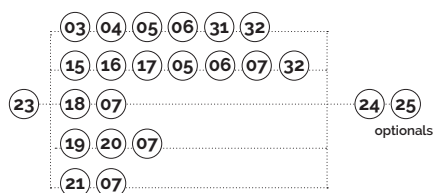
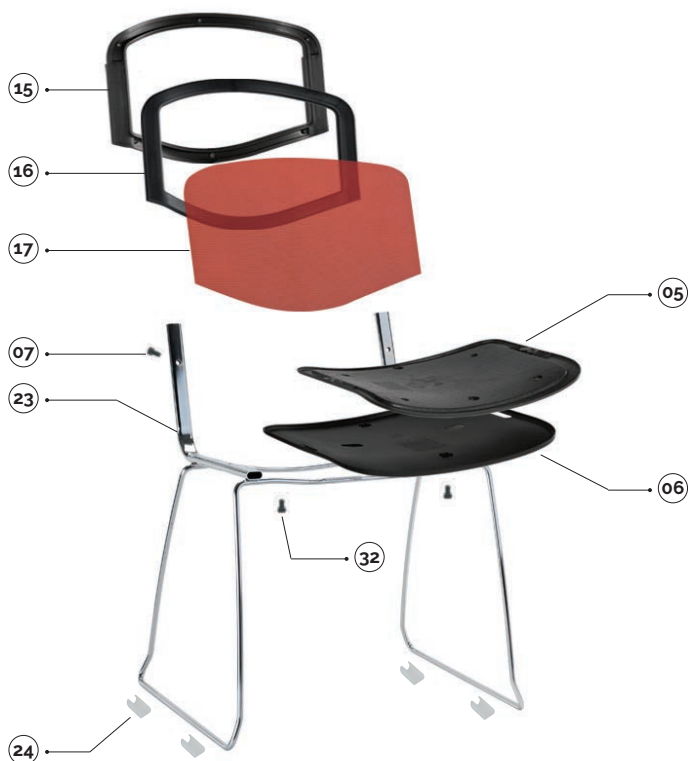

main component sizes

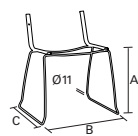

23

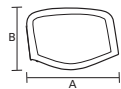

15

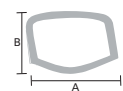

16

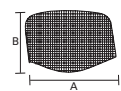

17

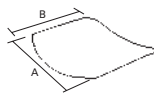

05

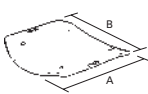

06



24



25

optionals

**23** spritz-telaio chiuso in tondino d.11 tappi esclusi  
spritz-sled wire frame d.11 caps excluded

code	finishing	q.kit	q.pack	a	b	c	kg.x1	vol.x1
112010-250	● cromato/chrome	x1	100	450	580	470	4,00	mc. 0,042

**24** confezione di basi a pinza antirotazione per tondino colore neutro  
neutral clips base for wire d.11 package

code	finishing	q.kit	q.pack
137006-070	○ neutro/neutral	x4	200

**25** base piana a pinza doppia  
double flat clip base

code	finishing	q.kit
134006-021	○ neutro/neutral	x4

**15** isonet-telaio schienale in plastica con viti per rete  
isonet-outer frame with screws for net

code	finishing	q.kit	q.pack	a	b	kg.x1	vol.x1
132103-003	● nero/black	x1	25	470	345	0,42	mc. 0,006

**16** isonet-cornice schienale in plastica per rete  
isonet-open frame for isonet model

code	finishing	q.kit	q.pack	a	b	kg.x1	vol.x1
132103-004	● nero/black	x1	25	470	345	0,31	mc. 0,004

**17** isonet-rete per schienale  
isonet-net for back

code	finishing	q.kit	q.pack	a	b	kg.x1	vol.x1
132105-500	○ bianco/white	x1	25	550	400	0,14	mc. 0,0057
132103-500	● nero/black	x1	25	550	400	0,14	mc. 0,0057
132102-500	● rosso/red	x1	25	550	400	0,14	mc. 0,0057

**05** gosdi-sedile interno in plastica  
gosdi-inner plastic seat

code	finishing	q.kit	q.pack	a	b	kg.x1	vol.x1
132203-002	● nero/black	x1	30	460	400	0,80	mc. 0,004

**06** gosde-sottosedile esterno plastica  
gosde-outer plastic seat

code	finishing	q.kit	q.pack	a	b	kg.x1	vol.x1
132203-001	● nero/black	x1	80	410	465	0,40	mc. 0,003

**07** vite testa svasata croce m6x18 brunita nera-fissaggio sedile/ schienale faggio  
m6x18 black burnished flared philips screw-beech seat/backrest fixing

code	finishing	q.kit
117703-195	● nero/black	x4

**32** vite tsp+ m6x25 zincata bianca  
screw tsp+ m6x25 white zinc

code	finishing	q.kit
117711-199	● zincata bianca/white zinc	x2

# 90

## slide/backrest and seat options

main component sizes

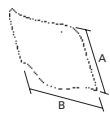

03

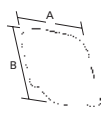

04



**03** goshi-schienale interno in plastica  
goshi-inner plastic back

code	finishing	q.kit	q.pack	a	b	kg.x1	vol.x1
132103-002	● nero/black	x1	40	330	470	0,60	mc. 0,004

**04** goshe-coprischienale esterno in plastica  
goshe-outer plastic back

code	finishing	q.kit	q.pack	a	b	kg.x1	vol.x1
132103-001	● nero/black	x1	30	475	335	0,40	mc. 0,004

and .. 05 06 31 32

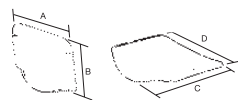

18



**18** novx-sedile e schienale in plastica disponibili per telaio in tubo ovale e in tubo ellittico  
novx-plastic seat and backrest available for oval or elliptic tube frame

code	finishing	q.kit	q.pack	a	b	c	d	kg.x1	vol.x1
134002-001	● rosso/red ral3002	x1	20	470	315	460	400	1,21	mc. 0,008
134003-119	● nero/black ral9005	x1	20	470	315	460	400	1,21	mc. 0,008
134015-003	● blu/blue ral5002	x1	20	470	315	460	400	1,21	mc. 0,008

and .. 07



19



**19** prisma-schienale e sedile in plastica disponibili per telaio in tubo ovale e in tubo ellittico  
prisma-plastic backrest and seat available for oval or elliptic tube frame

code	finishing	q.kit	q.pack	a	b	c	d	kg.x1	vol.x1
134003-110	● nero/black	x1	10	470	330	460	430	1,60	mc. 0,016

**20** prisma-pannello sedile da tappezzare  
prisma-seat panel to upholster

code	finishing	q.kit	q.pack	a	b	kg.x1	vol.x1
132203-010	● nero/black	x1	20	400	400	0,40	mc. 0,004

and .. 07



21



**21** goshsdlf-schienale + sedile multistrato verniciato faggio + 4 testine  
goshsdlf-backrest + seat in painted planed beech plywood

code	finishing	q.kit	q.pack	a	b	c	d	e	f	kg.x1	vol.x1
124007-000	● faggio/beech-wood	x1	10	325	465	415	460	10	10	2,70	mc. 0,07

and .. 07



# 90 swivel

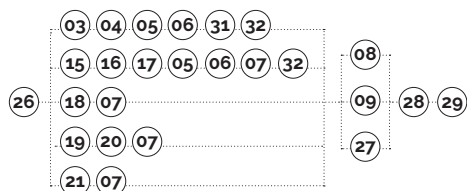

main component sizes

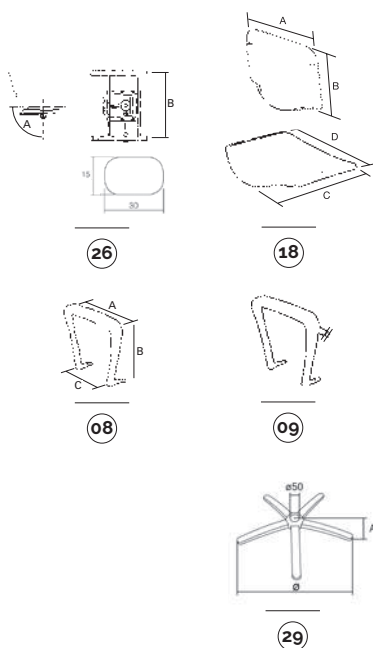

**26** g2gv-telaio per sedia girevole in tubo ovale 30x15 con piastra comando a gas compresso di spatola, tappi esclusi  
g2gv-swivel chair frame in 30x15 oval tube with gas control plate incl. spatula, excluding caps

code	finishing	arm attach	q.kit	q.pack	a	b	kg.x1	vol.x1
112003-200	● nero/black	14	x1	200	87"	425	2.62	mc. 0.015
112003-201	● nero/black	12	x1	200	87"	425	2.62	mc. 0.015
112010-200	● cromato/chrome	14	x1	200	87"	425	2.62	mc. 0.015
112010-201	● cromato/chrome	12	x1	200	87"	425	2.62	mc. 0.015

**18** novx-sedile e schienale in plastica disponibili per telaio in tubo ovale e in tubo ellittico  
novx-plastic seat and backrest available for oval or elliptic tube frame

code	finishing	q.kit	q.pack	a	b	c	d	kg.x1	vol.x1
134002-001	● rosso/red	ral3002	x1	20	470	315	460 400	1.21	mc. 0.008
134003-119	● nero/black	ral9005	x1	20	470	315	460 400	1.21	mc. 0.008
134015-003	● blu/blue	ral5002	x1	20	470	315	460 400	1.21	mc. 0.008

**08** gob-bracciolo in nylon  
gob-nylon armrest

code	finishing	arm attach	q.kit	q.pack	a	b	c	kg.x1	vol.x1
131703-002	● nero/black	14	x2	20	290	250	190	0.80	mc. 0.0026
131703-004	● nero/black	12	x2	20	290	250	190	0.80	mc. 0.0026

**09** gobp-bracciolo in nylon con aggancio porta tavoletta  
gobp-nylon armrest with writing tablet hook

code	finishing	arm attach	q.kit	q.pack	a	b	c	d	kg.x1	vol.x1
131703-001	● nero/black	14	x1	20	290	250	190	15x15	0.80	mc. 0.0026
131703-003	● nero/black	12	x1	20	290	250	190	15x15	0.80	mc. 0.0026

**07** vite testa svasata croce m6x18 brunita nera-fissaggio sedile/ schienale faggio  
m6x18 black burnished flared philips screw-beech seat/backrest fixing

code	finishing	q.kit
117703-195	● nero/black	x4

**27** confezione tappi copritesta d.18 neri  
black cover head caps d.18 package

code	finishing	diameter	q.kit	q.pack
137003-070	● nero/black	ø18	x4	200
134103-151	● nero/black	ø15	x4	

**28** confezione tappi copritesta ovali 30x15 neri  
black oval cover head caps 30x15 package

code	finishing	q.kit	q.pack
137003-071	● nero/black	x4	200

**29** b40 base in metallo d.640 con coprisaldatura  
b40 metal base d.640 with cover welding

code	finishing	q.kit	q.pack	a	ø	kg.x1	vol.x1
110210-027	● cromato/chrome	x1	5	60	640	2.85	mc. 0.014



# 90

## swivel/backrest and seat options

main component sizes

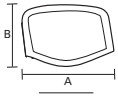

15

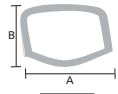

16

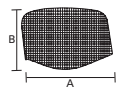

17



- 15** isonet-telaio schienale in plastica con viti per rete  
isonet-outer frame with screws for net

code	finishing	q.kit	q.pack	a	b	kg.x1	vol.x1
132103-003	● nero/black	x1	25	470	345	0,42	mc. 0,006

- 16** isonet-cornice schienale in plastica per rete  
isonet-open frame for isonet model

code	finishing	q.kit	q.pack	a	b	kg.x1	vol.x1
132103-004	● nero/black	x1	25	470	345	0,31	mc. 0,004

- 17** isonet-rete per schienale  
isonet-net for back

code	finishing	q.kit	q.pack	a	b	kg.x1	vol.x1
132105-500	○ bianco/white	x1	25	550	400	0,14	mc. 0,0057
132103-500	● nero/black	x1	25	550	400	0,14	mc. 0,0057
132102-500	● rosso/red	x1	25	550	400	0,14	mc. 0,0057

and · (05) (06) (07) (32)



03

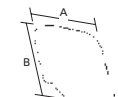

04



- 03** goshi-schienale interno in plastica  
goshi-inner plastic back

code	finishing	q.kit	q.pack	a	b	kg.x1	vol.x1
132103-002	● nero/black	x1	40	330	470	0,60	mc. 0,004

- 04** goshe-coprischienale esterno in plastica  
goshe-outer plastic back

code	finishing	q.kit	q.pack	a	b	kg.x1	vol.x1
132103-001	● nero/black	x1	30	475	335	0,40	mc. 0,004

and · (05) (06) (31) (32)



19

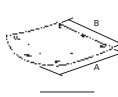

20



- 19** prisma-schienale e sedile in plastica disponibili per telaio in tubo ovale e in tubo ellittico  
prisma-plastic backrest and seat available for oval or elliptical tube frame

code	finishing	q.kit	q.pack	a	b	c	d	kg.x1	vol.x1
134003-110	● nero/black	x1	10	470	330	460	430	1,60	mc. 0,016

- 20** prisma-pannello sedile da tappezzare  
prisma-seat panel to upholster

code	finishing	q.kit	q.pack	a	b	kg.x1	vol.x1
132203-010	● nero/black	x1	20	400	400	0,40	mc. 0,004

and · (07)

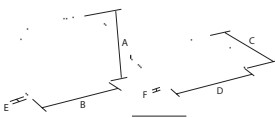

21



- 21** goshsdlf-schienale + sedile multistrato verniciato faggio + 4 testine  
goshsdlf-backrest + seat in painted planed beech plywood

code	finishing	q.kit	q.pack	a	b	c	d	e	f	kg.x1	vol.x1
124007-000	● faggio/beech-wood	x1	10	325	465	415	460	10	10	2,70	mc. 0,07

and · (07)

# 90 bench



CERTIFIED BY  
**CATAS**

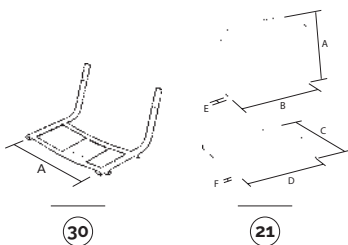
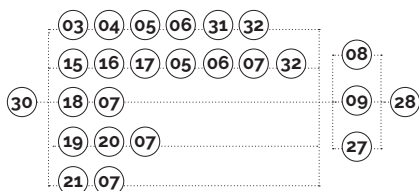

### 30 g2pv-telaio in tubo ovale o ellittico per panca verniciata

code	finishing	arm attach	q.kit	q.pack	a	kg.x1	vol.x1
110703-061	● nero/black	12 ovale/oval	x1	200	425	2,20	mc. 0.015
110703-062	● nero/black	14 ovale/oval	x1	200	425	2,20	mc. 0.015

### 21 g0shsdlf-schienale + sedile multistrato verniciato faggio + 4 testine

code	finishing	q.kit	q.pack	a	b	c	d	e	f	kg.x1	vol.x1
124007-000	● faggio/beech-wood	x1	10	325	465	415	460	10	10	2,70	mc. 0.07

### 07 vite testa svasata croce m6x18 brunita nera-fissaggio sedile/ schienale faggio

code	finishing	q.kit
117703-195	● nero/black	x4

### 27 confezione tappi copritesta d.18 neri

code	finishing	diameter	q.kit	q.pack
137003-070	● nero/black	ø18	x4	200
134103-151	● nero/black	ø15	x4	

### 28 confezione tappi copritesta ovali 30x15 neri

code	finishing	q.kit	q.pack
137003-071	● nero/black	x4	200

main component sizes

OPTIONAL  
bench  
connector

E-USB **NEW**  
bench plug



JIM **NEW**  
bench leg

APOLL  
bench arm



plastic

90GM  
bench leg

90GF  
bench leg

100GM  
bench leg

200GM  
bench leg

PIONEER  
bench arm



metal

CUT  
bench leg

SLIM  
bench leg

CUT  
bench arm

SLIM  
bench arm



aluminium

for the bench components, see page 201

optionals



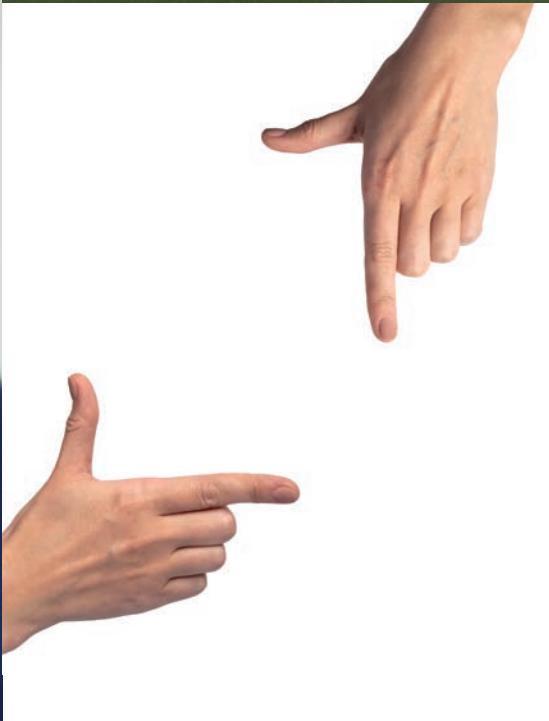



**vicenza**

---



# vicenza



---

slide

4 legs  
4 legs w/armrests  
4 legs w/writing tablet

swivel

bench





# vicenza

4-legs



plastic colours

- rosso/red ral 3002
- nero/black
- blu/blue ral 5002

main component sizes

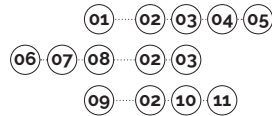
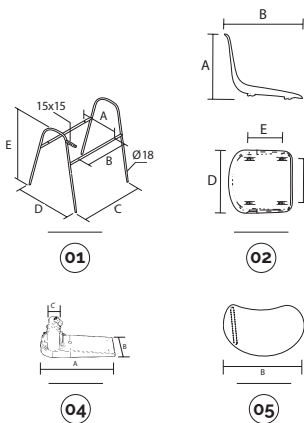

**01** vicenza-sgabello per scocca vicenza con porta tav. e bracc. in tubo ø18 tappi montati  
vicenza-stool for vicenza with mechanism for little table and arms shell pipe ø18 inner feet caps assembled

code	finishing	q.kit	q.pack	a	b	c	kg.x1	vol.x1
111903-007	● nero/black	x1	80	480	440	610	2.0	mc. 0.017
111910-012	● cromato/chrome	x1	80	480	440	610	2.0	mc. 0.017

**02** vicenza-scocca intera  
vicenza-plastic shell

code	finishing	q.kit	q.pack	a	b	c	d	e	kg.x1	vol.x1
133902-002	● rosso/red ral 3002	x2	12	395	470	315	430	255	1.30	mc. 0.014

**03** confezione viti hilo d.5x35 testa svasata a croce zincate (vite fissaggio scocca)  
screws auto-thread 5x35 flared cross head zinc for shell fixing package

code	finishing	q.kit	q.pack
117011-070	● zincata/zinc	x4	200

**04** spt2-snodo per tavoletta in tempoplastica  
spt2-mechanism for writing tablet

code	finishing	q.kit	q.pack	a	b	c	kg.x1	vol.x1
134003-039	● nero/black	x1	20	180	66	15x15	0.35	mc. 0.0006

**05** bean-tavoletta in termoplastico spessore 16 mm  
bean-writing tablet in plastic thickness 16 mm

code	finishing	q.kit	q.pack	a	b	kg.x1	vol.x1
134003-044	● nero/black	x1	20	235	370	0.40	mc. 0.002



vicenza-carrello portasedie con accessori nero  
vicenza-trolley for chairs with accessories black

code	finishing
110803-365	● nero/black



for all colour codes, see page 93

TLT tablet    TLT2 tablet    TLT3 tablet    BEAN tablet    TL02 tablet    SPT2 mechanism tablet    SPTA mechanism antipanic



for writing tablet options, see page 192/193

# vicenza

## frame options



06

07

08

09



06



07



08

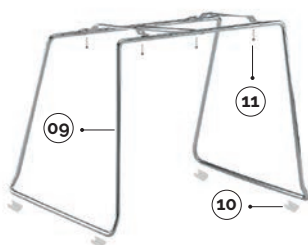

09

11

10

**06** vicenza-sgabello per scocca con braccioli in tubo ø18 tappi sottopiede montati  
vicenza-stool with arms for shell pipe ø18 inner feet caps assembled

code	finishing	q.kit	q.pack	a	b	c	d	e	kg.x1	vol.x1
111903-003	● nero/black	x1	80	255	315	486	500	630	2,50	mc. 0,040
111910-010	● cromato/chrome	x1	80	255	315	486	500	630	2,50	mc. 0,040

**07** vicenza-sgabello per scocca con aggancio in tubo tappi sottopiede montati  
vicenza-stool with hook for shell pipe inner feet caps assembled

code	finishing	diameter	q.kit	q.pack	a	b	c	d	e	f	kg.x1	vol.x1
111903-001	● nero/black	18	x1	200	255	315	500	480	460	438	1,90	mc. 0,020
111910-002	● cromato/chrome	18	x1	200	255	315	500	480	460	438	1,90	mc. 0,020
111903-249	● nero/black	20	x1	200	255	315	505	484	460	438	2,05	mc. 0,020
111910-249	● cromato/chrome	20	x1	200	255	315	505	484	460	438	2,05	mc. 0,020
111903-253	● nero/black	22	x1	200	255	315	510	484	460	438	2,30	mc. 0,020
111910-253	● cromato/chrome	22	x1	200	255	315	510	484	460	438	2,30	mc. 0,020

**08** vicenza-sgabello per scocca in tubo tappi sottopiede montati  
vicenza-stool for shell pipe inner feet caps assembled

code	finishing	diameter	q.kit	q.pack	a	b	c	d	e	f	kg.x1	vol.x1
111903-002	● nero/black	18	x1	200	255	315	500	478	460	438	1,85	mc. 0,020
111910-001	● cromato/chrome	18	x1	200	255	315	500	478	460	438	1,85	mc. 0,020
111903-248	● nero/black	20	x1	200	255	315	505	484	460	438	2,00	mc. 0,020
111910-248	● cromato/chrome	20	x1	200	255	315	505	484	460	438	2,00	mc. 0,020
111903-252	● nero/black	22	x1	200	255	315	510	484	460	438	2,25	mc. 0,020
111910-252	● cromato/chrome	22	x1	200	255	315	510	484	460	438	2,25	mc. 0,020

**09** filo-telaio in tondino d.11  
filo-slide wire frame d.11

code	finishing	q.kit	q.pack	a	b	c	kg.x1	vol.x1
113410-010	● cromato/chrome	x1	100	470	540	480	3,10	mc. 0,04

**10** confezione di basi a pinza antirotazione per tondino colore neutro  
neutral clips base for wire d.11 package

code	finishing	q.kit	q.pack
137006-070	○ neutro/neutral	x4	200

**11** vite autoflettante truciolare tc\* ø 5,5x19 per fissaggio sedile  
screw chipboard tc\* ø 5,5x19 for fixing seat

code	finishing	q.kit
117811-180	○ zincata/zinc	x4

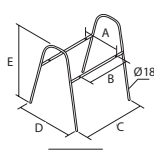

06

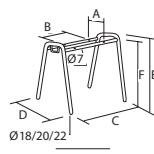

07

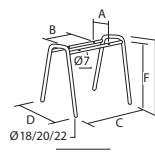

08

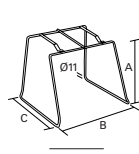

09

# vicenza

## swivel



plastic colours

- rosso/red ral 3002
- nero/black
- blu/blue ral 5002

main component sizes

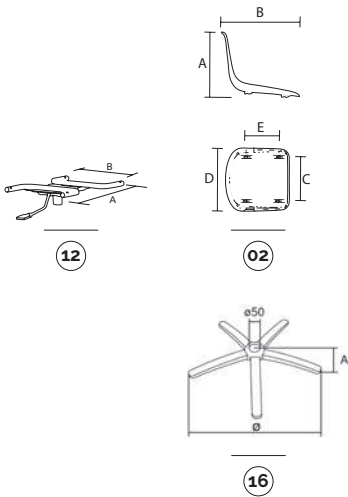

12 02 03 13 14 16  
optional

**12** vicenza gnr-supporto girevole a gas senza accessori  
vicenza gnr-swivel metal frame for gas lift without accessories

code	finishing	q.kit	q.pack	a	b	kg.x1	vol.x1
110903-006	● nero/black	x1	10	315	255	1,40	mc. 0.004

**02** vicenza-scocca intera  
vicenza-plastic shell

code	finishing	q.kit	q.pack	a	b	c	d	e	kg.x1	vol.x1
133902-002	● rosso/red ral 3002	x2	12	395	470	315	430	255	1,30	mc. 0.014

**03** confezione viti hilo d.5x35 testa svasata a croce zincate (vite fissaggio scocca)  
screws auto-thread 5x35 flared cross head zinc for shell fixing package

code	finishing	q.kit	q.pack
117011-070	● zincata/zinc	x4	200

**13** confezione tappi copritesta d.18 neri  
black cover head caps d.18 package

code	finishing	q.kit	q.pack
137003-070	● nero/black	x4	200

**14** cpg-copertina in plastica per telaio girevole  
cpg-plastic cover for swivel frame

code	finishing	q.kit	q.pack	a	b	c	d	ø	kg.x1	vol.x1
130903-000	● nero/black	x1	50	60	200	210	167	36	0,1	mc. 0.0015

**16** b40 base in metallo d.640 con coprisaldatura  
b40 metal base d.640 with cover welding

code	finishing	q.kit	q.pack	a	ø	kg.x1	vol.x1
110210-027	● cromato/chrome	x1	5	60	640	2,85	mc. 0.014

optional

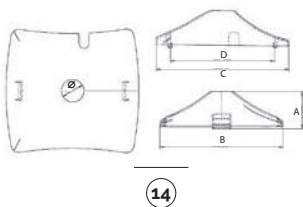

CPG  
plastic cover for swivel frame



for all colour codes, see page 93

# vicenza

bench



plastic colours

- rosso/red ral 3002
- nero/black
- blu/blue ral 5002

15 02 03 13

main component sizes

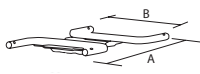

15

15 supporto per attacco scocca vicenza su panca  
bench frame for pull shell

code	finishing	q.kit	q.pack	a	b	kg.x1	vol.x1
110703-016	● nero/black	x1	10	315	255	1.40	mc. 0.004

for the components below, see page 28

02 03 13



for all colour codes, see below

for the bench components, see page 201

optionals

OPTIONAL  
bench  
connector



E-USB NEW  
bench plug



JIM NEW  
bench leg



APOLL  
bench arm



plastic

90GM  
bench leg



90GF  
bench leg



100GM  
bench leg



200GM  
bench leg



PIONEER  
bench arm



metal

CUT  
bench leg



SLIM  
bench leg



CUT  
bench arm



SLIM  
bench arm



aluminium

## vicenza

optional colour codes

### shell colour codes



02 scocche in plastica  
plastic shells

- 133902-002 rosso/red ral 3002
- 133903-001 nero/black
- 133915-005 blu/blue ral 5002





BEYOND **Solutions**

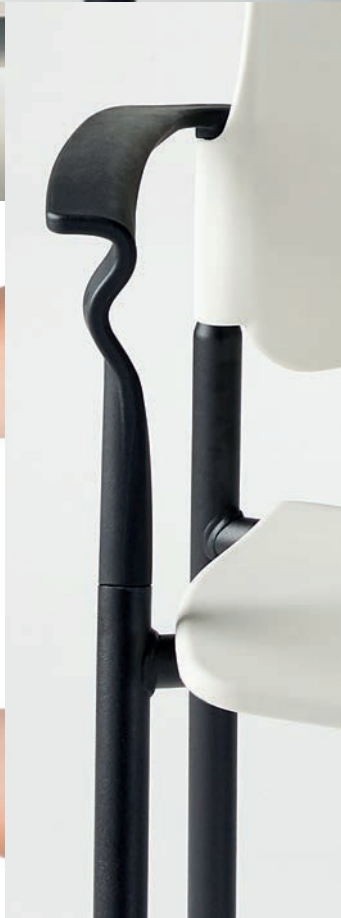



**pinko**



# pinko



---

side

4 legs

4 legs with castors

swivel

folding bench  
bench



## pinko showing

---

### features



trolley  
available



**L'ampia e confortevole seduta**, unita all'elevato numero di opzioni e versioni di telai e componenti disponibili, la rendono ideale per qualsiasi utilizzo in **ambiente Office e Educational**.

Ma non solo, la **panca con sedile ribaltabile** completa un assortimento vario e completo, rendendo **Pinko** adatto anche all'**ambiente Community**.

*The large and comfortable seat, combined with the generous selection of options and versions of frames and components available make it ideal for use in any **Office and Educational environments**.*

*But its versatility doesn't end there: **the bench version with folding seat** rounds off a range which is both varied and complete, making **Pinko** suitable also for **Community environments**.*

# pinko

4-legs

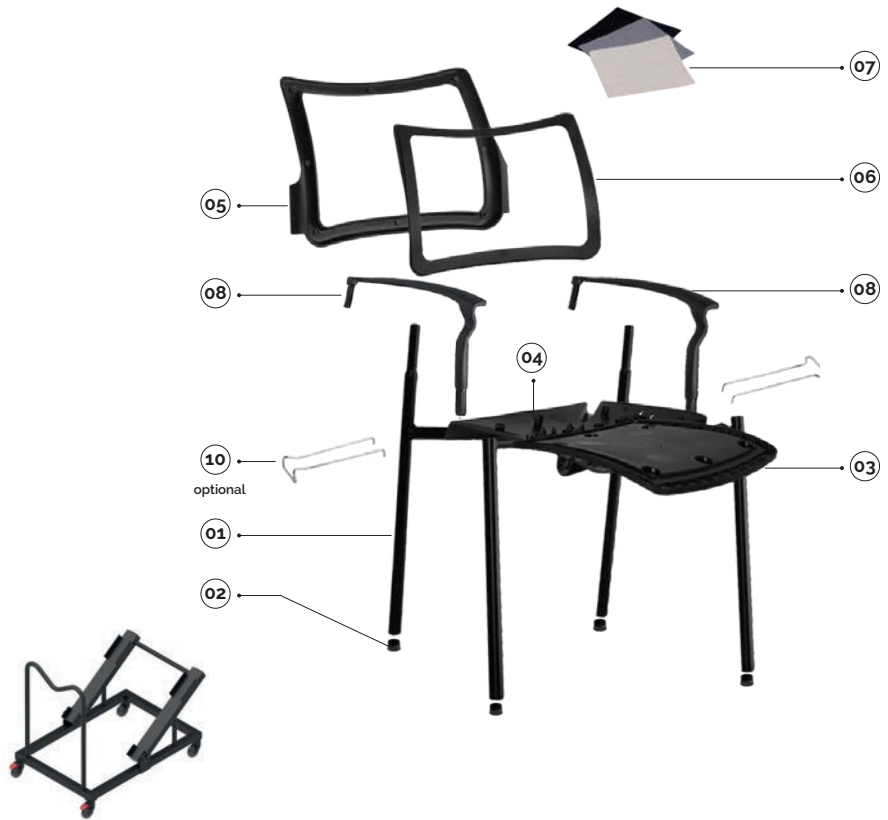

pinko-carrello portasedie con accessori  
pinko-trolley for chairs with accessories

code	finishing	q.kit
110803-340	● nero/black	x1

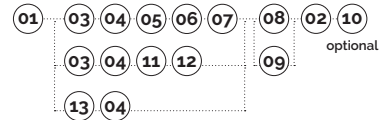

- blu/blue ral5002
- nero/black
- grigio/grey ral7035

plastic colours

## 01 pinko-telaio quattro gambe fisso per braccioli senza tappi pinko-fixed four legs frame for arms without caps

code	finishing	q.kit	q.pack	a	b	c	kg.x1	vol.x1
112603-040	● nero/black	x1	80	450	530	530	3,20	mc. 0.035
112604-040	● grigio/grey	x1	80	450	530	530	3,20	mc. 0.035
112610-040	● cromato/chrome	x1	80	450	530	530	3,20	mc. 0.035

## 02 confezione puntali a testa sferica d.25 cap d.25 spherical head black package

code	finishing	q.kit	q.pack
137003-075	● nero/black	x4	120

## 03 pinko-sedile interno da tappezzare pinko-inner seat for upholstery

code	finishing	q.kit	q.pack	a	b	kg.x1	vol.x1
132203-025	● nero/black	x1	10	465	470	0,73	mc. 0.006

## 04 pinko-sedile esterno plastica pinko-outer plastic seat

code	finishing	q.kit	q.pack	a	b	kg.x1	vol.x1
132203-026	● nero/black	x1	20	465	470	0,62	mc. 0.007

## 05 pinko-telaio schienale in plastica per rete (portante) + 2 tappi schienale + 2 tappi sedile pinko-back frame in plastic for mesh + 2 back caps + 2 seat caps

code	finishing	q.kit	q.pack	a	b	kg.x1	vol.x1
132103-027	● nero/black	x2	20	345	495	0,50	mc. 0.0045

## 06 pinko-cornice schienale in plastica per rete pinko-net frame in plastic for mesh

code	finishing	q.kit	q.pack	a	b	kg.x1	vol.x1
132103-028	● nero/black	x1	10	345	495	0,35	mc. 0.0057

## 07 pinko-rete per schienale pinko-net for pinko back

code	finishing	q.kit	q.pack	a	b	kg.x1	vol.x1
132105-501	○ bianco/white	x1	25	460	520	0,14	mc. 0.0057
132103-501	● nero/black	x1	25	460	520	0,14	mc. 0.0057
132104-501	● grigio/grey	x1	25	460	520	0,14	mc. 0.0057

## 08 pinko-coppia braccioli dx/sx in plastica pinko-pair of plastic arms right/left

code	finishing	q.kit	q.pack	kg.x1	vol.x1
131703-050	● nero/black	x1	10	0,66	mc. 0.0037

## 10 pinko/logan-coppia agganci laterale maschio + femmina cromati pinko/logan-chrome lateral hooks male + femal with screws

code	finishing	q.kit	q.pack	kg.x1	vol.x1
113410-100	● cromato/chrome	x1	100	0,13	mc. 0.0004

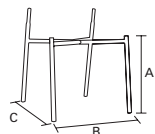

01

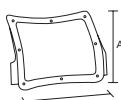

05

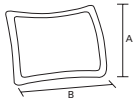

06

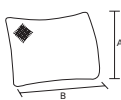

07

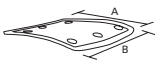

03



04



08



10

main component sizes

optionals

# pinko

## 4-legs/tablet accessories

main component sizes



09



### 09 pinko-coppia braccioli + gancio portavoletta destro in plastica pinko-pair of plastic arms right/left with joint for writing tablet

code	finishing	q.kit	q.pack	kg.x1	vol.x1
131703-051	● nero/black	x1	10	0,70	mc. 0,0037

TLT  
tablet



TLT2  
tablet



TLT3  
tablet



BEAN  
tablet



TL02  
tablet



SPT2  
mechanism tablet



SPTA  
mechanism antipanic



for writing tablet options, see page 192/193

## 4-legs/seat and backrest options

main component sizes

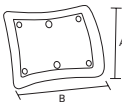

11

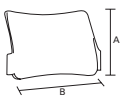

12



### 11 pinko-schienale interno da tappezzare pinko-inner back for upholstery

code	finishing	q.kit	q.pack	a	b	kg.x1	vol.x1
132103-025	● nero/black	x1	20	350	495	0,62	mc. 0,009

### 12 pinko-schienale esterno plastica + 2 tappi schienale + 2 tappi sedile pinko-outer plastic back + 2 back caps + 2 seat caps

code	finishing	q.kit	q.pack	a	b	kg.x1	vol.x1
132103-026	● nero/black	x1	10	350	495	0,25	mc. 0,0045

and 03 04

main component sizes

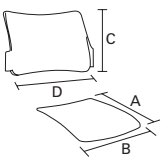

13



### 13 pinko-sedile/schienale in plastica colorato a vista + 2 tappi schienale + 2 tappi sedile pinko-plastic seat/back coloured at sight + 2 back caps + 2 seat caps

code	finishing	q.kit	q.pack	a	b	c	d	kg.x1	vol.x1	
134015-108	● blu/blue	ral 5002	x1	10	470	465	350	495	1,78	mc. 0,014
134003-108	● nero/black		x1	10	470	465	350	495	1,78	mc. 0,014
134004-109	● grigio/grey	ral 7035	x1	10	470	465	350	495	1,78	mc. 0,014

and 04

# pinko

## 4-legs for castors



plastic colours

- blu/blue ral5002
- nero/black
- grigio/grey ral7035

main component sizes

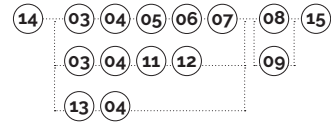
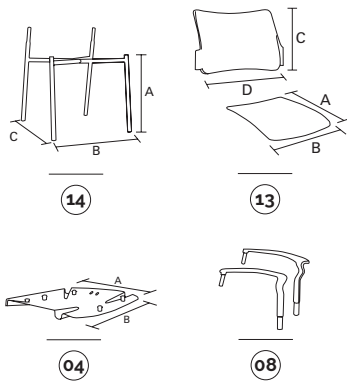

### 14 pinko-telaio quattro gambe per ruote + 4 riduttori per ruote pinko four legs frame for castors + 4 adapters for castors

code	finishing	q.kit	q.pack	a	b	c	kg.x1	vol.x1
112603-041	● nero/black	x1	80	390	530	530	3,20	mc. 0.035
112604-041	● grigio/grey	x1	80	390	530	530	3,20	mc. 0.035
112610-041	● cromato/chrome	x1	80	390	530	530	3,20	mc. 0.035

### 15 doppia ruota d.50 in desmopan con perno montato twin wheel castor d.50 desmopan with pivot mounted

code	finishing	q.kit
134403-003	● nero/black	x4

### 13 pinko-sedile/schienale in plastica colorato a vista + 2 tappi schienale + 2 tappi sedile pinko-plastic seat/back coloured at sight + 2 back caps + 2 seat caps

code	finishing	q.kit	q.pack	a	b	c	d	kg.x1	vol.x1
134015-108	● blu/blue ral 5002	x1	10	470	465	350	495	1,78	mc. 0.014
134003-108	● nero/black	x1	10	470	465	350	495	1,78	mc. 0.014
134004-109	● grigio/grey ral 7035	x1	10	470	465	350	495	1,78	mc. 0.014

### 04 pinko-sedile esterno plastica pinko-outer plastic seat

code	finishing	q.kit	q.pack	a	b	kg.x1	vol.x1
132203-026	● nero/black	x1	20	465	470	0,62	mc. 0.007

### 08 pinko-coppia braccioli dx/sx in plastica pinko-pair of plastic arms right/left

code	finishing	q.kit	q.pack	kg.x1	vol.x1
131703-050	● nero/black	x1	10	0,66	mc. 0.0037

### pinko-carrello portasedie con accessori nero pinko-trolley for chairs with accessories black

code	finishing	q.kit
110803-340	● nero/black	x1



# pinko

## 4-legs for castors/tablet accessories

main component sizes



09



**09** pinko-coppia braccioli + gancio portavoletta destro in plastica  
pinko-pair of plastic arms right/left with joint for writing tablet

code	finishing	q.kit	q.pack	kg.x1	vol.x1
131703-051	● nero/black	x1	10	0,70	mc. 0,0037

TLT  
tablet

TLT2  
tablet

TLT3  
tablet

BEAN  
tablet

TL02  
tablet

SPT2  
mechanism tablet

SPTA  
mechanism antipanic



for writing tablet options, see page 192/193

## 4-legs/seat and backrest options

main component sizes

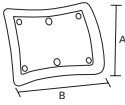

11

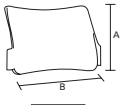

12



**11** pinko-schienale interno da tappezzare  
pinko-inner back for upholstery

code	finishing	q.kit	q.pack	a	b	kg.x1	vol.x1
132103-025	● nero/black	x1	20	350	495	0,62	mc. 0,009

**12** pinko-schienale esterno plastica + 2 tappi schienale + 2 tappi sedile  
pinko-outer plastic back + 2 back caps + 2 seat caps

code	finishing	q.kit	q.pack	a	b	kg.x1	vol.x1
132103-026	● nero/black	x1	10	350	495	0,25	mc. 0,0045

and · **03** **04**

main component sizes

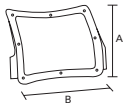

05

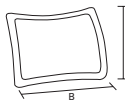

06

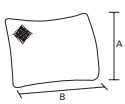

07



**05** pinko-telaio schienale in plastica per rete (portante) + 2 tappi schienale + 2 tappi sedile  
pinko-back frame in plastic for mesh + 2 back caps + 2 seat caps

code	finishing	q.kit	q.pack	a	b	kg.x1	vol.x1
132103-027	● nero/black	x2	20	345	495	0,50	mc. 0,0045

**06** pinko-cornice schienale in plastica per rete  
pinko-open frame in plastic for mesh

code	finishing	q.kit	q.pack	a	b	kg.x1	vol.x1
132103-028	● nero/black	x1	10	345	495	0,35	mc. 0,0057

**07** pinko-rete per schienale  
pinko-net for pinko back

code	finishing	q.kit	q.pack	a	b	kg.x1	vol.x1
132105-501	○ bianco/white	x1	25	460	520	0,14	mc. 0,0057
132103-501	● nero/black	x1	25	460	520	0,14	mc. 0,0057
132104-501	● grigio/grey	x1	25	460	520	0,14	mc. 0,0057

and · **03** **04**

# pinko

## slide



plastic colours

- blu/blue ral5002
- nero/black
- grigio/grey ral7035

main component sizes

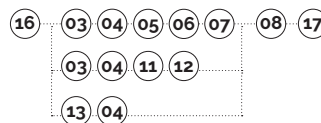
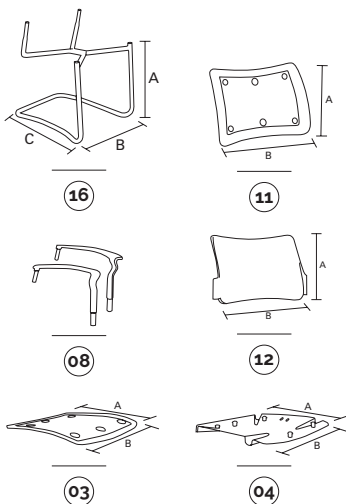

**16** pinko-base a slitta in tubo asform d.25 tappi esclusi  
pinko-slide frame pipe d.25 without caps

code	finishing	q.kit	q.pack	a	b	c	kg.x1	vol.x1
110503-093	● nero/black	x1	40	450	550	550	4,60	mc. 0,06
110504-093	● grigio/grey	x1	40	450	550	550	4,60	mc. 0,06
110510-093	● cromato/chrome	x1	40	450	550	550	4,60	mc. 0,06

**17** paracolpi testa bombata d.18  
round head cap d.18

code	finishing	q.kit
134403-101	● nero/black	x4

**03** pinko-sedile interno da tappezzare  
pinko-inner seat for upholstery

code	finishing	q.kit	q.pack	a	b	kg.x1	vol.x1
132203-025	● nero/black	x1	10	465	470	0,73	mc. 0,006

**04** pinko-sedile esterno plastica  
pinko-outer plastic seat

code	finishing	q.kit	q.pack	a	b	kg.x1	vol.x1
132203-026	● nero/black	x1	20	465	470	0,62	mc. 0,007

**11** pinko-schienale interno da tappezzare  
pinko-inner back for upholstery

code	finishing	q.kit	q.pack	a	b	kg.x1	vol.x1
132103-025	● nero/black	x1	20	350	495	0,62	mc. 0,009

**12** pinko-schienale esterno plastica + 2 tappi schienale + 2 tappi sedile  
pinko-outer plastic back + 2 back caps + 2 seat caps

code	finishing	q.kit	q.pack	a	b	kg.x1	vol.x1
132103-026	● nero/black	x1	10	350	495	0,25	mc. 0,0045

**08** pinko-coppia braccioli dx/sx in plastica  
pinko-pair of plastic arms right/left

code	finishing	q.kit	q.pack	kg.x1	vol.x1
131703-050	● nero/black	x1	10	0,66	mc. 0,0037



# pinko

## slide/seat and backrest options

main component sizes

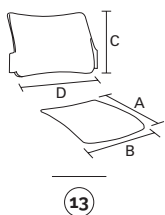

**13** pinko-sedile/schienale in plastica colorato a vista + 2 tappi schienale + 2 tappi sedile  
pinko-plastic seat/back coloured at sight + 2 back caps + 2 seat caps

code	finishing		q.kit	q.pack	a	b	c	d	kg.x1	vol.x1
134015-108	● blu/blue	ral 5002	x1	10	470	465	350	495	1,78	mc. 0.014
134003-108	● nero/black		x1	10	470	465	350	495	1,78	mc. 0.014
134004-109	● grigio/grey	ral 7035	x1	10	470	465	350	495	1,78	mc. 0.014

and **04**

main component sizes

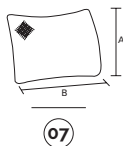
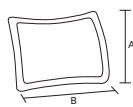
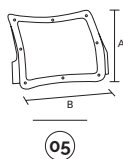

**05** pinko-telaio schienale in plastica per rete (portante) + 2 tappi schienale + 2 tappi sedile  
pinko-back frame in plastic for mesh + 2 back caps + 2 seat caps

code	finishing	q.kit	q.pack	a	b	kg.x1	vol.x1
132103-027	● nero/black	x2	20	345	495	0,50	mc. 0.0045

**06** pinko-cornice schienale in plastica per rete  
pinko-open frame in plastic for mesh

code	finishing	q.kit	q.pack	a	b	kg.x1	vol.x1
132103-028	● nero/black	x1	10	345	495	0,35	mc. 0.0057

**07** pinko-rete per schienale  
pinko-net for pinko back

code	finishing	q.kit	q.pack	a	b	kg.x1	vol.x1
132105-501	○ bianco/white	x1	25	460	520	0,14	mc. 0.0057
132103-501	● nero/black	x1	25	460	520	0,14	mc. 0.0057
132104-501	● grigio/grey	x1	25	460	520	0,14	mc. 0.0057

and **03** **04**

# pinko

## swivel



plastic colours

- blu/blue ral5002
- nero/black
- grigio/grey ral7035

main component sizes

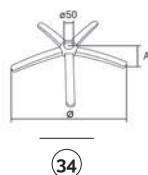
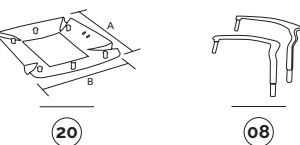
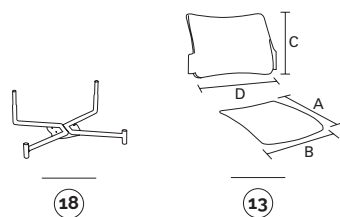

optionals

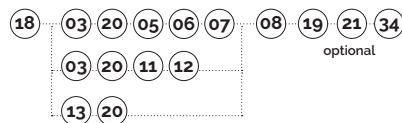
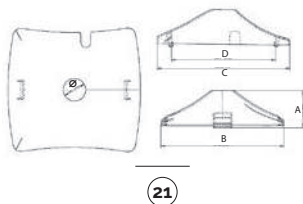

**18** pinko-telaio per girevole comando a gas senza tappi  
pinko-swivel frame with gas lever without caps

code	finishing	q.kit	q.pack	kg.x1	vol.x1
112603-045	● nero/black	x1	80	2,60	mc. 0,005
112604-045	● grigio/grey	x1	80	2,60	mc. 0,005

**19** tappo copritesta alettato d.25 nero  
cover head d.25 black

code	finishing	q.kit
134103-250	● nero/black	x2

**13** pinko-sedile/schienale in plastica colorato a vista + 2 tappi schienale + 2 tappi sedile  
pinko-plastic seat/back coloured at sight + 2 back caps + 2 seat caps

code	finishing	q.kit	q.pack	a	b	c	d	kg.x1	vol.x1
134015-108	● blu/blue ral 5002	x1	10	470	465	350	495	1,78	mc. 0,014
134003-108	● nero/black	x1	10	470	465	350	495	1,78	mc. 0,014
134004-109	● grigio/grey ral 7035	x1	10	470	465	350	495	1,78	mc. 0,014

**20** pinko-sedile esterno plastica per girevole e panca  
pinko-plastic outer seat for swivel and bench

code	finishing	q.kit	q.pack	a	b	kg.x1	vol.x1
132203-027	● nero/black	x1	20	465	470	0,60	mc. 0,007

**08** pinko-coppia braccioli dx/sx in plastica  
pinko-pair of plastic arms right/left

code	finishing	q.kit	q.pack	kg.x1	vol.x1
131703-050	● nero/black	x1	10	0,66	mc. 0,0037

**21** cpg-copertina in plastica per telaio girevole  
cpg-plastic cover for swivel frame

code	finishing	q.kit	q.pack	a	b	c	d	ø	kg.x1	vol.x1
130903-000	● nero/black	x1	50	60	200	210	167	36	0,1	mc. 0,0015

**34** b40 base in metallo d.640 con coprisaldatura  
b40 metal base d.640 with cover welding

code	finishing	q.kit	q.pack	a	ø	kg.x1	vol.x1
110210-027	● cromato/chrome	x1	5	60	640	2,85	mc. 0,014

CPG  
plastic cover for swivel frame



# pinko

## swivel/seat and backrest options

main component sizes

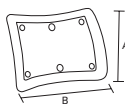

11

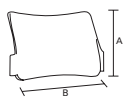

12



### 11 pinko-schienale interno da tappezzare pinko-inner back for upholstery

code	finishing	q.kit	q.pack	a	b	kg.x1	vol.x1
132103-025	● nero/black	x1	20	350	495	0,62	mc. 0.009

### 12 pinko-schienale esterno plastica + 2 tappi schienale + 2 tappi sedile pinko-outer plastic back + 2 back caps + 2 seat caps

code	finishing	q.kit	q.pack	a	b	kg.x1	vol.x1
132103-026	● nero/black	x1	10	350	495	0,25	mc. 0.0045

and .. 03 20

main component sizes

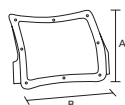

05

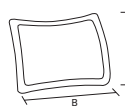

06

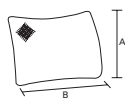

07



### 05 pinko-telaio schienale in plastica per rete (portante) + 2 tappi schienale + 2 tappi sedile pinko-back frame in plastic for mesh + 2 back caps + 2 seat caps

code	finishing	q.kit	q.pack	a	b	kg.x1	vol.x1
132103-027	● nero/black	x2	20	345	495	0,50	mc. 0.0045

### 06 pinko-cornice schienale in plastica per rete pinko-open frame in plastic for mesh

code	finishing	q.kit	q.pack	a	b	kg.x1	vol.x1
132103-028	● nero/black	x1	10	345	495	0,35	mc. 0.0057

### 07 pinko-rete per schienale pinko-net for pinko back

code	finishing	q.kit	q.pack	a	b	kg.x1	vol.x1
132105-501	○ bianco/white	x1	25	460	520	0,14	mc. 0.0057
132103-501	● nero/black	x1	25	460	520	0,14	mc. 0.0057
132104-501	● grigio/grey	x1	25	460	520	0,14	mc. 0.0057

and .. 03 20

# pinko

## bench



plastic colours

- blu/blue ral5002
- nero/black
- grigio/grey ral7035

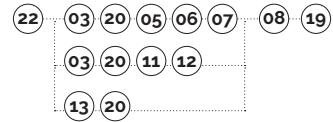

main component sizes

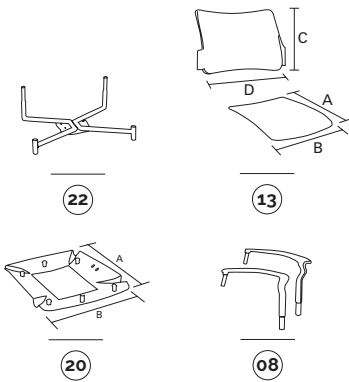

**22** pinko-telaio per panca senza tappi  
pinko-bench frame caps excluded

code	finishing	q.kit	q.pack	kg.x1	vol.x1
110703-072	● nero/black	x1	80	2,50	mc. 0.005
110704-072	● grigio/grey	x1	80	2,50	mc. 0.005

**19** tappo copritesta alettato d.25 nero  
cover head d.25 black

code	finishing	q.kit
134103-250	● nero/black	x2

**13** pinko-sedile/schienale in plastica colorato a vista + 2 tappi schienale + 2 tappi sedile  
pinko-plastic seat/back coloured at sight + 2 back caps + 2 seat caps

code	finishing	q.kit	q.pack	a	b	c	d	kg.x1	vol.x1
134015-108	● blu/blue ral 5002	x1	10	470	465	350	495	1,78	mc. 0.014
134003-108	● nero/black	x1	10	470	465	350	495	1,78	mc. 0.014
134004-109	● grigio/grey ral 7035	x1	10	470	465	350	495	1,78	mc. 0.014

**20** pinko-sedile esterno plastica per girevole e panca  
pinko-plastic outer seat for swivel and bench

code	finishing	q.kit	q.pack	a	b	kg.x1	vol.x1
132203-027	● nero/black	x1	20	465	470	0,60	mc. 0.007

**08** pinko-coppia braccioli dx/sx in plastica  
pinko-pair of plastic arms right/left

code	finishing	q.kit	q.pack	kg.x1	vol.x1
131703-050	● nero/black	x1	10	0,66	mc. 0.0037

for the bench components, see page 201

optionals

OPTIONAL  
bench  
connector



E-USB **NEW**  
bench plug



JIM **NEW**  
bench leg



APOLL  
bench arm



plastic

90GM  
bench leg



90GF  
bench leg



100GM  
bench leg



200GM  
bench leg



PIONEER  
bench arm



metal

CUT  
bench leg



SLIM  
bench leg



CUT  
bench arm



SLIM  
bench arm



aluminium

# pinko

## bench/seat and backrest options

main component sizes

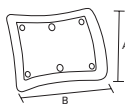

11

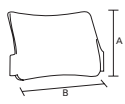

12



**11** pinko-schienale interno da tappezzare  
pinko-inner back for upholstery

code	finishing	q.kit	q.pack	a	b	kg.x1	vol.x1
132103-025	● nero/black	x1	20	350	495	0,62	mc. 0.009

**12** pinko-schienale esterno plastica + 2 tappi schienale + 2 tappi sedile  
pinko-outer plastic back + 2 back caps + 2 seat caps

code	finishing	q.kit	q.pack	a	b	kg.x1	vol.x1
132103-026	● nero/black	x1	10	350	495	0,25	mc. 0.0045

and **03** **20**

main component sizes

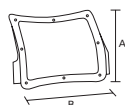

05

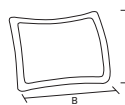

06

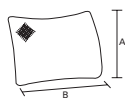

07



**05** pinko-telaio schienale in plastica per rete (portante) + 2 tappi schienale + 2 tappi sedile  
pinko-back frame in plastic for mesh + 2 back caps + 2 seat caps

code	finishing	q.kit	q.pack	a	b	kg.x1	vol.x1
132103-027	● nero/black	x2	20	345	495	0,50	mc. 0.0045

**06** pinko-cornice schienale in plastica per rete  
pinko-open frame in plastic for mesh

code	finishing	q.kit	q.pack	a	b	kg.x1	vol.x1
132103-028	● nero/black	x1	10	345	495	0,35	mc. 0.0057

**07** pinko-rete per schienale  
pinko-net for pinko back

code	finishing	q.kit	q.pack	a	b	kg.x1	vol.x1
132105-501	○ bianco/white	x1	25	460	520	0,14	mc. 0.0057
132103-501	● nero/black	x1	25	460	520	0,14	mc. 0.0057
132104-501	● grigio/grey	x1	25	460	520	0,14	mc. 0.0057

and **03** **20**

# pinko

## folding bench

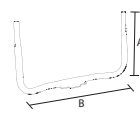
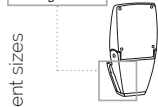
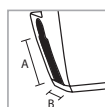
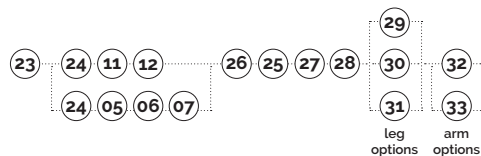

main component sizes

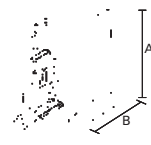
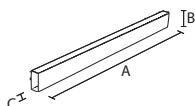
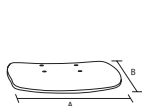

### 23 siton-meccanismo panca ribaltabile alluminio lucido siton-polished aluminium mechanism for folding bench

code	finishing	q.kit	q.pack	a	b	kg.x1	vol.x1
110704-180	● alluminio/aluminium	x1	4	80	40	2,81	mc. 0,007

### 24 pinko-telaio schienale a U per panca ribaltabile pinko-frame back bench for folding

code	finishing	q.kit	q.pack	a	b	kg.x1	vol.x1
110703-071	● nero/black	x1	15	300	490	1,40	mc. 0,003
110704-182	● grigio/grey	x1	15	300	490	1,40	mc. 0,003

### 25 siton-sedile panca ribaltabile in legno per tappezzare siton-bench seat folding wooden for upholstery

code	finishing	q.kit	q.pack	a	b	kg.x1	vol.x1
122207-003	● grezzo/raw	x1	10	420	410	1,30	mc. 0,007

### 26 vite tcei m5x16 brunita nera (vite per fissaggio telaio schienale in tubo) screw m5x16 cylindrical head hexagon embedded burnishing black (screw for tube back frame fixing)

code	finishing	q.kit
117703-160	● nero/black	x4

### 27 vite tcei m6x20 zincata (vite per fissaggio sedile) screw m6x20 cylindrical head hexagon embedded burnishing zinc (screw for seat fixing)

code	finishing	q.kit
117711-198	● zincata/zinc	x4

### 28 90T(03) trave per panca 80x40 90T(03) beam for bench 80x40

code	finishing		q.kit	q.pack	a	b	c	kg.x1	vol.x1
110703-190	● nero/black	2 posti / 2 seats	x1	1	1160	80	40	3,20	mc. 0,0045
110704-190	● grigio/grey	2 posti / 2 seats	x1	1	1160	80	40	3,20	mc. 0,0045
110703-191	● nero/black	3 posti / 3 seats	x1	1	1710	80	40	4,71	mc. 0,005
110704-191	● grigio/grey	3 posti / 3 seats	x1	1	1710	80	40	4,71	mc. 0,005
110703-192	● nero/black	4 posti / 4 seats	x1	1	2260	80	40	6,22	mc. 0,0085
110704-192	● grigio/grey	4 posti / 4 seats	x1	1	2260	80	40	6,22	mc. 0,0085
110703-193	● nero/black	5 posti / 5 seats	x1	1	2800	80	40	7,72	mc. 0,001
110704-193	● grigio/grey	5 posti / 5 seats	x1	1	2800	80	40	7,72	mc. 0,001

### 29 90GF(02)-gamba fissa per panca con accessori 90GF(02)-fixed leg for bench with accessories

code	finishing	q.kit	q.pack	a	b	kg.x1	vol.x1
110703-122	● nero/black	x2	2	320	310	1,80	mc. 0,0012
110704-107	● grigio/grey	x2	2	320	310	1,80	mc. 0,0012

for the components below, see page 43

for the bench components, see page 201



# pinko

## folding bench/tablet accessories



for writing tablet options, see page 192/193

## folding bench/seat and backrest option

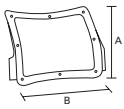

05

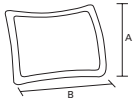

06

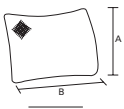

07



- 05 pinko-telaio schienale in plastica per rete (portante) + 2 tappi schienale + 2 tappi sedile  
pinko-back frame in plastic for mesh + 2 back caps + 2 seat caps

code	finishing	q.kit	q.pack	a	b	kg.x1	vol.x1
132103-027	● nero/black	x2	20	345	495	0,50	mc. 0.0045

- 06 pinko-cornice schienale in plastica per rete  
pinko-open frame in plastic for mesh

code	finishing	q.kit	q.pack	a	b	kg.x1	vol.x1
132103-028	● nero/black	x1	10	345	495	0,35	mc. 0.0057

- 07 pinko-rete per schienale  
pinko-net for pinko back

code	finishing	q.kit	q.pack	a	b	kg.x1	vol.x1
132105-501	○ bianco/white	x1	25	460	520	0,14	mc. 0.0057
132103-501	● nero/black	x1	25	460	520	0,14	mc. 0.0057
132104-501	● grigio/grey	x1	25	460	520	0,14	mc. 0.0057

and 24 26 25 27

## folding bench/leg and armrest options

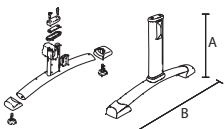

05



- 30 90gm(02)-gamba mobile per panca con accessori  
90gm(02)-movable leg for bench with accessories

code	finishing	q.kit	q.pack	a	b	kg.x1	vol.x1
110703-120	● nero/black	x2	2	320	600	2,70	mc. 0.0012
110704-099	● grigio/grey	x2	2	320	600	2,70	mc. 0.0012
110710-007	● cromato/chrome	x2	2	320	600	2,70	mc. 0.0012

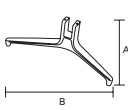

05



- 31 siton(ga02)-gamba lunga in alluminio per panca  
siton(ga02)-long leg aluminium for bench

code	finishing	q.kit	q.pack	a	b	kg.x1	vol.x1
110704-171	● alluminio/aluminium	x2	5	305	643	2,80	mc. 0.014

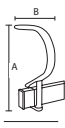

05



- 32 siton-bracciolo ellittico per panca con accessori  
siton-elliptical arm for bench with accessories

code	finishing	q.kit	q.pack	a	b	kg.x1	vol.x1
111710-020	● cromato/chrome	x1	5	370	340	1,70	mc. 0.015
111703-019	● nero/black	x1	5	370	340	1,70	mc. 0.015

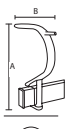

05



- 33 siton.p-bracciolo ellittico per panca con gancio porta tavoletta con accessori  
siton.p-elliptical arm for bench with table hook with accessories

code	finishing	q.kit	q.pack	a	b	kg.x1	vol.x1
111710-017	● cromato/chrome	x1	5	370	340	1,70	mc. 0.015
111703-017	● nero/black	x1	5	370	340	1,70	mc. 0.015

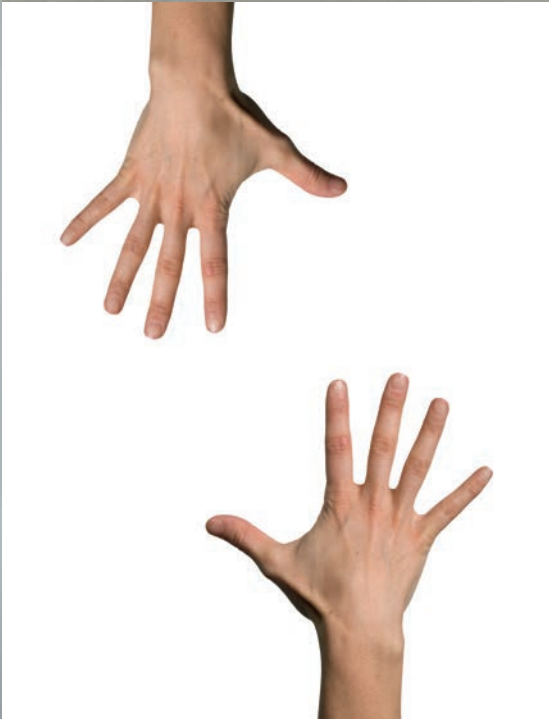
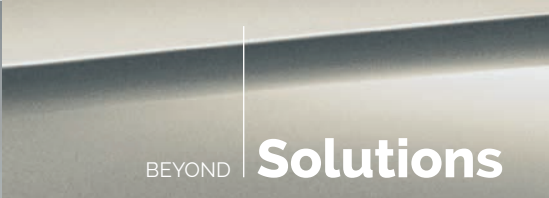



**aba**



# aba



\*left arm for writing tablet available

slide  
slide w/armrests  
slide w/writing tablet  
stool

4 legs  
4 legs w/armrest  
4 legs w/writing tablet

swivel  
swivel w/armrest

bench

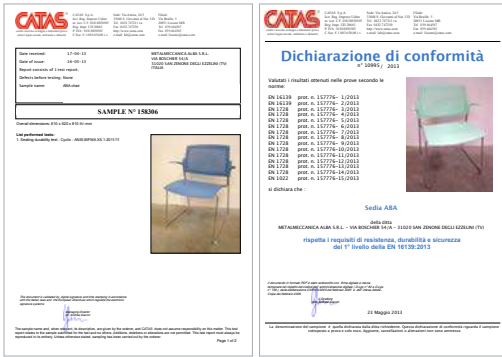

BIFMA TEST

EN 16139



tools



certification



brochure



video

aba showing

features



designed by:  
r&d albacomponents



trolley  
available



Sedia robusta, caratterizzata da una **perfetta impilabilità e da una intercambiabilità inconfondibili**.

Ogni singolo componente in plastica, può essere assemblato con tutti i telai disponibili in gamma, combinando con grande semplicità le diverse versioni della stessa seduta.

**Certificata CATAS e BIFMA.**

*A sturdy chair, characterized by a **perfect stacking and high interchangeability**.*

*Each of the individual plastic components can be assembled with all the frames available in the range, enabling many different versions of the same seat to be created with ease.*

**CATAS and BIFMA certified**



# aba

slide w/writing tablet



plastic colours

- rosso/red 527
- nero/black
- grigio/gray 7035
- bianco/white 218
- viola/violet 145
- blu/blue 5023
- verde/pastel green 6019

aba-carrello portasedie con accessori  
aba-trolley for chairs with accessories

code	finishing
110803-372	● nero/black

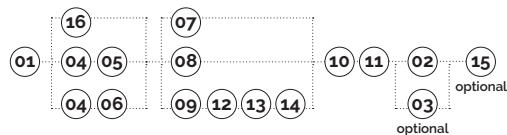

main component sizes

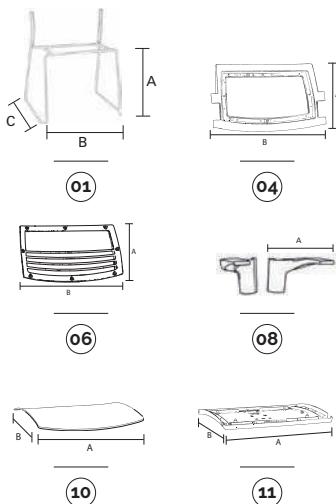

optionals



**01** aba-telaio a slitta in tondino d.12  
aba-slide frame wire d.12

code	finishing	q.kit	q.pack	a	b	c	kg.x1	vol.x1
111810-036	● cromato/chrome	x1	60	440	570	485	4,70	mc. 0.035

**02** confezione di basi a pinza antirrotazione per tondino colore neutro  
neutral clips base for wire d.11 package

code	finishing	q.kit	q.pack
137006-070	○ neutro/neutral	x4	200

**03** base piana a pinza doppia  
double flat clip base

code	finishing	q.kit
134006-021	○ neutro/neutral	x4

**04** aba-telaio schienale esterno portante in plastica  
aba-outer plastic back

code	finishing	q.kit	q.pack	a	b	kg.x1	vol.x1
132103-065	● nero/black	x1	20	320	460	0,51	mc. 0.005

**06** aba-cornice schienale in plastica per rete  
aba-frame back in plastic mesh

code	finishing	q.kit	q.pack	a	b	kg.x1	vol.x1
132103-063	● nero/black	x1	25	250	420	0,25	mc. 0.0025

**08** aba-coppia braccioli destro-sinistro plastica  
aba-pair arm right-left plastic

code	finishing	q.kit	q.pack	a
131703-055	● nero/black	x1	20	190

**10** aba-sedile plastica colorato a vista (tappezzabile)  
aba-plastic seat colored (to be upholstered)

code	finishing	q.kit	q.pack	a	b	kg.x1	vol.x1
132203-070	● nero/black	x1	10	455	470	1,32	mc. 0.01

**11** aba-sottosedile plastica colorato a vista+viti  
aba-outer plastic seat colored+screws

code	finishing	q.kit	q.pack	a	b	kg.x1	vol.x1
132203-071	● nero/black	x1	20	430	410	0,54	mc. 0.005

**15** aba-aggancio laterale maschio+femmina in plastica  
aba-plastic linking device male+female

code	finishing	q.kit
134003-137	● nero/black	x1



for all colour codes, see page 59



# aba

## slide/tablet accessories

main component sizes

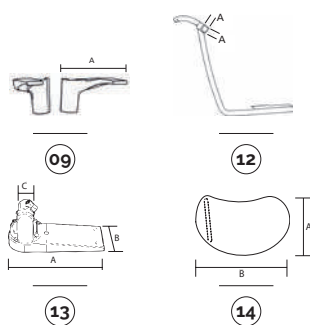

- 09** aba-coppia braccioli destro-sinistro plastica per tavoletta  
aba-pair arm right-left plastic for tablet

code	finishing	q.kit	q.pack	a
131703-056	● nero/black	x1	20	190

- 12** aba-telaio in ferro per aggancio tavoletta+viti  
aba-metal frame with table hook + screws

code	finishing	q.kit	q.pack	kg.x1	vol.x1
111703-054	● nero/black destro/right - slitta/slide	x1	10	15x15	0,60 mc. 0.002
111703-055	● nero/black sinistro/left - slitta/slide	x1	10	15x15	0,60 mc. 0.002

- 13** spt2-snodo per tavoletta in plastica  
spt2-mechanism for writing tablet in plastic

code	finishing	q.kit	q.pack	a	b	c	kg.x1	vol.x1
134003-039	● nero/black	x1	20	180	66	15x15	0,35	mc. 0.0006

- 14** bean-tavoletta in plastica spessore 16  
bean-writing tablet in plastic thickness 16 mm

code	finishing	q.kit	q.pack	a	b	kg.x1	vol.x1
134003-044	● nero/black	x1	20	235	370	0,40	mc. 0.002



for writing tablet options, see page 192/193

## slide/backrest options

main component sizes

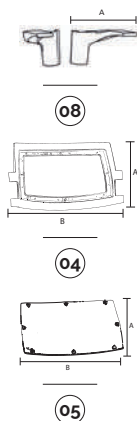

- 08** aba-coppia braccioli destro-sinistro plastica  
aba-pair arm right-left plastic

code	finishing	q.kit	q.pack	a
131703-055	● nero/black	x1	20	190

- 04** aba-telaio schienale esterno portante in plastica  
aba-outer plastic back

code	finishing	q.kit	q.pack	a	b	kg.x1	vol.x1
132103-065	● nero/black	x1	20	320	460	0,51	mc. 0.0005

- 05** aba-pannello schienale in plastica da tappezzare  
aba-frame back in plastic for upholstery

code	finishing	q.kit	q.pack	a	b	kg.x1	vol.x1
132103-064	● nero/black	x1	25	250	420	0,37	mc. 0.0025

CERTIFIED BY  
**BIFMA**  
**CATAS**

- 08** aba-coppia braccioli destro-sinistro plastica  
aba-pair arm right-left plastic

code	finishing	q.kit	q.pack	a
131702-055	● rosso/red 527	x1	20	190

- 16** aba-schienale plastica colorato a vista  
aba-plastic back colored

code	finishing	q.kit	q.pack	a	b	kg.x1	vol.x1
132102-067	● rosso/red 527	x1	20	320	460	0,63	mc. 0.009

main component sizes



- 07** aba-coppia inserti schienale destro-sinistro plastica  
aba-back inserts right-left plastic

code	finishing	q.kit	q.pack
132115-066	● blu/blue 5023	x1	50

- 16** aba-schienale plastica colorato a vista  
aba-plastic back colored

code	finishing	q.kit	q.pack	a	b	kg.x1	vol.x1
132115-067	● blu/blue 5023	x1	20	320	460	0,63	mc. 0.009

main component sizes



# aba

## stool

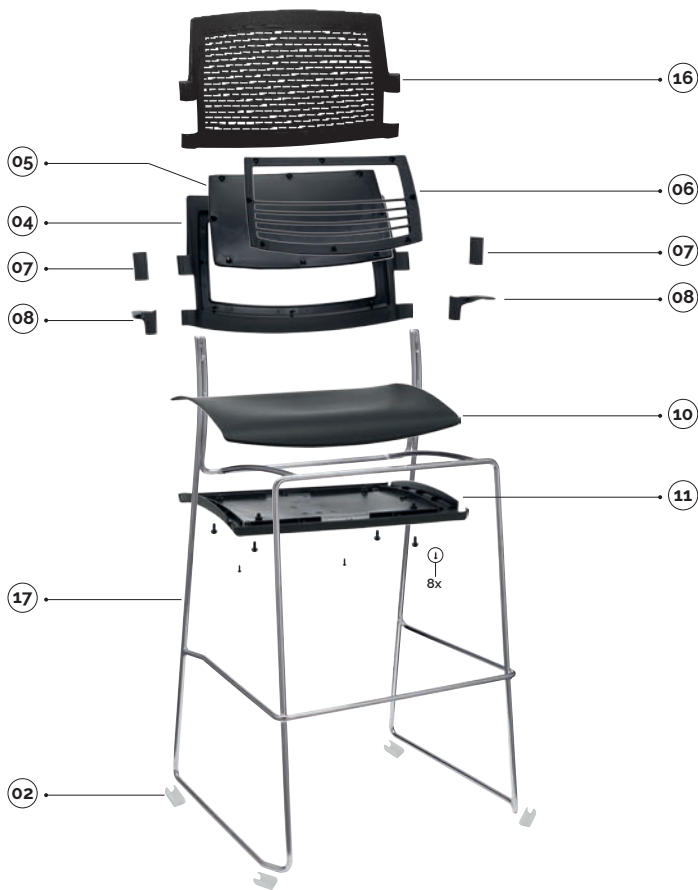

plastic colours

- rosso/red 527
- nero/black
- grigio/gray 7035
- bianco/white 218
- viola/violet 145
- blu/blue 5023
- verde/pastel green 6019

main component sizes

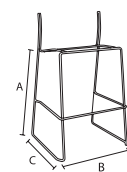

17



16



07

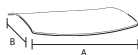

10



11



02



03

optional

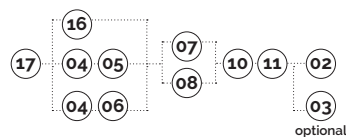

### 17 aba-sgabello alto in tondino cromato senza tappi aba-wire high bar stool without caps

code	finishing	q.kit	q.pack	a	b	c	kg.x1	vol.x1
111810-037	● cromato/chrome	x1	40	685	500	510	4,70	mc. 0.063

### 02 confezione di basi a pinza antirrotazione per tondino colore neutro neutral clips base for wire d.11 package

code	finishing	q.kit	q.pack
137006-070	○ neutro/neutral	x4	200

### 03 base piana a pinza doppia double flat clip base

code	finishing	q.kit
134006-021	○ neutro/neutral	x4

### 16 aba-schienale plastica colorato a vista aba-plastic back colored

code	finishing	q.kit	q.pack	a	b	kg.x1	vol.x1
132105-067	○ bianco/white 218	x1	20	320	460	0,63	mc. 0.009

### 07 aba-coppia inserti schienale destro-sinistro plastica aba-pair back inserts right-left plastic

code	finishing	q.kit	q.pack
132105-066	○ bianco/white 218	x1	50

### 10 aba-sedile plastica colorato a vista (tappizzabile) aba-plastic seat colored (to be upholstered)

code	finishing	q.kit	q.pack	a	b	kg.x1	vol.x1
132205-070	○ bianco/white 218	x1	10	455	470	1,32	mc. 0.01

### 11 aba-sottosedile plastica colorato a vista+viti aba-outer plastic seat colored+screws

code	finishing	q.kit	q.pack	a	b	kg.x1	vol.x1
132205-071	○ bianco/white 218	x1	20	430	410	0,54	mc. 0.005



for all colour codes, see page 59

# aba

## stool/backrest options

main component sizes



08

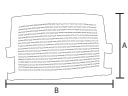

16



**08** aba-coppia braccioli destro-sinistro plastica  
aba-pair arm right-left plastic

code	finishing		q.kit	q.pack	a
131702-055	● rosso/red	527	x1	20	190

**16** aba-schienale plastica colorato a vista  
aba-plastic back colored

code	finishing		q.kit	q.pack	a	b	kg.x1	vol.x1
132102-067	● rosso/red	527	x1	20	320	460	0,63	mc. 0,009

main component sizes



07

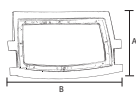

04



05



**07** aba-coppia inserti schienale destro-sinistro plastica  
aba-pair back inserts right-left plastic

code	finishing		q.kit	q.pack
132103-066	● nero/black		x1	50

**04** aba-telaio schienale esterno portante in plastica  
aba-outer plastic back

code	finishing		q.kit	q.pack	a	b	kg.x1	vol.x1
132103-065	● nero/black		x1	20	320	460	0,51	mc. 0,005

**05** aba-pannello schienale in plastica da tappezzare  
aba-frame back in plastic for upholstery

code	finishing		q.kit	q.pack	a	b	kg.x1	vol.x1
132103-064	● nero/black		x1	25	250	420	0,37	mc. 0,0025

main component sizes



07

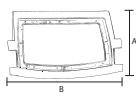

04

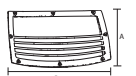

06



**07** aba-coppia inserti schienale destro-sinistro plastica  
aba-pair back inserts right-left plastic

code	finishing		q.kit	q.pack
132103-066	● nero/black		x1	50

**04** aba-telaio schienale esterno portante in plastica  
aba-outer plastic back

code	finishing		q.kit	q.pack	a	b	kg.x1	vol.x1
132103-065	● nero/black		x1	20	320	460	0,51	mc. 0,005

**06** aba-cornice schienale in plastica per rete  
aba-frame back in plastic mesh

code	finishing		q.kit	q.pack	a	b	kg.x1	vol.x1
132103-063	● nero/black		x1	25	250	420	0,25	mc. 0,0025

# aba

4-legs w/writing tablet



plastic colours

- rosso/red 527
- nero/black
- grigio/gray 7035
- bianco/white 218
- viola/violet 145
- blu/blue 5023
- verde/pastel green 6019

aba-carrello portasedie con accessori  
aba-trolley for chairs with accessories

code	finishing
110803-372	● nero/black

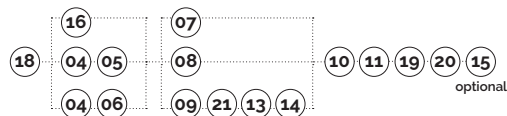

main component sizes

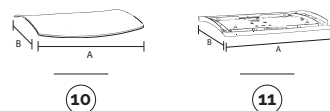
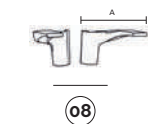
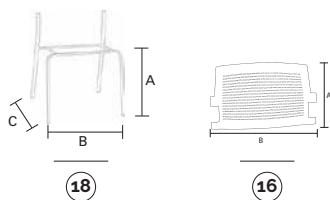

optionals



code	finishing	q.kit	q.pack	a	b	c	kg.x1	vol.x1
111803-035	● nero/black	x1	80	440	530	510	3,70	mc. 0.035
111804-035	● grigio/grey	x1	80	440	530	510	3,70	mc. 0.035
111810-035	● cromato/chrome	x1	80	440	530	510	3,70	mc. 0.035
<b>19</b> puntale alettato ovale 25x12 posteriore inclinato oval inclined ribbed insert 25x12 posterior								
code	finishing	q.kit						
134203-014	● nero/black	x2						
<b>20</b> puntale alettato ovale 25x12 anteriore inclinato oval inclined ribbed insert 25x12 anterior								
code	finishing	q.kit						
134203-015	● nero/black	x2						
<b>16</b> aba-schienale plastica colorato a vista aba-plastic back colored								
code	finishing	q.kit	q.pack	a	b		kg.x1	vol.x1
132103-067	● nero/black	x1	20	320	460		0,63	mc. 0.009
<b>08</b> aba-coppia braccioli destro-sinistro plastica aba-pair arm right-left plastic								
code	finishing	q.kit	q.pack	a				
131703-055	● nero/black	x1	20	190				
<b>10</b> aba-sedile plastica colorato a vista (tappezzabile) aba-plastic seat colored (to be upholstered)								
code	finishing	q.kit	q.pack	a	b		kg.x1	vol.x1
132203-070	● nero/black	x1	10	455	470		1,32	mc. 0.01
<b>11</b> aba-sottosedile plastica colorato a vista+viti aba-outer plastic seat colored+screws								
code	finishing	q.kit	q.pack	a	b		kg.x1	vol.x1
132203-071	● nero/black	x1	20	430	410		0,54	mc. 0.005
<b>15</b> aba-aggancio laterale maschio+femmina in plastica aba-plastic linking device male+female								
code	finishing	q.kit						
134003-137	● nero/black	x1						



for all colour codes, see page 59

# aba

## 4-legs/tablet accessories

main component sizes

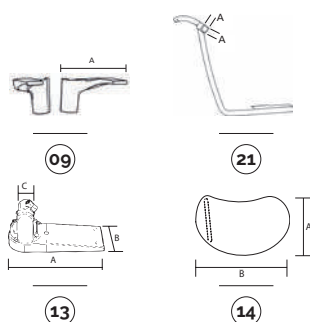

**09** aba-coppia braccioli destro-sinistro plastica per tavoletta  
aba-pair arm right-left plastic for tablet

code	finishing	q.kit	q.pack	a
131703-056	● nero/black	x1	20	190

**21** aba-telaio in ferro per aggancio tavoletta+viti  
aba-metal frame whit table hook + screws

code	finishing	q.kit	q.pack	kg.x1	vol.x1
111703-050	● nero/black destro/right - 4 gambe/4-legs	x1	10	15x15	0,60 mc. 0.002
111703-053	● nero/black sinistro/left - 4 gambe/4-legs	x1	10	15x15	0,60 mc. 0.002

**13** spt2-snodo per tavoletta in plastica  
spt2-mechanism for writing tablet in plastic

code	finishing	q.kit	q.pack	a	b	c	kg.x1	vol.x1
134003-039	● nero/black	x1	20	180	66	15x15	0,35	mc. 0.0006

**14** bean-tavoletta in plastica spessore 16  
bean-writing tablet in plastic thickness 16 mm

code	finishing	q.kit	q.pack	a	b	kg.x1	vol.x1
134003-044	● nero/black	x1	20	235	370	0,40	mc. 0.002



for writing tablet options, see page 192/193

## 4-legs/backrest options

main component sizes

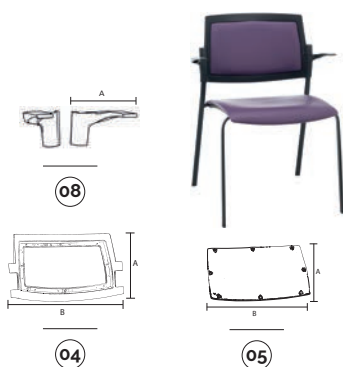

**08** aba-coppia braccioli destro-sinistro plastica  
aba-pair arm right-left plastic

code	finishing	q.kit	q.pack	a
131703-055	● nero/black	x1	20	190

**04** aba-telaio schienale esterno portante in plastica  
aba-outer plastic back

code	finishing	q.kit	q.pack	a	b	kg.x1	vol.x1
132103-065	● nero/black	x1	20	320	460	0,51	mc. 0.005

**05** aba-pannello schienale in plastica da tappezzare  
aba-frame back in plastic for upholstery

code	finishing	q.kit	q.pack	a	b	kg.x1	vol.x1
132103-064	● nero/black	x1	25	250	420	0,37	mc. 0.0025

main component sizes

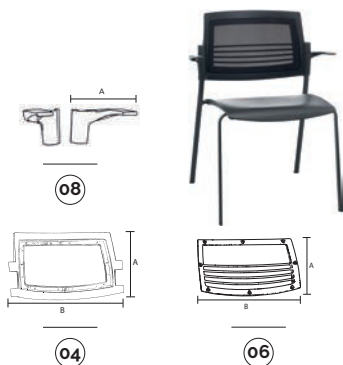

**08** aba-coppia braccioli destro-sinistro plastica  
aba-pair arm right-left plastic

code	finishing	q.kit	q.pack	a
131703-055	● nero/black	x1	20	190

**04** aba-telaio schienale esterno portante in plastica  
aba-outer plastic back

code	finishing	q.kit	q.pack	a	b	kg.x1	vol.x1
132103-065	● nero/black	x1	20	320	460	0,51	mc. 0.005

**06** aba-cornice schienale in plastica per rete  
aba-frame back in plastic mesh

code	finishing	q.kit	q.pack	a	b	kg.x1	vol.x1
132103-063	● nero/black	x1	25	250	420	0,25	mc. 0.0025

main component sizes

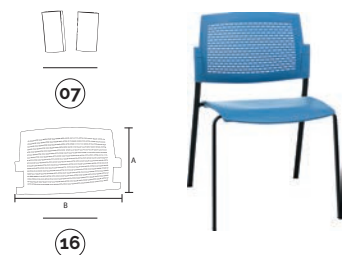

**07** aba-coppia inserti schienale destro-sinistro plastica  
aba-pair back inserts right-left plastic

code	finishing	q.kit	q.pack
132115-066	● blu/blue	x1	50

**16** aba-schienale plastica colorato a vista  
aba-plastic back colored

code	finishing	q.kit	q.pack	a	b	kg.x1	vol.x1
132115-067	● blu/blue	x1	20	320	460	0,63	mc. 0.009

# aba

## swivel



plastic colours

- rosso/red 527
- nero/black
- grigio/gray 7035
- bianco/white 218
- viola/violet 145
- blu/blue 5023
- verde/pastel green 6019

main component sizes

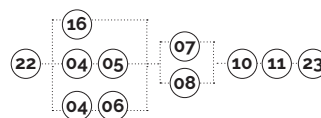
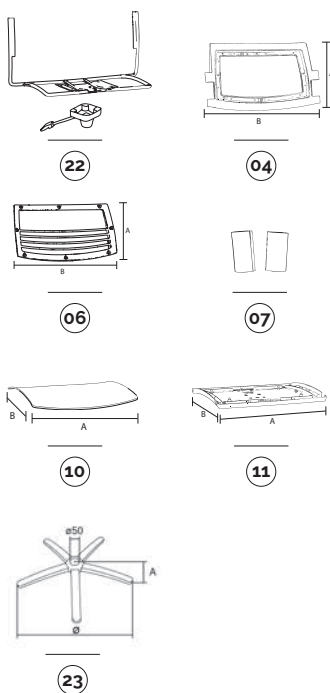

### 22 aba-telaio girevole gas c/blocchetto aba-swivel frame gas with lever

code	finishing	q.kit	q.pack	kg.x1	vol.x1
111803-036	● nero/black	x1	100	3,22	mc. 0.02

### 04 aba-telaio schienale esterno portante in plastica aba-outer plastic back

code	finishing	q.kit	q.pack	a	b	kg.x1	vol.x1
132103-065	● nero/black	x1	20	320	460	0,51	mc. 0.005

### 06 aba-cornice schienale in plastica per rete aba-frame back in plastic mesh

code	finishing	q.kit	q.pack	a	b	kg.x1	vol.x1
132103-063	● nero/black	x1	25	250	420	0,25	mc. 0.0025

### 07 aba-coppia inserti schienale destro-sinistro plastica aba-pair back inserts right-left plastic

code	finishing	q.kit	q.pack
132103-066	● nero/black	x1	50

### 10 aba-sedile plastica colorato a vista (tappezzabile) aba-plastic seat colored (to be upholstered)

code	finishing	q.kit	q.pack	a	b	kg.x1	vol.x1
132203-070	● nero/black	x1	10	455	470	1,32	mc. 0.01

### 11 aba-sottosedile plastica colorato a vista+viti aba-outer plastic seat colored+screws

code	finishing	q.kit	q.pack	a	b	kg.x1	vol.x1
132203-071	● nero/black	x1	20	430	410	0,54	mc. 0.005

### 23 b40 base in metallo d.640 con coprisaldatura b40 metal base d.640 with cover welding

code	finishing	q.kit	q.pack	a	ø	kg.x1	vol.x1
110210-027	● cromato/chrome	x1	5	60	640	2,85	mc. 0.014



for all colour codes, see page 59



# aba

## swivel/backrest options

main component sizes



08

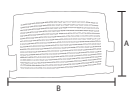

16



**08** aba-coppia braccioli destro-sinistro plastica  
aba-pair arm right-left plastic

code	finishing		q.kit	q.pack	a
131702-055	● rosso/red	527	x1	20	190

**16** aba-schienale plastica colorato a vista  
aba-plastic back colored

code	finishing		q.kit	q.pack	a	b	kg.x1	vol.x1
132102-067	● rosso/red	527	x1	20	320	460	0,63	mc. 0,009

main component sizes



08

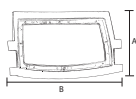

04

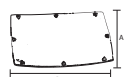

05



**08** aba-coppia braccioli destro-sinistro plastica  
aba-pair arm right-left plastic

code	finishing		q.kit	q.pack	a
131703-055	● nero/black		x1	20	190

**04** aba-telaio schienale esterno portante in plastica  
aba-outer plastic back

code	finishing		q.kit	q.pack	a	b	kg.x1	vol.x1
132103-065	● nero/black		x1	20	320	460	0,51	mc. 0,005

**05** aba-pannello schienale in plastica da tappezzare  
aba-frame back in plastic for upholstery

code	finishing		q.kit	q.pack	a	b	kg.x1	vol.x1
132103-064	● nero/black		x1	25	250	420	0,37	mc. 0,0025

main component sizes



07

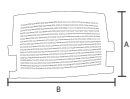

16



**07** aba-coppia inserti schienale destro-sinistro plastica  
aba-pair back inserts right-left plastic

code	finishing		q.kit	q.pack
132115-066	● blu/blue	5023	x1	50

**16** aba-schienale plastica colorato a vista  
aba-plastic back colored

code	finishing		q.kit	q.pack	a	b	kg.x1	vol.x1
132115-067	● blu/blue	5023	x1	20	320	460	0,63	mc. 0,009

# aba

## bench



plastic colours

- rosso/red 527
- nero/black
- grigio/gray 7035
- bianco/white 218
- viola/violet 145
- blu/blue 5023
- verde/pastel green 6019

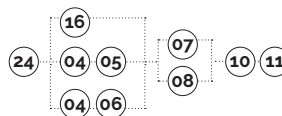

main component sizes

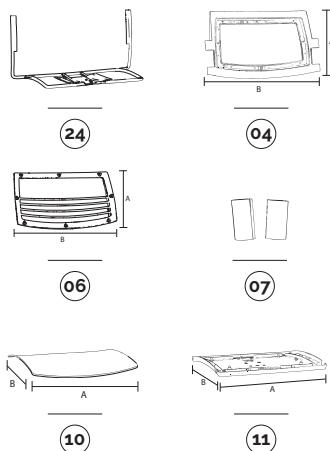

### 24 aba-telaio per panca aba-bench frame

code	finishing	q.kit	q.pack	kg.x1	vol.x1
110703-048	● nero/black	x1	100	2,90	mc. 0.02

### 04 aba-telaio schienale esterno portante in plastica aba-outer plastic back

code	finishing	q.kit	q.pack	a	b	kg.x1	vol.x1
132103-065	● nero/black	x1	20	320	460	0,51	mc. 0.005

### 06 aba-cornice schienale in plastica per rete aba-frame back in plastic mesh

code	finishing	q.kit	q.pack	a	b	kg.x1	vol.x1
132103-063	● nero/black	x1	25	250	420	0,25	mc. 0.0025

### 07 aba-coppia inserti schienale destro-sinistro plastica aba-pair back inserts right-left plastic

code	finishing	q.kit	q.pack
132103-066	● nero/black	x1	50

### 10 aba-sedile plastica colorato a vista (tappizzabile) aba-plastic seat colored (to be upholstered)

code	finishing	q.kit	q.pack	a	b	kg.x1	vol.x1
132203-070	● nero/black	x1	10	455	470	1,32	mc. 0.01

### 11 aba-sottosedile plastica colorato a vista+viti aba-pair plastic seat colored+screws

code	finishing	q.kit	q.pack	a	b	kg.x1	vol.x1
132203-071	● nero/black	x1	20	430	410	0,54	mc. 0.005

for the bench components, see page 201



for all colour codes, see page 59

optionals

OPTIONAL  
bench connector

E-USB **NEW**  
bench plug



JIM **NEW**  
bench leg

APOLL  
bench arm



plastic

90GM  
bench leg

90GF  
bench leg

100GM  
bench leg

200GM  
bench leg

PIONEER  
bench arm



metal

CUT  
bench leg

SLIM  
bench leg

CUT  
bench arm

SLIM  
bench arm



aluminium



### plastic colour codes



**16** schienale in plastica  
plastic backrest

- 132102-067 rosso/red 527
- 132103-067 nero/black
- 132104-067 grigio/gray 7035
- 132105-067 bianco/white 218
- 132114-067 viola/violet 145
- 132115-067 blu/blue 5023
- 132116-067 verde/pastel green 6019



**07** coppia inserti schienale  
pair plastic back inserts

- 132102-066 rosso/red 527
- 132103-066 nero/black
- 132104-066 grigio/gray 7035
- 132105-066 bianco/white 218
- 132114-066 viola/violet 145
- 132115-066 blu/blue 5023
- 132116-066 verde/pastel green 6019



**08** coppia braccioli destro-sinistro in plastica  
pair plastic armrests right-left

- 131702-055 rosso/red 527
- 131703-055 nero/black
- 131704-055 grigio/gray 7035
- 131705-055 bianco/white 218
- 131714-055 viola/violet 145
- 131715-055 blu/blue 5023
- 131716-055 verde/pastel green 6019



**09** coppia braccioli destro-sinistro in plastica per tavoletta  
pair plastic armrests right-left for tablet

- 131702-056 rosso/red 527
- 131703-056 nero/black
- 131704-056 grigio/gray 7035
- 131705-056 bianco/white 218
- 131714-056 viola/violet 145
- 131715-056 blu/blue 5023
- 131716-056 verde/pastel green 6019



**10** sedile in plastica  
plastic seat

- 132202-070 rosso/red 527
- 132203-070 nero/black
- 132204-070 grigio/gray 7035
- 132205-070 bianco/white 218
- 132214-070 viola/violet 145
- 132215-070 blu/blue 5023
- 132216-070 verde/pastel green 6019



**11** sottosedile in plastica  
outer plastic seat

- 132202-071 rosso/red 527
- 132203-071 nero/black
- 132204-071 grigio/gray 7035
- 132205-071 bianco/white 218
- 132214-071 viola/violet 145
- 132215-071 blu/blue 5023
- 132216-071 verde/pastel green 6019



**06** cornice schienale in plastica per rete  
frame back in plastic for mesh

- 132103-063 nero/black



**04** telaio schienale esterno portante in plastica  
outer plastic back in plastic

- 132103-065 nero/black



**05** pannello schienale in plastica da tappezzare  
frame back in plastic for upholstery

- 132103-064 nero/black





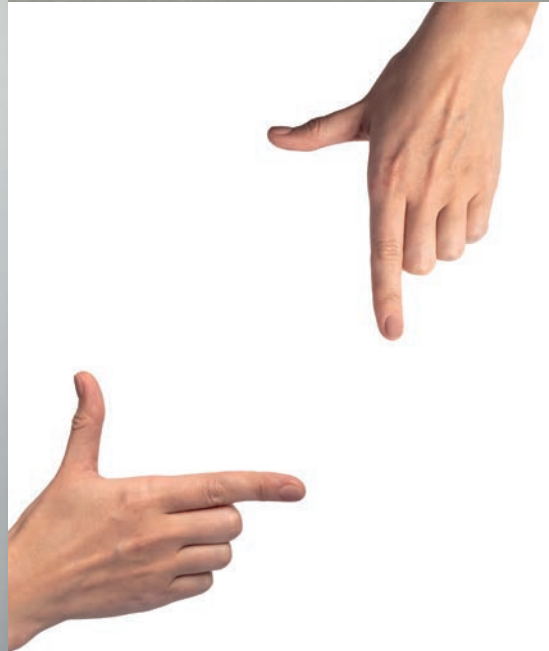



**equity**

---



# equity



---

side

4 legs

4 legs with castors

swivel

bench

## equity showing

---

### features



trolley  
available



Una **seduta ampia e confortevole**. Lo schienale dalla forma accattivante è disponibile sia con pannello in plastica forata, dal disegno caratteristico che lo rende distintivo, sia nella versione da tappezzare sia in rete.

Nata per l'**ambiente Office e Educational**, è adatta a ogni tipo di utilizzo grazie all' ampio assortimento di componenti, completo di tutte le opzioni telaio.

**A large, comfortable seat.** The attractively-shaped backrest is available in a range of versions: a perforated plastic panel with an original, highly distinctive design, a version to be upholstered and also in a mesh version.

Created for **Educational and Office environments**, it is suitable for any type of use thanks to the wide assortment of components, complete with a full range of frame options.



# equity

4-legs



equity-carrello portasedie con accessori  
equity-trolley for chairs with accessories

code	finishing	q.kit
110803-340	● nero/black	x1



main component sizes

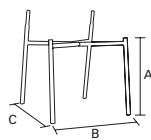

01



07



03

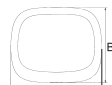

04

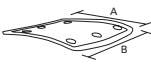

05



06

optional



08

**01** pinko-telaio quattro gambe fisso per braccioli senza tappi  
pinko-fixed four legs frame for arms without caps

code	finishing	q.kit	q.pack	a	b	c	kg.x1	vol.x1
112603-040	● nero/black	x1	80	450	530	530	3,20	mc. 0.035
112604-040	● grigio/grey	x1	80	450	530	530	3,20	mc. 0.035
112610-040	● cromato/chrome	x1	80	450	530	530	3,20	mc. 0.035

**02** confezione puntali a testa sferica d.25  
cap d.25 spherical head black package

code	finishing	q.kit	q.pack
137003-075	● nero/black	x4	120

**03** equity-schienale portante plastica  
equity-plastic back bearing

code	finishing	q.kit	q.pack	a	b	kg.x1	vol.x1
132103-016	● nero/black	x1	10	440	360	0,67	mc. 0.0085
132105-016	○ bianco/white	x1	10	440	360	0,67	mc. 0.0085

**04** equity-cornice schienale per rete  
equity-plastic open frame for mesh back

code	finishing	q.kit	q.pack	a	b	kg.x1	vol.x1
132103-018	● nero/black	x1	20	425	350	0,36	mc. 0.0045
132105-082	○ bianco/white	x1	20	425	350	0,36	mc. 0.0045

**05** pinko-sedile interno da tappezzare  
pinko-inner seat for upholstery

code	finishing	q.kit	q.pack	a	b	kg.x1	vol.x1
132203-025	● nero/black	x1	10	465	470	0,73	mc. 0.006

**06** pinko-sedile esterno plastica  
pinko-outer plastic seat

code	finishing	q.kit	q.pack	a	b	kg.x1	vol.x1
132203-026	● nero/black	x1	20	465	470	0,62	mc. 0.007
132205-026	○ bianco/white	x1	20	465	470	0,62	mc. 0.007

**07** equity-coppia braccioli plastica  
equity-pair of plastic armrest

code	finishing	q.kit	q.pack	a	b	kg.x1	vol.x1
131703-052	● nero/black	x1	10	375	220	0,87	mc. 0.0062
131705-052	○ bianco/white	x1	10	375	220	0,87	mc. 0.0062

**08** pinko/logan-coppia agganci laterale maschio + femmina cromati  
pinko/logan-chrome lateral hooks male + femal with screws

code	finishing	q.kit	q.pack	kg.x1	vol.x1
113410-100	● cromato/chrome	x1	100	0,13	mc. 0.0004

# equity

## 4-legs/tablet accessories

main component sizes



09



### 09 equity-coppia bracciali plastica con gancio tavoletta destro

equity-pair of plastic armrest with right joint for writing tablet

code	finishing	q.kit	q.pack	a	b	kg.x1	vol.x1
131703-053	● nero/black	x1	10	375	220	0,88	mc. 0,0062

TLT  
tablet



TLT2  
tablet



TLT3  
tablet



BEAN  
tablet



TL02  
tablet



SPT2  
mechanism tablet



SPTA  
mechanism antipanic



for writing tablet options, see page 192/193

## 4-legs/backrest options

main component sizes

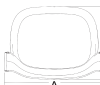

03



### 03 equity-schienale portante plastica

equity-plastic back bearing

code	finishing	q.kit	q.pack	a	b	kg.x1	vol.x1
132103-016	● nero/black	x1	10	440	360	0,67	mc. 0,0085
132105-016	○ bianco/white	x1	10	440	360	0,67	mc. 0,0085



10

### 10 equity-pannello schienale forato in plastica

equity-plastic panel for mesh back

code	finishing	q.kit	q.pack	a	b	kg.x1	vol.x1
132103-017	● nero/black	x1	20	425	350	0,45	mc. 0,0045
132106-017	● neutro/neutral	x1	20	425	350	0,45	mc. 0,0045

main component sizes

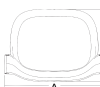

03



### 03 equity-schienale portante plastica

equity-plastic back bearing

code	finishing	q.kit	q.pack	a	b	kg.x1	vol.x1
132103-016	● nero/black	x1	10	440	360	0,67	mc. 0,0085
132105-016	○ bianco/white	x1	10	440	360	0,67	mc. 0,0085



10

### 10 equity-pannello schienale forato in plastica (tappezzabile)

equity-plastic panel for mesh back (to be upholstered)

code	finishing	q.kit	q.pack	a	b	kg.x1	vol.x1
132103-017	● nero/black	x1	20	425	350	0,45	mc. 0,0045
132106-017	● neutro/neutral	x1	20	425	350	0,45	mc. 0,0045

# equity

4-legs for castors



main component sizes

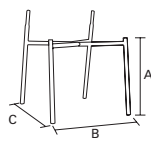

11



07



03

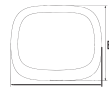

04



05



06



**11** pinko-telaio quattro gambe per ruote + 4 riduttori per ruote  
pinko four legs frame for castors + 4 adapters for castors

code	finishing	q.kit	q.pack	a	b	c	kg.x1	vol.x1
112603-041	● nero/black	x1	80	390	530	530	3,20	mc. 0.035
112604-041	● grigio/grey	x1	80	390	530	530	3,20	mc. 0.035
112610-041	● cromato/chrome	x1	80	390	530	530	3,20	mc. 0.035

**12** doppia ruota d.50 in desmopan con perno montato  
twin wheel castor d.50 desmopan with pivot mounted

code	finishing	q.kit
134403-003	● nero/black	x4

**03** equity-schienale portante plastica  
equity-plastic back bearing

code	finishing	q.kit	q.pack	a	b	kg.x1	vol.x1
132103-016	● nero/black	x1	10	440	360	0,67	mc. 0.0085
132105-016	○ bianco/white	x1	10	440	360	0,67	mc. 0.0085

**04** equity-cornice schienale per rete  
equity-plastic open frame for mesh back

code	finishing	q.kit	q.pack	a	b	kg.x1	vol.x1
132103-018	● nero/black	x1	20	425	350	0,36	mc. 0.0045
132105-082	○ bianco/white	x1	20	425	350	0,36	mc. 0.0045

**05** pinko-sedile interno da tappezzare  
pinko-inner seat for upholstery

code	finishing	q.kit	q.pack	a	b	kg.x1	vol.x1
132203-025	● nero/black	x1	10	465	470	0,73	mc. 0.006

**06** pinko-sedile esterno plastica  
pinko-outer plastic seat

code	finishing	q.kit	q.pack	a	b	kg.x1	vol.x1
132203-026	● nero/black	x1	20	465	470	0,62	mc. 0.007
132205-026	○ bianco/white	x1	20	465	470	0,62	mc. 0.007

**07** equity-coppia braccioli plastica  
equity-pair of plastic armrest

code	finishing	q.kit	q.pack	a	b	kg.x1	vol.x1
131703-052	● nero/black	x1	10	375	220	0,87	mc. 0.0062
131705-052	○ bianco/white	x1	10	375	220	0,87	mc. 0.0062

pinko-carrello portasedie con accessori nero  
pinko-trolley for chairs with accessories black

code	finishing	q.kit
110803-340	● nero/black	x1

# equity

## 4-legs for castors/tablet accessories

main component sizes



09



### 09 equity-coppia braccioni plastica con gancio tavoletta destro

equity-pair of plastic armrest with right joint for writing tablet

code	finishing	q.kit	q.pack	a	b	kg.x1	vol.x1
131703-053	● nero/black	x1	10	375	220	0,88	mc. 0,0062

TLT  
tablet



TLT2  
tablet



TLT3  
tablet



BEAN  
tablet



TL02  
tablet



SPT2  
mechanism tablet



SPTA  
mechanism antipanic



for writing tablet options, see page 192/193

## 4-legs for castors/backrest options

main component sizes

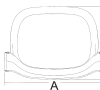

03



10



### 03 equity-schienale portante plastica

equity-plastic back bearing

code	finishing	q.kit	q.pack	a	b	kg.x1	vol.x1
132103-016	● nero/black	x1	10	440	360	0,67	mc. 0,0085
132105-016	○ bianco/white	x1	10	440	360	0,67	mc. 0,0085

### 10 equity-pannello schienale forato in plastica

equity-plastic panel for mesh back

code	finishing	q.kit	q.pack	a	b	kg.x1	vol.x1
132103-017	● nero/black	x1	20	425	350	0,45	mc. 0,0045
132106-017	● neutro/neutral	x1	20	425	350	0,45	mc. 0,0045

main component sizes

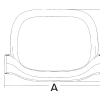

03



10



### 03 equity-schienale portante plastica

equity-plastic back bearing

code	finishing	q.kit	q.pack	a	b	kg.x1	vol.x1
132103-016	● nero/black	x1	10	440	360	0,67	mc. 0,0085
132105-016	○ bianco/white	x1	10	440	360	0,67	mc. 0,0085

### 10 equity-pannello schienale forato in plastica (tappezzabile)

equity-plastic panel for mesh back (to be upholstered)

code	finishing	q.kit	q.pack	a	b	kg.x1	vol.x1
132103-017	● nero/black	x1	20	425	350	0,45	mc. 0,0045
132106-017	● neutro/neutral	x1	20	425	350	0,45	mc. 0,0045

# equity

## slide



main component sizes

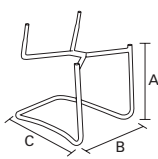

13



07



03



10



05



06

### 13 pinko-base a slitta in tubo asform d.25 tappi esclusi pinko-slide frame pipe d.25 without caps

code	finishing	q.kit	q.pack	a	b	c	kg.x1	vol.x1
110503-093	● nero/black	x1	40	450	550	550	4,60	mc. 0,06
110504-093	● grigio/grey	x1	40	450	550	550	4,60	mc. 0,06
110510-093	● cromato/chrome	x1	40	450	550	550	4,60	mc. 0,06

### 14 paracolpi testa bombata d.18 round head cap d.18

code	finishing	q.kit
134403-101	● nero/black	x4

### 03 equity-schienale portante plastica equity-plastic back bearing

code	finishing	q.kit	q.pack	a	b	kg.x1	vol.x1
132103-016	● nero/black	x1	10	440	360	0,67	mc. 0,0085
132105-016	○ bianco/white	x1	10	440	360	0,67	mc. 0,0085

### 10 equity-pannello schienale forato in plastica equity-plastic panel for mesh back

code	finishing	q.kit	q.pack	a	b	kg.x1	vol.x1
132103-017	● nero/black	x1	20	425	350	0,45	mc. 0,0045
132106-017	● neutro/neutral	x1	20	425	350	0,45	mc. 0,0045

### 05 pinko-sedile interno da tappezzare pinko-inner seat for upholstery

code	finishing	q.kit	q.pack	a	b	kg.x1	vol.x1
132203-025	● nero/black	x1	10	465	470	0,73	mc. 0,006

### 06 pinko-sedile esterno plastica pinko-outer plastic seat

code	finishing	q.kit	q.pack	a	b	kg.x1	vol.x1
132203-026	● nero/black	x1	20	465	470	0,62	mc. 0,007
132205-026	○ bianco/white	x1	20	465	470	0,62	mc. 0,007

### 07 equity-coppia braccioli plastica equity-pair of plastic armrest

code	finishing	q.kit	q.pack	a	b	kg.x1	vol.x1
131703-052	● nero/black	x1	10	375	220	0,87	mc. 0,0062
131705-052	○ bianco/white	x1	10	375	220	0,87	mc. 0,0062

# equity

## slide/backrest options

main component sizes



03

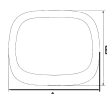

04



### 03 equity-schienale portante plastica equity-plastic back bearing

code	finishing	q.kit	q.pack	a	b	kg.x1	vol.x1
132103-016	● nero/black	x1	10	440	360	0,67	mc. 0.0085
132105-016	○ bianco/white	x1	10	440	360	0,67	mc. 0.0085

### 04 equity-cornice schienale per rete equity-plastic open frame for mesh back

code	finishing	q.kit	q.pack	a	b	kg.x1	vol.x1
132103-018	● nero/black	x1	20	425	350	0,36	mc. 0.0045
132105-082	○ bianco/white	x1	20	425	350	0,36	mc. 0.0045

main component sizes

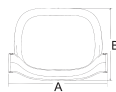

03

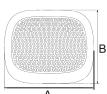

10



### 03 equity-schienale portante plastica equity-plastic back bearing

code	finishing	q.kit	q.pack	a	b	kg.x1	vol.x1
132103-016	● nero/black	x1	10	440	360	0,67	mc. 0.0085
132105-016	○ bianco/white	x1	10	440	360	0,67	mc. 0.0085

### 10 equity-pannello schienale forato in plastica (tappizzabile) equity-plastic panel for mesh back (to be upholstered)

code	finishing	q.kit	q.pack	a	b	kg.x1	vol.x1
132103-017	● nero/black	x1	20	425	350	0,45	mc. 0.0045
132106-017	● neutro/neutral	x1	20	425	350	0,45	mc. 0.0045



# equity

## swivel



main component sizes

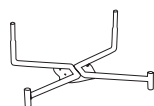

15



07

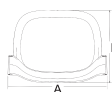

03



10

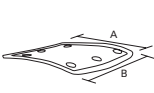

05

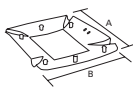

16

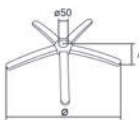

18

optionals

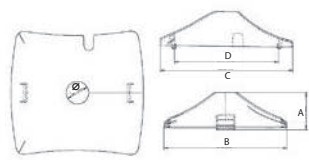

17

### 15 pinko-telaio per girevole comando a gas senza tappi pinko-swivel frame with gas lever without caps

code	finishing	q.kit	q.pack	kg.x1	vol.x1
112603-045	● nero/black	x1	80	2,60	mc. 0.005
112604-045	● grigio/grey	x1	80	2,60	mc. 0.005

### 03 equity-schienale portante plastica equity-plastic back bearing

code	finishing	q.kit	q.pack	a	b	kg.x1	vol.x1
132103-016	● nero/black	x1	10	440	360	0,67	mc. 0.0085
132105-016	○ bianco/white	x1	10	440	360	0,67	mc. 0.0085

### 10 equity-pannello schienale forato in plastica (tappizzabile) equity-plastic panel for mesh back (to be upholstered)

code	finishing	q.kit	q.pack	a	b	kg.x1	vol.x1
132103-017	● nero/black	x1	20	425	350	0,45	mc. 0.0045
132106-017	● neutro/neutral	x1	20	425	350	0,45	mc. 0.0045

### 05 pinko-sedile interno da tappezzare pinko-inner seat for upholstery

code	finishing	q.kit	q.pack	a	b	kg.x1	vol.x1
132203-025	● nero/black	x1	10	465	470	0,73	mc. 0.006

### 16 pinko-sedile esterno plastica per girevole e panca pinko-plastic outer seat for swivel and bench

code	finishing	q.kit	q.pack	a	b	kg.x1	vol.x1
132203-027	● nero/black	x1	20	465	470	0,62	mc. 0.007

### 07 equity-coppia braccioli plastica equity-pair of plastic armrest

code	finishing	q.kit	q.pack	a	b	kg.x1	vol.x1
131703-052	● nero/black	x1	10	375	220	0,87	mc. 0.0062
131705-052	○ bianco/white	x1	10	375	220	0,87	mc. 0.0062

### 17 cpq-copertina in plastica per telaio girevole cpq-plastic cover for swivel frame

code	finishing	q.kit	q.pack	a	b	c	d	o	kg.x1	vol.x1
130903-000	● nero/black	x1	50	60	200	210	167	36	0,1	mc. 0.0015

### 18 b40 base in metallo d.640 con coprisaldatura b40 metal base d.640 with cover welding

code	finishing	q.kit	q.pack	a	o	kg.x1	vol.x1
110210-027	● cromato/chrome	x1	5	60	640	2,85	mc. 0.014

CPG  
plastic cover for swivel frame



# equity

## swivel/backrest options

main component sizes



03

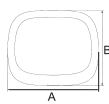

04



### 03 equity-schienale portante plastica equity-plastic back bearing

code	finishing	q.kit	q.pack	a	b	kg.x1	vol.x1
132103-016	● nero/black	x1	10	440	360	0,67	mc. 0.0085
132105-016	○ bianco/white	x1	10	440	360	0,67	mc. 0.0085

### 04 equity-cornice schienale per rete equity-plastic open frame for mesh back

code	finishing	q.kit	q.pack	a	b	kg.x1	vol.x1
132103-018	● nero/black	x1	20	425	350	0,36	mc. 0.0045
132105-082	○ bianco/white	x1	20	425	350	0,36	mc. 0.0045

main component sizes



03

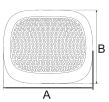

10



### 03 equity-schienale portante plastica equity-plastic back bearing

code	finishing	q.kit	q.pack	a	b	kg.x1	vol.x1
132103-016	● nero/black	x1	10	440	360	0,67	mc. 0.0085
132105-016	○ bianco/white	x1	10	440	360	0,67	mc. 0.0085

### 10 equity-pannello schienale forato in plastica equity-plastic panel for mesh back

code	finishing	q.kit	q.pack	a	b	kg.x1	vol.x1
132103-017	● nero/black	x1	20	425	350	0,45	mc. 0.0045
132106-017	● neutro/neutral	x1	20	425	350	0,45	mc. 0.0045

# equity

## bench



main component sizes

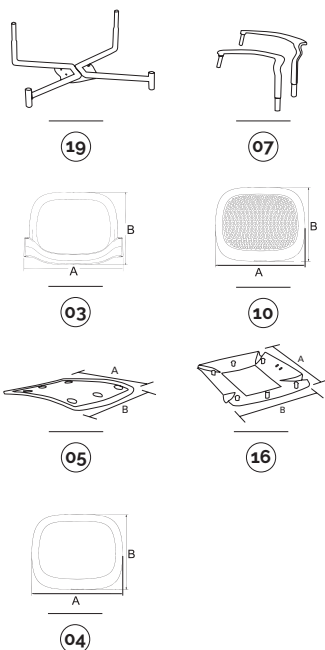

### 19 pinko-telaio per panca senza tappi pinko-bench frame caps excluded

code	finishing	q.kit	q.pack	kg.x1	vol.x1
110703-072	● nero/black	x1	80	2,50	mc. 0.005
110704-072	● grigio/grey	x1	80	2,50	mc. 0.005

### 03 equity-schienale portante plastica equity-plastic back bearing

code	finishing	q.kit	q.pack	a	b	kg.x1	vol.x1
132103-016	● nero/black	x1	10	440	360	0,67	mc. 0.0085
132105-016	○ bianco/white	x1	10	440	360	0,67	mc. 0.0085

### 10 equity-pannello schienale forato in plastica (tappizzabile) equity-plastic panel for mesh back (to be upholstered)

code	finishing	q.kit	q.pack	a	b	kg.x1	vol.x1
132103-017	● nero/black	x1	20	425	350	0,45	mc. 0.0045
132106-017	● neutro/neutral	x1	20	425	350	0,45	mc. 0.0045

### 05 pinko-sedile interno da tappezzare pinko-inner seat for upholstery

code	finishing	q.kit	q.pack	a	b	kg.x1	vol.x1
132203-025	● nero/black	x1	10	465	470	0,73	mc. 0.006

### 16 pinko-sedile esterno plastica per girevole e panca pinko-plastic outer seat for swivel and bench

code	finishing	q.kit	q.pack	a	b	kg.x1	vol.x1
132203-027	● nero/black	x1	20	465	470	0,62	mc. 0.007

### 07 equity-coppia braccioli plastica equity-pair of plastic armrest

code	finishing	q.kit	q.pack	a	b	kg.x1	vol.x1
131703-052	● nero/black	x1	10	375	220	0,87	mc. 0.0062
131705-052	○ bianco/white	x1	10	375	220	0,87	mc. 0.0062

### 04 equity-cornice schienale per rete equity-plastic open frame for mesh back

code	finishing	q.kit	q.pack	a	b	kg.x1	vol.x1
132103-018	● nero/black	x1	20	425	350	0,36	mc. 0.0045
132105-082	○ bianco/white	x1	20	425	350	0,36	mc. 0.0045

for the bench components, see page 201

OPTIONAL  
bench connector

E-USB **NEW**  
bench plug



JIM **NEW**  
bench leg

APOLL  
bench arm



plastic

90GM  
bench leg

90GF  
bench leg

100GM  
bench leg

200GM  
bench leg

PIONEER  
bench arm



metal

CUT  
bench leg

SLIM  
bench leg

CUT  
bench arm

SLIM  
bench arm



aluminium







BEYOND | **Solutions**

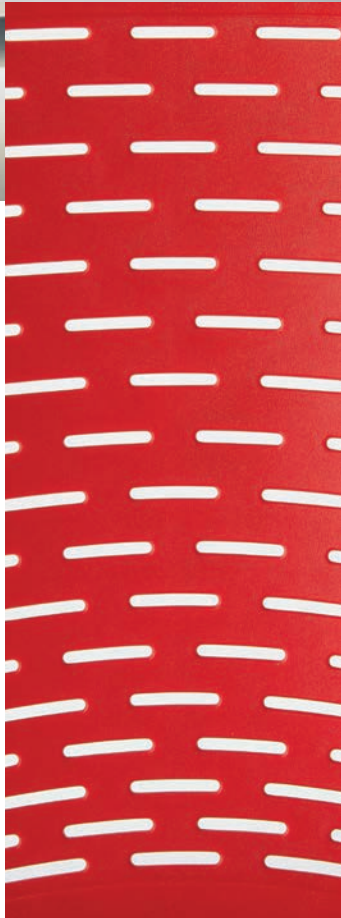



**X3**





# X3



---

slide  
slide w/armrests  
slide w/writing tablet

4 legs  
4 legs w/armrest  
4 legs w/writing tablet

swivel  
swivel w/armrest

bench  
bench w/armrest

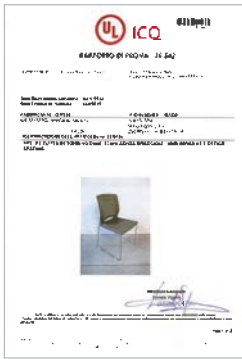

BIFMA TEST



BIFMA TEST



tools



certification

x3 showing



Una **seduta in plastica** disponibile in 4 colori, caratterizzata da un **design distintivo**.

Prevede diverse versioni: schienale in plastica pieno o traforato, schienale in rete, pannelli sedile e schienale in plastica da tappezzare.

È inoltre possibile scegliere tra un ampio assortimento di telai, offrendo così soluzioni differenti per ambienti **Office e Community**, grazie anche alla pratica impilabilità.

**X3** è una seduta **certificata CATAS e BIFMA**.

*Plastic chair available in 4 colours, characterized by a **distinctive design**.*

*Available in a range of different versions: solid or perforated plastic back, mesh back, or seat and back panels in plastic to be upholstered.*

*With a wide selection of frames to choose from it offers a full range of solutions for **Office and Community** environments, and its stackability means it's also highly practical.*

***X3 is CATAS and BIFMA certified.***

# X3 slide

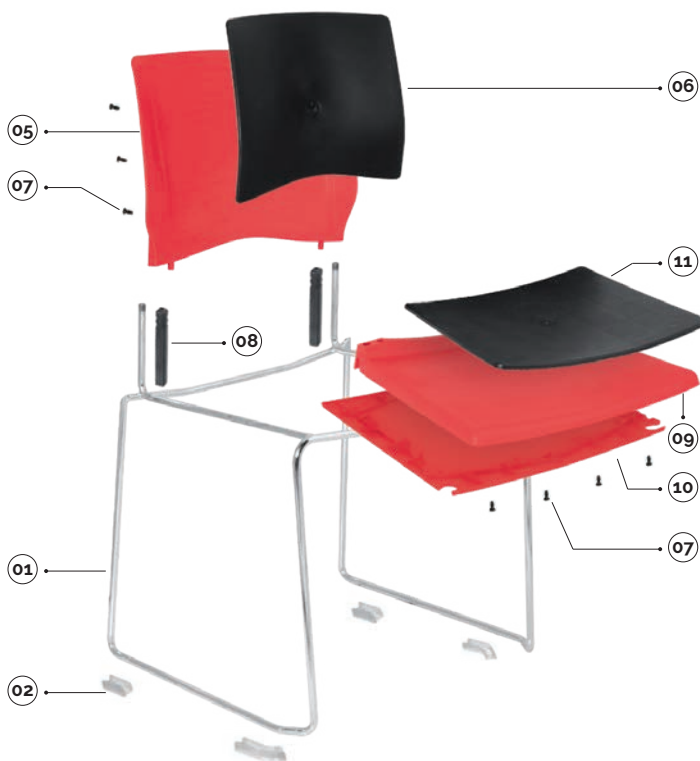

plastic colours

- grigio/gray ral 7003
- nero/black
- rosso/red 527
- bianco/white ral 1013

x3-carrello portasedie con accessori  
x3-trolley for chairs with accessories

code	finishing	q.kit	kg.x1
110803-346	● nero/black	x1	10,50

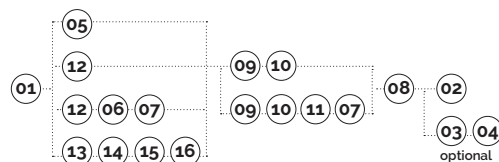

main component sizes

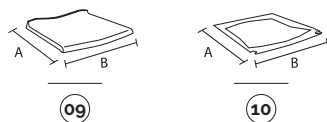
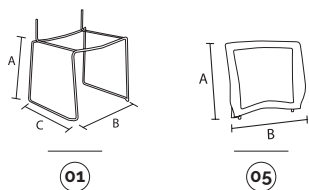

optional

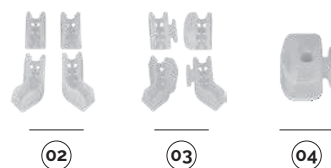

01 x3-telaio a slitta in tondino d.12  
x3-slide wire frame d.12

code	finishing	q.kit	q.pack	a	b	c	kg.x1	vol.x1
113410-062	● cromato/chrome	x1	60	450	530	505	4,20	mc. 0,03

02 btf-kit piedini  
btf-kit feet

code	finishing	q.kit	q.pack	kg.x1
134306-001	○ neutro/neutral	x1	100	0,05

03 btf-kit piedini con ganci  
btf-kit feet with hooks

code	finishing	q.kit	q.pack	kg.x1
134306-002	○ neutro/neutral	x1	100	0,06

04 pptf-tappo per fissaggio pavimento  
pptf-cap for fixing to the floor

code	finishing	q.kit	q.pack	kg.x1
134306-003	○ neutro/neutral	x2	100	0,03

05 x3-schienale colorato a vista in plastica pieno  
x3-colored full plastic back

code	finishing	q.kit	q.pack	a	b	kg.x1	vol.x1
132102-090	● rosso/red	x1	10	400	460	0,90	mc. 0,008

08 x3-riduttore per schienale in plastica  
x3-plastic adapter for the back

code	finishing	q.kit	q.pack	kg.x1	vol.x1
132103-009	● nero/black	x2	200	0,019	mc. 0,0001

09 x3-sedile colorato a vista in plastica per telaio slitta  
x3-colored plastic seat for wire frame

code	finishing	q.kit	q.pack	a	b	kg.x1	vol.x1
132202-019	● rosso/red	x1	10	450	460	1,20	mc. 0,015

10 x3-sottosedile colorato a vista in plastica  
x3-outer colored plastic seat

code	finishing	q.kit	q.pack	a	b	kg.x1	vol.x1
132202-009	● rosso/red	x1	20	450	460	0,73	mc. 0,007



for all colour codes, see page 93

# X3

## slide/backrest and seat options

main component sizes

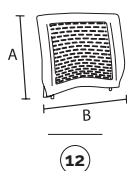

12



CERTIFIED BY  
**BIFMA**

**12** x3-schienale colorato a vista in plastica forato  
x3-colored plastic back with holes

code	finishing	q.kit	q.pack	a	b	kg.x1	vol.x1
132102-019	● rosso/red 527	x1	10	400	460	0,90	mc. 0.008

and · (09) (10)

main component sizes

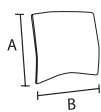

06



**06** x3-pannello schienale da tappezzare in plastica  
x3-back panel for upholstery

code	finishing	q.kit	q.pack	a	b	kg.x1	vol.x1
132103-008	● nero/black	x1	20	350	385	0,50	mc. 0.003

**11** x3-pannello sedile da tappezzare in plastica  
x3-seat panel for upholstery

code	finishing	q.kit	q.pack	a	b	kg.x1	vol.x1
132203-003	● nero/black	x1	20	400	410	0,60	mc. 0.003

**07** vite hilo tb+ 5x12 cementata brunita nera  
screw tb+fr.hilo 5x12 black burnished

code	finishing	q.kit seat	q.kit back
117803-154	● nero/black	x8	x6

and · (12) (09) (10)

main component sizes

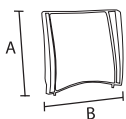

13



**13** x3-schienale per rete nero a vista in plastica  
x3-black plastic for mesh back

code	finishing	q.kit	q.pack	a	b	kg.x1	vol.x1
132103-014	● nero/black	x1	10	400	460	0,60	mc. 0.008

**14** x3-liste a\*b per schienale rete nere a vista  
x3-black plastic strips a\*b for mesh back

code	finishing	q.kit	q.pack	kg.x1	vol.x1
132103-013	● nero/black	x1	100	0,21	mc. 0.0004

**15** x3-rete per schienale  
x3-net for back

code	finishing	q.kit	q.pack	a	b	kg.x1	vol.x1
132103-029	● nero/black	x1	50	400	460	0,14	mc. 0.0057

**16** vite truciolare tsp+ d.3,5x10 brunita nera(per fissare schienale rete)  
shaving screw tsp+ d.3,5x10 zinc.(to fix mesh back)

code	finishing	q.kit
117803-105	● nero/black	x8

and · (09) (10) (11) (07)

# X3

slide w/writing tablet

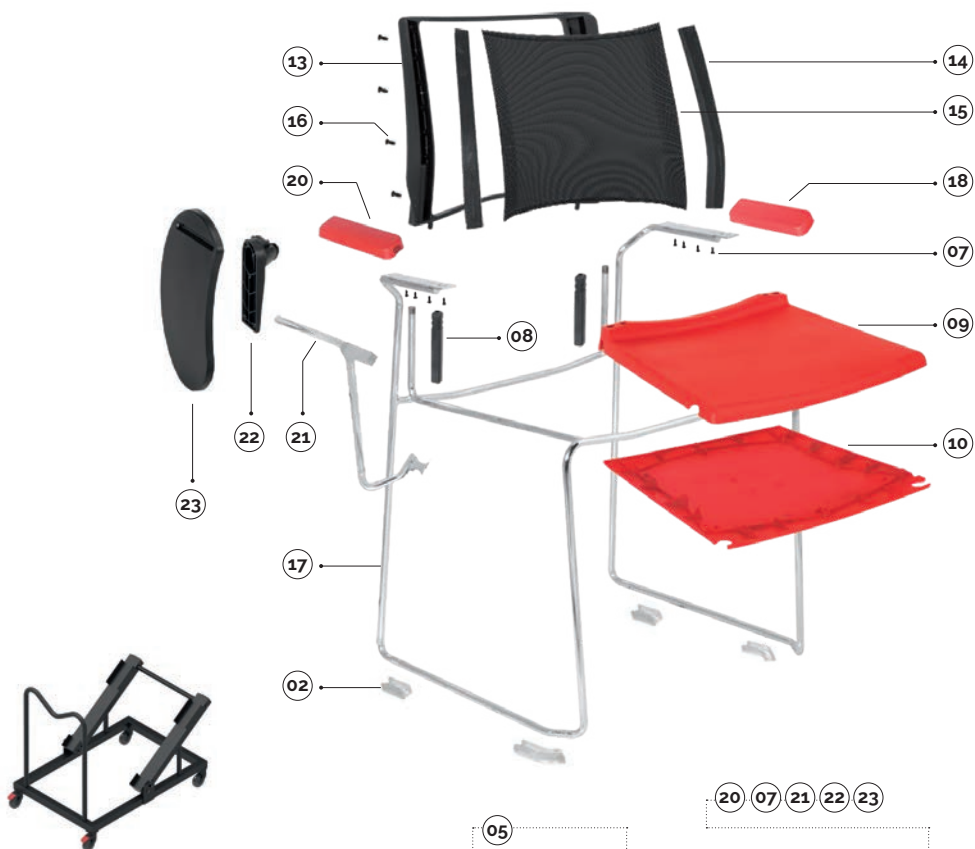

plastic colours

- grigio/gray ral 7003
- nero/black
- rosso/red 527
- bianco/white ral 1013

x3-carrello portasedie con accessori  
x3-trolley for chairs with accessories

code	finishing	q.kit	kg.x1
110803-346	● nero/black	x1	10,50

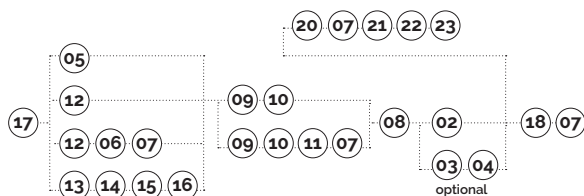

main component sizes

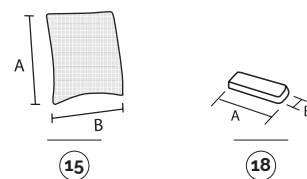
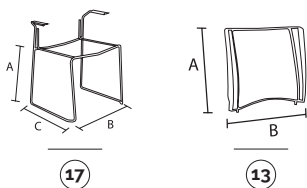

optiopnals

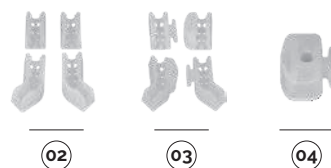

**17** x3-telaio a slitta in tondino d.12 con braccioli  
x3-slide wire frame d.12 with arms

code	finishing	q.kit	q.pack	a	b	c	kg.x1	vol.x1
113410-061	● cromato/chrome	x1	60	450	530	505	5,00	mc. 0.0035

**13** x3-schienale per rete nero a vista in plastica  
x3-black plastic for mesh back

code	finishing	q.kit	q.pack	a	b	kg.x1	vol.x1
132103-014	● nero/black	x1	10	400	460	0,60	mc. 0.008

**14** x3-liste a\*b per schienale rete nere a vista  
x3-black plastic strips a\*b for mesh back

code	finishing	q.kit	q.pack	kg.x1	vol.x1
132103-013	● nero/black	x1	100	0,21	mc. 0.0004

**15** x3-rete per schienale  
x3-net for back

code	finishing	q.kit	q.pack	a	b	kg.x1	vol.x1
132103-029	● nero/black	x1	50	400	460	0,14	mc. 0.0057

**16** vite truciolare tsp+ d.3,5x10 brunita nera(per fissare schienale rete)  
shaving screw tsp+ d.3,5x10 zinc.(to fix mesh back)

code	finishing	q.kit
117803-105	● nero/black	x8

**18** x3-bracciolo plastica colorato per telaio filo  
x3-colored plastic arm for wire frame

code	finishing	q.kit	q.pack	a	b	kg.x1	vol.x1	
131702-019	● rosso/red	527	x2	40	175	55	0,10	mc. 0.0004

**07** vite hilo tb+ 5x12 cementata brunita nera  
screw tb+fr.hilo 5x12 black burnished

code	finishing	q.kit seat	q.kit back
117803-154	● nero/black	x8	x6

for the components below, see page 78

02 03 04 08 09 10



for all colour codes, see page 93

# X3

## slide/tablet accessories

main component sizes

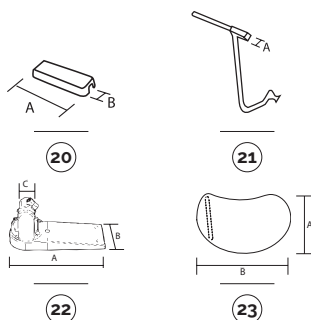

### 20 x3-bracciolo plastica colorato per telaio filo con tavoletta

x3-colored plastic arm for wire frame with tablet

code	finishing		q.kit	q.pack	a	b	kg.x1	vol.x1
131702-018	● rosso/red	527	x2	40	175	55	0,10	mc. 0,0004

### 21 x3-supperto tavoletta per slitta + viti

x3-tablet support for slide wire frame d.12 + screws

code	finishing		q.kit	q.pack		kg.x1	vol.x1
111703-044	● nero/black	destra/right - slitta/slide	x1	10	15x15	0,60	mc. 0,002
111703-047	● nero/black	sinistro/left - slitta/slide	x1	10	15x15	0,60	mc. 0,002
111710-044	● cromato/chrome	destra/right - slitta/slide	x1	10	15x15	0,60	mc. 0,002
111710-047	● cromato/chrome	sinistro/left - slitta/slide	x1	10	15x15	0,60	mc. 0,002

### 22 spt2-snodo per tavoletta in plastica

spt2-mechanism for writing tablet in plastic

code	finishing		q.kit	q.pack	a	b	c	kg.x1	vol.x1
134003-039	● nero/black		x1	20	180	66	15x15	0,35	mc. 0,0006

### 23 bean-tavoletta in plastica spessore 16

bean-writing tablet in plastic thickness 16 mm

code	finishing		q.kit	q.pack	a	b	kg.x1	vol.x1
134003-044	● nero/black		x1	20	235	370	0,40	mc. 0,002



for writing tablet options, see page 192/193

## slide w/armrests/backrest and seat options

main component sizes

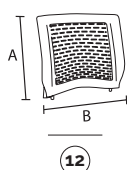

### 12 x3-schienale colorato a vista in plastica forato

x3-colored plastic back with holes

code	finishing		q.kit	q.pack	a	b	kg.x1	vol.x1
132102-019	● rosso/red	527	x1	10	400	460	0,90	mc. 0,008

and · 09 10

main component sizes

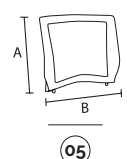

### 05 x3-schienale colorato a vista in plastica pieno

x3-colored full plastic back

code	finishing		q.kit	q.pack	a	b	kg.x1	vol.x1
132102-090	● rosso/red	527	x1	10	400	460	0,90	mc. 0,008

and · 09 10

main component sizes

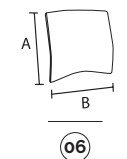

### 06 x3-pannello schienale da tappezzare in plastica

x3-back panel for upholstery

code	finishing		q.kit	q.pack	a	b	kg.x1	vol.x1
132103-008	● nero/black		x1	20	350	385	0,50	mc. 0,003

### 11 x3-pannello sedile da tappezzare in plastica

x3-seat panel for upholstery

code	finishing		q.kit	q.pack	a	b	kg.x1	vol.x1
132203-003	● nero/black		x1	20	400	410	0,60	mc. 0,003

### 07 vite hilo tb\* 5x12 cementata brunita nera

screw tb+fr.hilo 5x12 black burnished

code	finishing	q.kit seat	q.kit back
117803-154	● nero/black	x8	x6

and · 12 09 10



# X3

## 4-legs

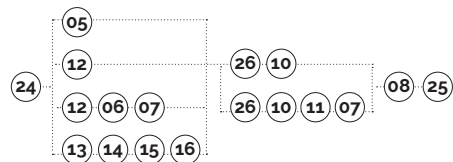
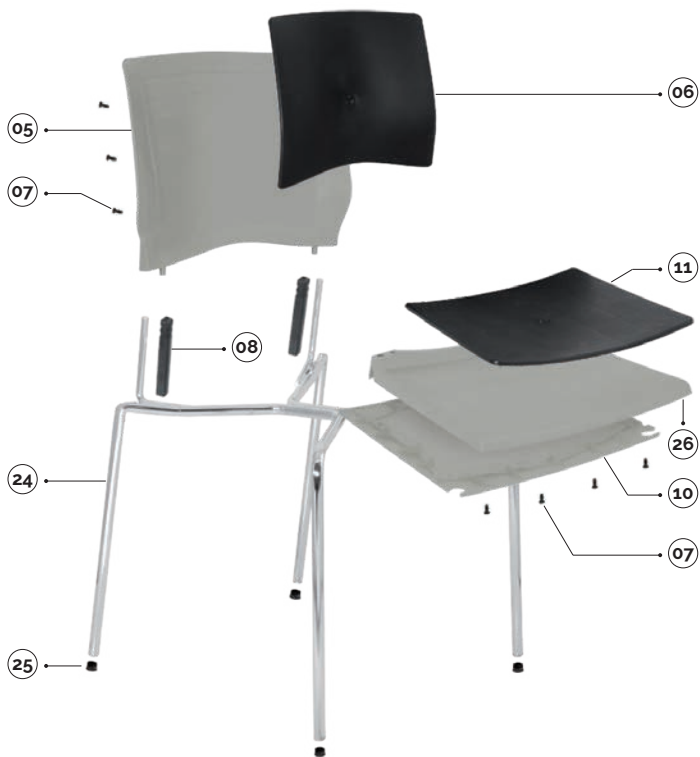

plastic colours

- grigio/gray ral 7003
- nero/black
- rosso/red 527
- bianco/white ral 1013

**x3-carrello portasedie con accessori**  
x3-trolley for chairs with accessories

code	finishing	q.kit	kg.x1
110803-346	● nero/black	x1	10,50

main component sizes

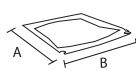
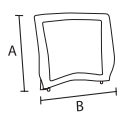
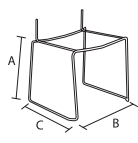

**24** x3-telaio 4 gambe d.18  
x3-4 legs frame d.18

code	finishing	q.kit	q.pack	a	b	c	kg.x1	vol.x1
112703-050	● nero/black	x1	60	455	465	550	2,20	mc. 0.03
112704-050	● grigio/gray	x1	60	455	465	550	2,20	mc. 0.03
112710-050	● cromato/chrome	x1	60	455	465	550	2,20	mc. 0.03

**25** confezione puntali tondi d.18 neri  
black inner round caps d.18 package

code	finishing	q.kit	q.pack
137003-072	● nero/black	x4	200

**05** x3-schienale colorato a vista in plastica pieno  
x3-colored full plastic back

code	finishing	q.kit	q.pack	a	b	kg.x1	vol.x1
132104-090	● grigio/gray ral7003	x1	10	400	460	0,90	mc. 0.008

**08** x3-riduttore per schienale in plastica  
x3-plastic adapter for the back

code	finishing	q.kit	q.pack	kg.x1	vol.x1
132103-009	● nero/black	x2	200	0,019	mc. 0.0001

**26** x3-sedile colorato a vista in plastica per telaio 4 gambe  
x3-colored plastic seat for 4-legs frame

code	finishing	q.kit	q.pack	a	b	kg.x1	vol.x1
132204-018	● grigio/gray ral7003	x1	10	450	460	1,20	mc. 0.015

**10** x3-sottosedile colorato a vista in plastica  
x3-outer colored plastic seat

code	finishing	q.kit	q.pack	a	b	kg.x1	vol.x1
132204-009	● grigio/gray ral7003	x1	20	450	460	0,73	mc. 0.007



for all colour codes, see page 93

# X3

## 4-legs/backrest and seat options

main component sizes

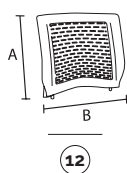

**12** x3-schienale colorato a vista in plastica forato  
x3-colored plastic back with holes

code	finishing	q.kit	q.pack	a	b	kg.x1	vol.x1
132102-019	● rosso/red 527	x1	10	400	460	0,90	mc. 0.008

and · **26** **10**

main component sizes

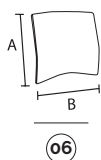

**06** x3-pannello schienale da tappezzare in plastica  
x3-back panel for upholstery

code	finishing	q.kit	q.pack	a	b	kg.x1	vol.x1
132103-008	● nero/black	x1	20	350	385	0,50	mc. 0.003

**11** x3-pannello sedile da tappezzare in plastica  
x3-seat panel for upholstery

code	finishing	q.kit	q.pack	a	b	kg.x1	vol.x1
132203-003	● nero/black	x1	20	400	410	0,60	mc. 0.003

**07** vite hilo tb+ 5x12 cementata brunita nera  
screw tb+fr.hilo 5x12 black burnished

code	finishing	q.kit seat	q.kit back
117803-154	● nero/black	x8	x6

and · **12** **26** **10**

main component sizes

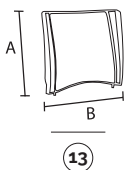

**13** x3-schienale per rete nero a vista in plastica  
x3-black plastic for mesh back

code	finishing	q.kit	q.pack	a	b	kg.x1	vol.x1
132103-014	● nero/black	x1	10	400	460	0,60	mc. 0.008

**14** x3-liste a\*b per schienale rete nere a vista  
x3-black plastic strips a\*b for mesh back

code	finishing	q.kit	q.pack	kg.x1	vol.x1
132103-013	● nero/black	x1	100	0,21	mc. 0.0004

**15** x3-rete per schienale  
x3-net for back

code	finishing	q.kit	q.pack	a	b	kg.x1	vol.x1
132103-029	● nero/black	x1	50	400	460	0,14	mc. 0.0057

**16** vite truciolare tsp+ d.3,5x10 brunita nera(per fissare schienale rete)  
shaving screw tsp+ d.3,5x10 zinc.(to fix mesh back)

code	finishing	q.kit
117803-105	● nero/black	x8

and · **26** **10** **11** **07**

# X3

4-legs w/writing tablet

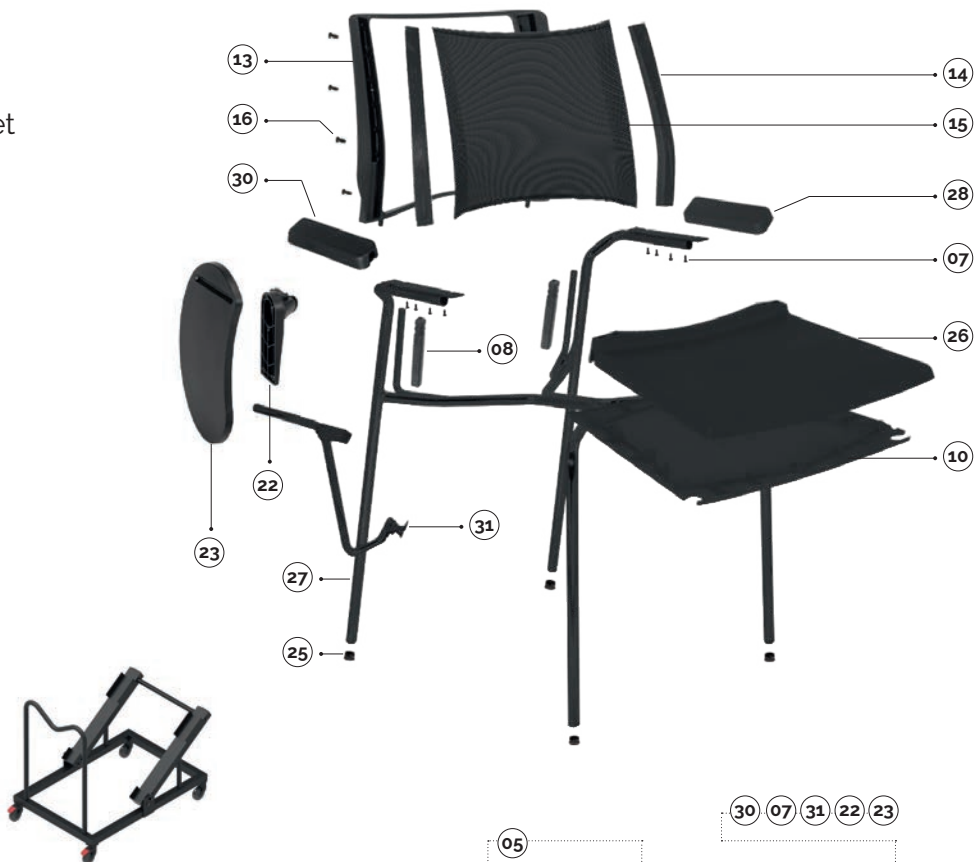

plastic colours

- grigio/gray ral 7003
- nero/black
- rosso/red 527
- bianco/white ral 1013

x3-carrello portasedie con accessori  
x3-trolley for chairs with accessories

code	finishing	q.kit	kg.x1
110803-346	● nero/black	x1	10,50

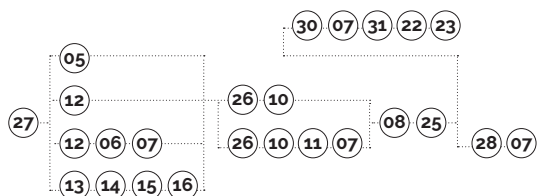

main component sizes

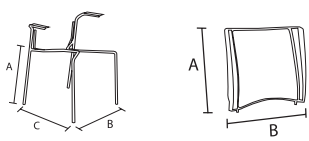

27

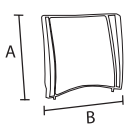

13

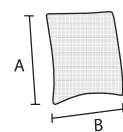

15

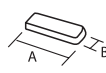

28

27 x3-telaio 4 gambe d.18 con braccioli  
x3-4 legs frame d.18 with arms

code	finishing	q.kit	q.pack	a	b	c	kg.x1	vol.x1
112703-051	● nero/black	x1	60	455	465	550	2,80	mc. 0.035
112704-051	● grigio/gray	x1	60	455	465	550	2,80	mc. 0.035
112710-054	● cromato/chrome	x1	60	455	465	550	2,80	mc. 0.035

13 x3-schienale per rete nero a vista in plastica  
x3-black plastic for mesh back

code	finishing	q.kit	q.pack	a	b	kg.x1	vol.x1
132103-014	● nero/black	x1	10	400	460	0,60	mc. 0.008

14 x3-liste a+b per schienale rete nere a vista  
x3-black plastic strips a+b for mesh back

code	finishing	q.kit	q.pack	kg.x1	vol.x1
132103-013	● nero/black	x1	100	0,21	mc. 0.0004

15 x3-rete per schienale  
x3-net for back

code	finishing	q.kit	q.pack	a	b	kg.x1	vol.x1
132103-029	● nero/black	x1	50	400	460	0,14	mc. 0.0057

16 vite trucciolare tsp+ d.3,5x10 brunita nera(per fissare schienale rete)  
shaving screw tsp+ d.3,5x10 zinc.(to fix mesh back)

code	finishing	q.kit
117803-105	● nero/black	x8

28 x3-bracciolo plastica colorato per telaio 4 gambe  
x3-colored plastic arm for 4 legs frame

code	finishing	q.kit	q.pack	a	b	kg.x1	vol.x1
131703-017	● nero/black	x2	40	175	55	0,10	mc. 0.0004

07 vite hilo tb+ 5x12 cementata brunita nera  
screw tb+fr:hilo 5x12 black burnished

code	finishing	q.kit seat	q.kit back
117803-154	● nero/black	x8	x6

for the components below, see page 82

25 08 26 10



for all colour codes, see page 93

# X3

## 4-legs/tablet accessories

main component sizes

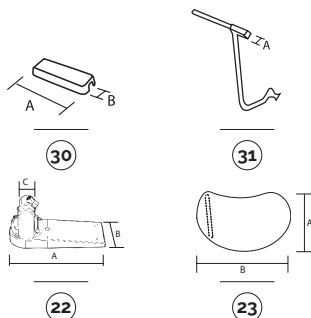

### 30 x3-bracciolo plastica colorato per telaio 4 gambe con tavoletta

x3-colored plastic arm for 4 legs frame with tablet

code	finishing	q.kit	q.pack	a	b	kg.x1	vol.x1
131703-014	● nero/black	x2	40	175	55	0,10	mc. 0,0004

### 31 x3-supperto tavoletta per 4 gambe + viti

x3-tablet support for 4 legs frame + screws

code	finishing	q.kit	q.pack	kg.x1	vol.x1
111703-043	● nero/black destro/right - 4 gambe/legs	x1	10	15x15	0,60 mc. 0,002
111703-046	● nero/black sinistro/left - 4 gambe/legs	x1	10	15x15	0,60 mc. 0,002
111710-037	● cromato/chrome destro/right - 4 gambe/legs	x1	10	15x15	0,60 mc. 0,002
111710-039	● cromato/chrome sinistro/left - 4 gambe/legs	x1	10	15x15	0,60 mc. 0,002

### 22 spt2-snodo per tavoletta in plastica

spt2-mechanism for writing tablet in plastic

code	finishing	q.kit	q.pack	a	b	c	kg.x1	vol.x1
134003-039	● nero/black	x1	20	180	66	15x15	0,35	mc. 0,0006

### 23 bean-tavoletta in plastica spessore 16

bean-writing tablet in plastic thickness 16 mm

code	finishing	q.kit	q.pack	a	b	kg.x1	vol.x1
134003-044	● nero/black	x1	20	235	370	0,40	mc. 0,002



for writing tablet options, see page 192/193

## 4-legs w/armrests/backrest and seat options

main component sizes

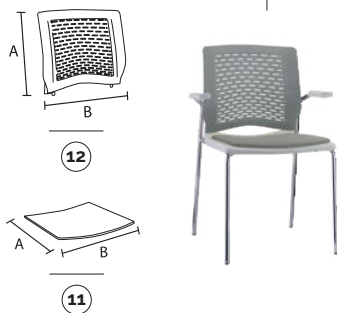

CERTIFIED BY  
**BIFMA**

### 12 x3-schienale colorato a vista in plastica forato

x3-colored plastic back with holes

code	finishing	q.kit	q.pack	a	b	kg.x1	vol.x1
132104-019	● grigio/gray ral 7003	x1	10	400	460	0,90	mc. 0,008

### 11 x3-pannello sedile da tappezzare in plastica

x3-seat panel for upholstery

code	finishing	q.kit	q.pack	a	b	kg.x1	vol.x1
132203-003	● nero/black	x1	20	400	410	0,60	mc. 0,003

### 07 vite hilo tb\* 5x12 cementata brunita nera

screw tb+fr.hilo 5x12 black burnished

code	finishing	q.kit seat	q.kit back
117803-154	● nero/black	x8	x6

and **26 10**

main component sizes

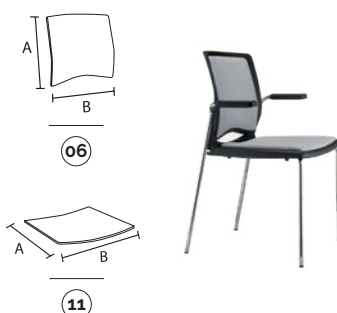

### 06 x3-pannello schienale da tappezzare in plastica

x3-back panel for upholstery

code	finishing	q.kit	q.pack	a	b	kg.x1	vol.x1
132103-008	● nero/black	x1	20	350	385	0,50	mc. 0,003

### 11 x3-pannello sedile da tappezzare in plastica

x3-seat panel for upholstery

code	finishing	q.kit	q.pack	a	b	kg.x1	vol.x1
132203-003	● nero/black	x1	20	400	410	0,60	mc. 0,003

### 07 vite hilo tb\* 5x12 cementata brunita nera

screw tb+fr.hilo 5x12 black burnished

code	finishing	q.kit seat	q.kit back
117803-154	● nero/black	x8	x6

and **12 26 10**

# X3 swivel

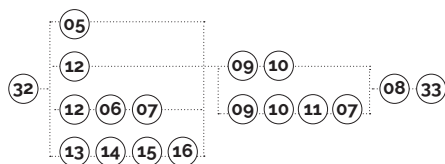

plastic colours

- grigio/gray ral 7003
- nero/black
- rosso/red 527
- bianco/white ral 1013

main component sizes



32

33

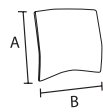
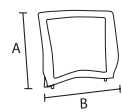

05

06

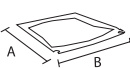

09

10

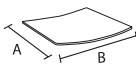

11

### 32 x3-telaio girevole a gas x3-swivel wire frame d.12

code	finishing	q.kit	q.pack	kg.x1	vol.x1
110903-028	● nero/black	x1	100	3,00	mc. 0,02
110904-014	● grigio/gray	x1	100	3,00	mc. 0,02

### 33 b40 base in metallo d.640 con coprisaldatura b40 metal base d.640 with cover welding

code	finishing	q.kit	q.pack	a	o	kg.x1	vol.x1
110210-027	● cromato/chrome	x1	5	60	640	2,85	mc. 0,014

### 05 x3-schienale colorato a vista in plastica pieno x3-colored full plastic back

code	finishing	q.kit	q.pack	a	b	kg.x1	vol.x1
132105-090	○ bianco/white ral 1013	x1	10	400	460	0,90	mc. 0,008

### 06 x3-pannello schienale da tappezzare in plastica x3-back panel for upholstery

code	finishing	q.kit	q.pack	a	b	kg.x1	vol.x1
132103-008	● nero/black	x1	20	350	385	0,50	mc. 0,003

### 07 vite hilo tb\* 5x12 cementata brunita nera screw tb+fr.hilo 5x12 black burnished

code	finishing	q.kit seat	q.kit back
117803-154	● nero/black	x8	x6

### 08 x3-riduttore per schienale in plastica x3-plastic adapter for the back

code	finishing	q.kit	q.pack	kg.x1	vol.x1
132103-009	● nero/black	x2	200	0,019	mc. 0,0001

### 09 x3-sedile colorato a vista in plastica per telaio slitta x3-colored plastic seat for wire frame

code	finishing	q.kit	q.pack	a	b	kg.x1	vol.x1
132205-019	○ bianco/white ral 1013	x1	10	450	460	1,20	mc. 0,015

### 10 x3-sottosedile colorato a vista in plastica x3-outer colored plastic seat

code	finishing	q.kit	q.pack	a	b	kg.x1	vol.x1
132205-009	○ bianco/white ral 1013	x1	20	450	460	0,73	mc. 0,007

### 11 x3-pannello sedile da tappezzare in plastica x3-seat panel for upholstery

code	finishing	q.kit	q.pack	a	b	kg.x1	vol.x1
132203-003	● nero/black	x1	20	400	410	0,60	mc. 0,003



# X3

## swivel/backrest and seat options

main component sizes

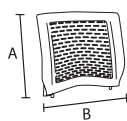

12



**12** x3-schienale colorato a vista in plastica forato  
x3-colored plastic back with holes

code	finishing	q.kit	q.pack	a	b	kg.x1	vol.x1
132105-019	○ bianco/white ral 1013	x1	10	400	460	0,90	mc. 0,008

and · **09** **10**

main component sizes

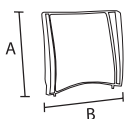

13



**13** x3-schienale per rete nero a vista in plastica  
x3-black plastic for mesh back

code	finishing	q.kit	q.pack	a	b	kg.x1	vol.x1
132103-014	● nero/black	x1	10	400	460	0,60	mc. 0,008

**14** x3-liste a\*b per schienale rete nere a vista  
x3-black plastic strips a\*b for mesh back

code	finishing	q.kit	q.pack	kg.x1	vol.x1
132103-013	● nero/black	x1	100	0,21	mc. 0,0004

**15** x3-rete per schienale  
x3-net for back

code	finishing	q.kit	q.pack	a	b	kg.x1	vol.x1
132103-029	● nero/black	x1	50	400	460	0,14	mc. 0,0057

**16** vite trucciolare tsp\* d.3,5x10 brunita nera(per fissare schienale rete)  
shaving screw tsp\* d.3,5x10 zinc.(to fix mesh back)

code	finishing	q.kit
117803-105	● nero/black	x8

and · **09** **10** **11** **07**



# X3

swivel w/armrests



plastic colours

- grigio/gray ral 7003
- nero/black
- rosso/red 527
- bianco/white ral 1013

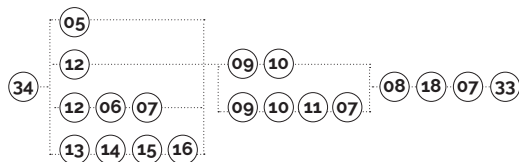

main component sizes

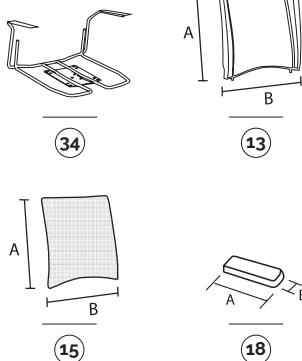

### 34 x3-telaio girevole a gas con braccioli

x3-swivel wire frame with arms d.12

code	finishing	q.kit	q.pack	kg.x1	vol.x1
110903-027	● nero/black	x1	100	4,00	mc. 0,02
110904-015	● grigio/gray	x1	100	4,00	mc. 0,02
110910-015	● cromato/chrome	x1	100	4,00	mc. 0,02

### 13 x3-schienale per rete nero a vista in plastica

x3-black plastic for mesh back

code	finishing	q.kit	q.pack	a	b	kg.x1	vol.x1
132103-014	● nero/black	x1	10	400	460	0,60	mc. 0,008

### 14 x3-liste a+b per schienale rete nere a vista

x3-black plastic strips a+b for mesh back

code	finishing	q.kit	q.pack	kg.x1	vol.x1
132103-013	● nero/black	x1	100	0,21	mc. 0,0004

### 15 x3-rete per schienale

x3-net for back

code	finishing	q.kit	q.pack	a	b	kg.x1	vol.x1
132103-029	● nero/black	x1	50	400	460	0,14	mc. 0,0057

### 16 vite trucciolare tsp+ d.3,5x10 brunita nera(per fissare schienale rete)

shaving screw tsp+ d.3,5x10 zinc.(to fix mesh back)

code	finishing	q.kit
117803-105	● nero/black	x8

### 18 x3-bracciolo plastica colorato per telaio filo

x3-colored plastic arm for wire frame

code	finishing	q.kit	q.pack	a	b	kg.x1	vol.x1
131703-019	● nero/black	x2	40	175	55	0,10	mc. 0,0004

### 07 vite hilo tb+ 5x12 cementata brunita nera

screw tb+fr.hilo 5x12 black burnished

code	finishing	q.kit seat	q.kit back
117803-154	● nero/black	x8	x6

for the components below, see page 86

33 08 09 10



for all colour codes, see page 93

# X3

## swivel w/armrests/backrest and seat options

main component sizes

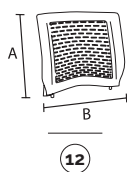

**12** x3-schienale colorato a vista in plastica forato  
x3-colored plastic back with holes

code	finishing	q.kit	q.pack	a	b	kg.x1	vol.x1
132104-019	● grigio/gray ral 7003	x1	10	400	460	0,90	mc. 0,008

and · **09** **10**

main component sizes

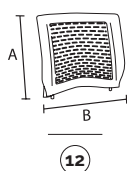

**12** x3-schienale colorato a vista in plastica forato  
x3-colored plastic back with holes

code	finishing	q.kit	q.pack	a	b	kg.x1	vol.x1
132105-019	○ bianco/white ral 1013	x1	10	400	460	0,90	mc. 0,008

**06** x3-pannello schienale da tappezzare in plastica  
x3-back panel for upholstery

code	finishing	q.kit	q.pack	a	b	kg.x1	vol.x1
132103-008	● nero/black	x1	20	350	385	0,50	mc. 0,003

**11** x3-pannello sedile da tappezzare in plastica  
x3-seat panel for upholstery

code	finishing	q.kit	q.pack	a	b	kg.x1	vol.x1
132203-003	● nero/black	x1	20	400	410	0,60	mc. 0,003

**07** vite hilo tb+ 5x12 cementata brunita nera  
screw tb+fr.hilo 5x12 black burnished

code	finishing	q.kit seat	q.kit back
117803-154	● nero/black	x8	x6

and · **09** **10**

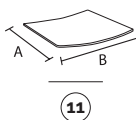
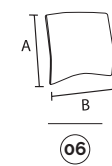

# X3 bench

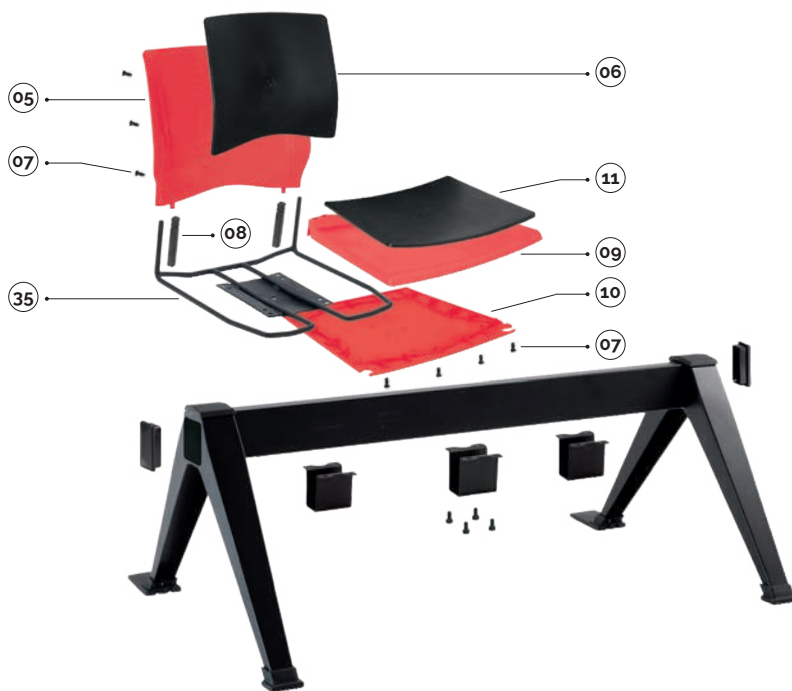

plastic colours

- grigio/gray ral 7003
- nero/black
- rosso/red 527
- bianco/white ral 1013

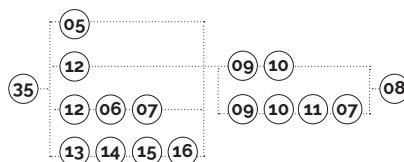

main component sizes

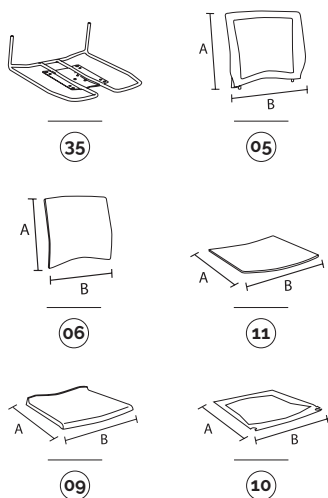

### 35 x3-telaio per panca x3-bench wire frame d.12

code	finishing	q.kit	q.pack	kg.x1	vol.x1
110703-041	● nero/black	x1	100	2,70	mc. 0,02
110704-039	● grigio/gray	x1	100	2,70	mc. 0,02

### 05 x3-schienale colorato a vista in plastica pieno x3-colored full plastic back

code	finishing	q.kit	q.pack	a	b	kg.x1	vol.x1
132102-090	● rosso/red 527	x1	10	400	460	0,90	mc. 0,008

### 06 x3-pannello schienale da tappezzare in plastica x3-plastic panel for upholstery

code	finishing	q.kit	q.pack	a	b	kg.x1	vol.x1
132103-008	● nero/black	x1	20	350	385	0,50	mc. 0,003

### 07 vite hilo tb\* 5x12 cementata brunita nera screw tb+fr.hilo 5x12 black burnished

code	finishing	q.kit seat	q.kit back
117803-154	● nero/black	x8	x6

### 08 x3-riduttore per schienale in plastica x3-plastic adapter for the back

code	finishing	q.kit	q.pack	kg.x1	vol.x1
132103-009	● nero/black	x2	200	0,019	mc. 0,0001

### 09 x3-sedile colorato a vista in plastica per telaio slitta x3-colored plastic seat for wire frame

code	finishing	q.kit	q.pack	a	b	kg.x1	vol.x1
132202-019	● rosso/red 527	x1	10	450	460	1,20	mc. 0,015

### 10 x3-sottosedile colorato a vista in plastica x3-outer colored plastic seat

code	finishing	q.kit	q.pack	a	b	kg.x1	vol.x1
132202-009	● rosso/red 527	x1	20	450	460	0,73	mc. 0,007

### 11 x3-pannello sedile da tappezzare in plastica x3-seat panel for upholstery

code	finishing	q.kit	q.pack	a	b	kg.x1	vol.x1
132203-003	● nero/black	x1	20	400	410	0,60	mc. 0,003

for the bench components, see page 201



for all colour codes, see page 93

# X3

bench w/armrests

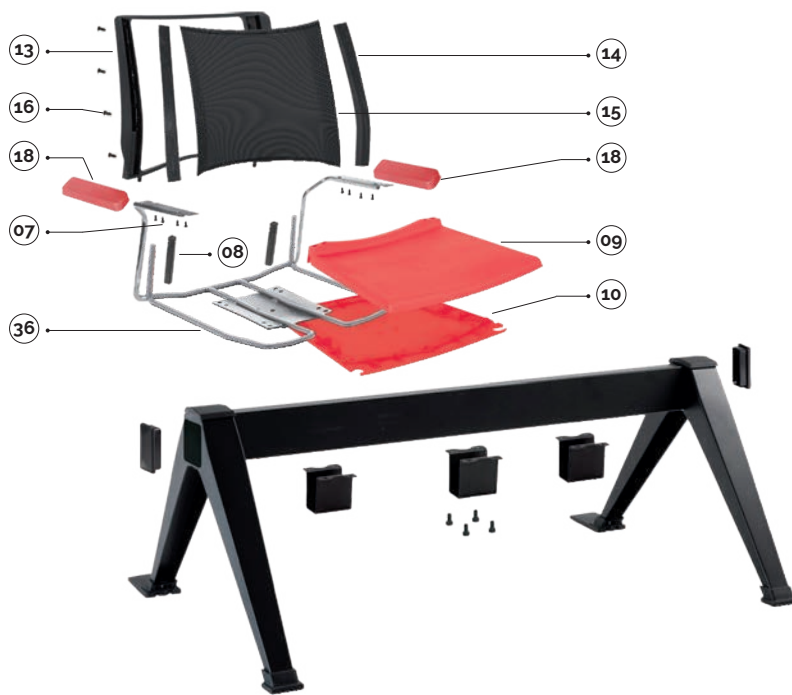

plastic colours

- grigio/gray ral 7003
- nero/black
- rosso/red 527
- bianco/white ral 1013

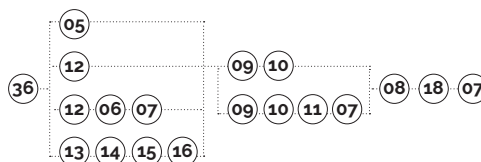

main component sizes

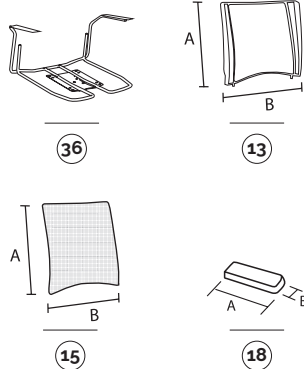

for the components below, see page 90

08 09 10

for all colour codes, see page 93

**36** x3-telaio per panca con braccioli  
x3-bench wire frame d.12 with arms

code	finishing	q.kit	q.pack	kg.x1	vol.x1
110703-044	● nero/black	x1	100	3,60	mc. 0,02
110704-210	● grigio/gray	x1	100	3,60	mc. 0,02
110710-044	● cromato/chrome	x1	100	3,60	mc. 0,02

**13** x3-schienale per rete nero a vista in plastica  
x3-black plastic for mesh back

code	finishing	q.kit	q.pack	a	b	kg.x1	vol.x1
132103-014	● nero/black	x1	10	400	460	0,60	mc. 0,008

**14** x3-liste a+b per schienale rete nere a vista  
x3-black plastic strips a+b for mesh back

code	finishing	q.kit	q.pack	kg.x1	vol.x1
132103-013	● nero/black	x1	100	0,21	mc. 0,0004

**15** x3-rete per schienale  
x3-net for back

code	finishing	q.kit	q.pack	a	b	kg.x1	vol.x1
132103-029	● nero/black	x1	50	400	460	0,14	mc. 0,0057

**16** vite truccolare tsp+ d.3,5x10 brunita nera(per fissare schienale rete)  
shaving screw tsp+ d.3,5x10 zinc.(to fix mesh back)

code	finishing	q.kit
117803-105	● nero/black	x8

**18** x3-bracciolo plastica colorato per telaio filo  
x3-colored plastic arm for wire frame

code	finishing	q.kit	q.pack	a	b	kg.x1	vol.x1
131702-019	● rosso/red 527	x2	40	175	55	0,10	mc. 0,0004

**07** vite hilo tb+ 5x12 cementata brunita nera  
screw tb+fr.hilo 5x12 black burnished

code	finishing	q.kit seat	q.kit back
117803-154	● nero/black	x8	x6

optionals

OPTIONAL bench connector

E-USB NEW bench plug

JIM NEW bench leg

APOLL bench arm

90GM bench leg

90GF bench leg

100GM bench leg

200GM bench leg

PIONEER bench arm

CUT bench leg

SLIM bench leg

CUT bench arm

SLIM bench arm



plastic

metal

aluminium

# X3

## bench w/armrests/backrest and seat options

main component sizes

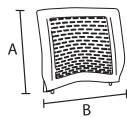

12

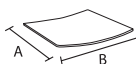

11



12 x3-schienale colorato a vista in plastica forato  
x3-colored plastic back with holes

code	finishing	q.kit	q.pack	a	b	kg.x1	vol.x1
132104-019	● grigio/gray ral 7003	x1	10	400	460	0,90	mc. 0,008

11 x3-pannello sedile da tappezzare in plastica  
x3-seat panel for upholstery

code	finishing	q.kit	q.pack	a	b	kg.x1	vol.x1
132203-003	● nero/black	x1	20	400	410	0,60	mc. 0,003

07 vite hilo tb+ 5x12 cementata brunita nera  
screw tb+fr.hilo 5x12 black burnished

code	finishing	q.kit seat	q.kit back
117803-154	● nero/black	x8	x6

and - 09 10

main component sizes

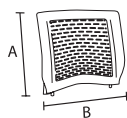

12

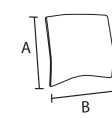

06

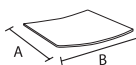

11



12 x3-schienale colorato a vista in plastica forato  
x3-colored plastic back with holes

code	finishing	q.kit	q.pack	a	b	kg.x1	vol.x1
132105-019	○ bianco/white ral 1013	x1	10	400	460	0,90	mc. 0,008

06 x3-pannello schienale da tappezzare in plastica  
x3-back panel for upholstery

code	finishing	q.kit	q.pack	a	b	kg.x1	vol.x1
132103-008	● nero/black	x1	20	350	385	0,50	mc. 0,003

11 x3-pannello sedile da tappezzare in plastica  
x3-seat panel for upholstery

code	finishing	q.kit	q.pack	a	b	kg.x1	vol.x1
132203-003	● nero/black	x1	20	400	410	0,60	mc. 0,003

07 vite hilo tb+ 5x12 cementata brunita nera  
screw tb+fr.hilo 5x12 black burnished

code	finishing	q.kit seat	q.kit back
117803-154	● nero/black	x8	x6

and - 09 10

# X3

## optional colour codes



### plastic colour codes



**12** schienale in plastica con fori  
plastic backrest with holes

- 132104-019 grigio/gray ral 7003
- 132103-019 nero/black
- 132102-019 rosso/red 527
- 132105-019 bianco/white ral 1013



**05** schienale in plastica pieno  
full plastic backrest

- 132104-090 grigio/gray ral 7003
- 132103-090 nero/black
- 132102-090 rosso/red 527
- 132105-090 bianco/white ral 1013



**09** sedile in plastica per telaio slitta  
plastic seat for wire frame

- 132204-019 grigio/gray ral 7003
- 132203-019 nero/black
- 132202-019 rosso/red 527
- 132205-019 bianco/white ral 1013



**26** sedile in plastica per telaio 4 gambe  
plastic seat for 4-legs frame

- 132204-018 grigio/gray ral 7003
- 132203-018 nero/black
- 132202-018 rosso/red 527
- 132205-018 bianco/white ral 1013

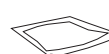

**10** sottosedile in plastica  
outer plastic seat

- 132204-009 grigio/gray ral 7003
- 132203-009 nero/black
- 132202-009 rosso/red 527
- 132205-009 bianco/white ral 1013



**18** bracciolo in plastica per telaio slitta  
plastic arm for wire frame

- 131704-019 grigio/gray ral 7003
- 131703-019 nero/black
- 131702-019 rosso/red 527
- 131705-019 bianco/white ral 1013



**20** bracciolo in plastica per telaio slitta con tavoletta  
plastic arm for wire frame with tablet

- 131704-018 grigio/gray ral 7003
- 131703-018 nero/black
- 131702-018 rosso/red 527
- 131705-018 bianco/white ral 1013



**28** bracciolo in plastica per telaio 4 gambe  
plastic arm for 4-legs frame

- 131704-017 grigio/gray ral 7003
- 131703-017 nero/black
- 131702-017 rosso/red 527
- 131705-017 bianco/white ral 1013



**30** bracciolo in plastica per telaio 4 gambe con tavoletta  
plastic arm for 4-legs frame with tablet

- 131704-014 grigio/gray ral 7003
- 131703-014 nero/black
- 131702-014 rosso/red 527
- 131705-014 bianco/white ral 1013







BEYOND | **Logistic**





**pull**



# pull



---

side

4 legs

swivel

bench

## pull showing

---

### features



trolley  
available



Una seduta dal **disegno moderno e accattivante**, con monoscocca in plastica disponibile in vari colori.

È ideale per i diversi **ambienti Community**, in cui siano richieste **impilabilità, leggerezza e semplicità di utilizzo**: dal **Contract**, alle **aree d'attesa**, fino al **settore formation**.

Oltre alle versioni 4 gambe e a slitta, prevede le versioni girevole e panca.

*Chair with a **modern and attractive design**, featuring a monocoque plastic seat available in a range of colours.*

*Ideal for different **Community environments**, where **stackability, lightness and ease of use** are required: from **Contract**, to **waiting areas**, to the **training sector**.*

*In addition to the 4-legged and sled versions, it is also available in swivel and bench versions.*

# pull

## slide

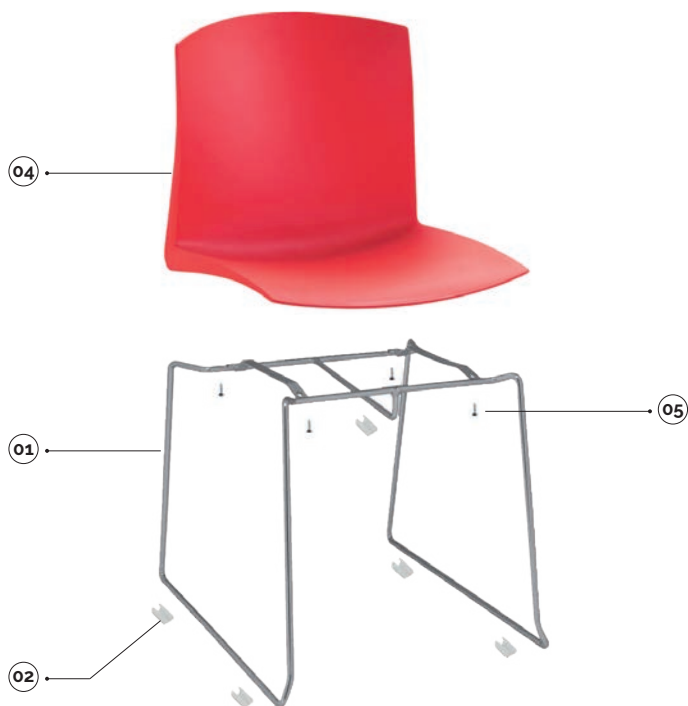

plastic colours

- grigio/grey ral 7035
- nero/black
- arancio/orange ral 2003
- bianco/white 218
- rosso/red 527

main component sizes

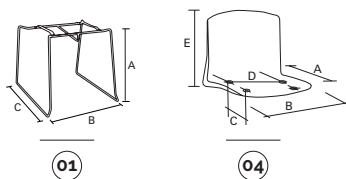

optional

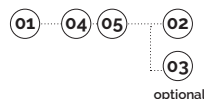
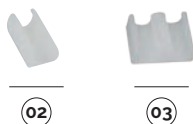

### 01 speedy-sgabello in tondino per scocca modello pull speedy-round bar for the shell mod.pull

code	finishing	q.kit	q.pack	a	b	c	kg.x1	vol.x1
113410-025	● cromato/chrome	x1	120	450	580	570	3,05	mc. 0,04

### 02 confezione di basi a pinza antirotazione per tondino colore neutro neutral clips base for wire d.11 package

code	finishing	q.kit	q.pack
137006-070	○ neutro/neutral	x4	200

### 03 base piana a pinza doppia in pe per tondo per unione sedie double flat clip base for tube

code	finishing	q.kit
134006-021	○ neutro/neutral	x4

### 04 pull-scocca intera modello pull pull-shell mod. pull

code	finishing	q.kit	q.pack	a	b	c	d	e	kg.x1	vol.x1
133902-026	● rosso/red 527	x1	10	520	450	255	315	393	1,60	mc. 0,021

### 05 vite tc+combi 6x16 testa cilindrica a croce zincata (vite fissaggio scocca) screw combi 6x16 cylindrical head cross zinc (screw for fix shell)

code	finishing	q.kit
117811-181	○ zincata/zinc	x4

### speedy-carrello portasedie con accessori nero speedy-trolley for chairs with accessories black

code	finishing
110803-358	● nero/black



for all colour codes, see page 101

# pull

## 4-legs



plastic colours

- grigio/grey ral 7035
- nero/black
- arancio/orange ral 2003
- bianco/white 218
- rosso/red 527

main component sizes

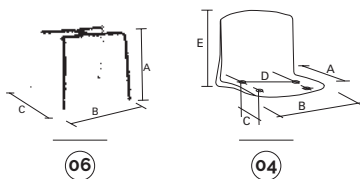

optional

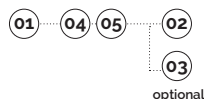

### 06 pull-sgabello in tubo d.18 per scocca pull-stool tube d.18 for shell

code	finishing	q.kit	q.pack	a	b	c	kg.x1	vol.x1
110603-075	● nero/black	x1	200	450	470	490	2,00	mc. 0,02
110604-095	● grigio/grey	x1	200	450	470	490	2,00	mc. 0,02
110610-045	● cromato/chrome	x1	200	450	470	490	2,00	mc. 0,02

### 07 confezione puntali tondi d.18 neri black inner round caps d.18 package

code	finishing	q.kit	q.pack
137003-072	● nero/black	x4	200

### 08 confezione viti hilo 5,5x30 testa svasata a croce zincata (vite per fissaggio scocca) cross screws hilo d.5x30 flared zinc (screw for shell fixing) package

code	finishing	q.kit	q.pack
117011-071	○ zincata/zinc	x4	200

### 04 pull-scocca intera modello pull pull-shell mod. pull

code	finishing	q.kit	q.pack	a	b	c	d	e	kg.x1	vol.x1
133903-025	● nero/black	x1	10	520	450	255	315	393	1,60	mc. 0,021

### 09 supporto per impilabilita' scocca neutro support for shell stackability neutral

code	finishing	q.kit	kg.x1
134006-030	○ neutro/neutral	x1	0,025

### 10 vite hilo tb 5x14 nera hilo cross screw tb 5x14 black

code	finishing	q.kit
117803-155	● nero/black	x1

### pull-carrello portasedie con accessori nero pull-trolley for chairs with accessories black

code	finishing
110803-347	● nero/black



for all colour codes, see page 101



# pull swivel



plastic colours

- grigio/grey ral 7035
- nero/black
- arancio/orange ral 2003
- bianco/white 218
- rosso/red 527

main component sizes

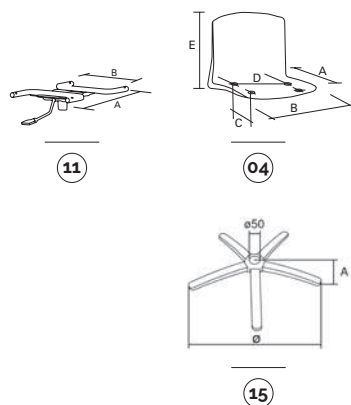

options

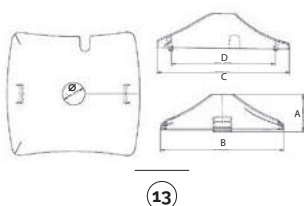

11 04 08 12 13 15  
optional

**11** supporto girevole a gas per scocca pull  
swivel metal frame for gas lift for pull shell

code	finishing	q.kit	q.pack	a	b	kg.x1	vol.x1
110903-025	● nero/black	x1	10	315	255	1.40	mc. 0.004

**12** confezione tappi copristesta d.18 neri  
black cover head caps d.18 package

code	finishing	q.kit	q.pack
137003-070	● nero/black	x4	200

**04** pull-scocca intera modello pull  
pull-shell mod. pull

code	finishing	q.kit	q.pack	a	b	c	d	e	kg.x1	vol.x1
133907-025	● arancio/orange ral 2003	x1	10	520	450	255	315	393	1.60	mc. 0.021

**08** confezione viti hilo 5,5x30 testa svasata a croce zincata (vite per fissaggio scocca)  
cross screws hilo d.5x30 flared zinc (screw for shell fixing) package

code	finishing	q.kit	q.pack
117011-071	○ zincata/zinc	x4	200

**13** cpg-copertina in plastica per telaio girevole  
cpg-plastic cover for swivel frame

code	finishing	q.kit	q.pack	a	b	c	d	ø	kg.x1	vol.x1
130903-000	● nero/black	x1	50	60	200	210	167	36	0.1	mc. 0.0015

**15** b40 base in metallo d.640 con coprisaldatura  
b40 metal base d.640 with cover welding

code	finishing	q.kit	q.pack	a	ø	kg.x1	vol.x1
110210-027	● cromato/chrome	x1	5	60	640	2.85	mc. 0.014

CPG  
plastic cover for swivel frame



for all colour codes, see page 101

# pull

## bench



plastic colours

- grigio/grey ral 7035
- nero/black
- arancio/orange ral 2003
- bianco/white 218
- rosso/red 527

14 04 08 12

main component sizes

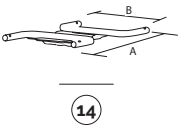

14 supporto per attacco scocca pull su panca  
bench frame for pull shell

code	finishing	q.kit	q.pack	a	b	kg.x1	vol.x1
110703-085	● nero/black	x1	10	315	255	1.40	mc. 0.004

for the components below, see page 100

for all colour codes, see below

12 04 08

for the bench components, see page 201

optional

OPTIONAL  
bench  
connector

E-USB NEW  
bench plug



JIM NEW  
bench leg

APOLL  
bench arm



plastic

90GM  
bench leg

90GF  
bench leg

100GM  
bench leg

200GM  
bench leg

PIONEER  
bench arm



metal

CUT  
bench leg

SLIM  
bench leg

CUT  
bench arm

SLIM  
bench arm



aluminium

# pull

## optional colour codes



### shell colour codes

04 scocche in plastica  
plastic shells

- 133904-026 grigio/grey ral 7035
- 133903-025 nero/black
- 133907-025 arancio/orange ral 2003
- 133905-026 bianco/white 218
- 133902-026 rosso/red 527



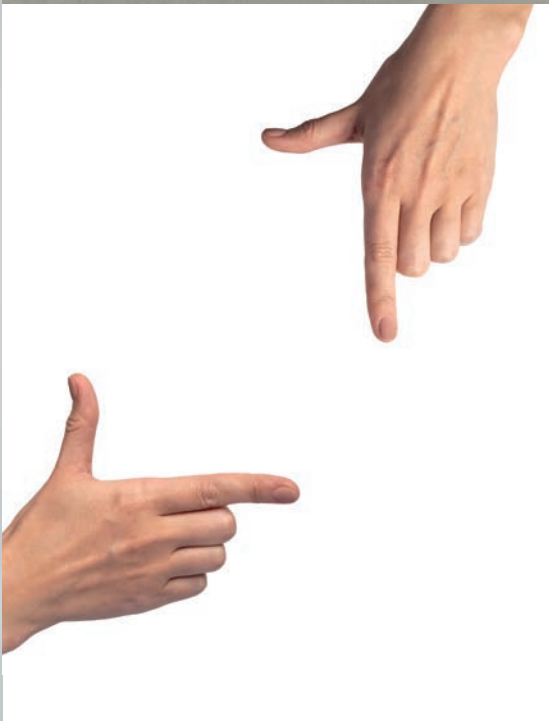
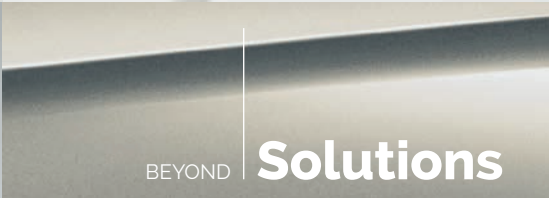



**q5**



# q5



---

slide

4 legs

swivel

bench

slide w/writing tablet

stool



BIFMA TEST

only for 2 mm thickness  
4-legs special frame



BIFMA TEST

tools



certification

q5 showing



Una seduta caratterizzata da una **linea elegante** e da **dettagli distintivi**, perfetta espressione del design italiano.

La scocca disponibile in **4 moderni colori** può essere abbinata a una serie completa di telai e accessori che rendono **Q5** la soluzione ideale per ambienti diversi: dall'**Home** al **Contract**, fino alle **aree formation**, anche grazie alla sua pratica **impilabilità**.

*A seat characterized by **elegant lines** and **distinctive detailing** representing a perfect expression of Italian design.*

*The shell is available in **4 modern colours** which can be combined with a complete series of frames and accessories. This makes **Q5** the ideal solution for different environments: from **Home** to **Contract**, and also **training settings**, thanks also to its practical **stackability**.*



# q5

## slide

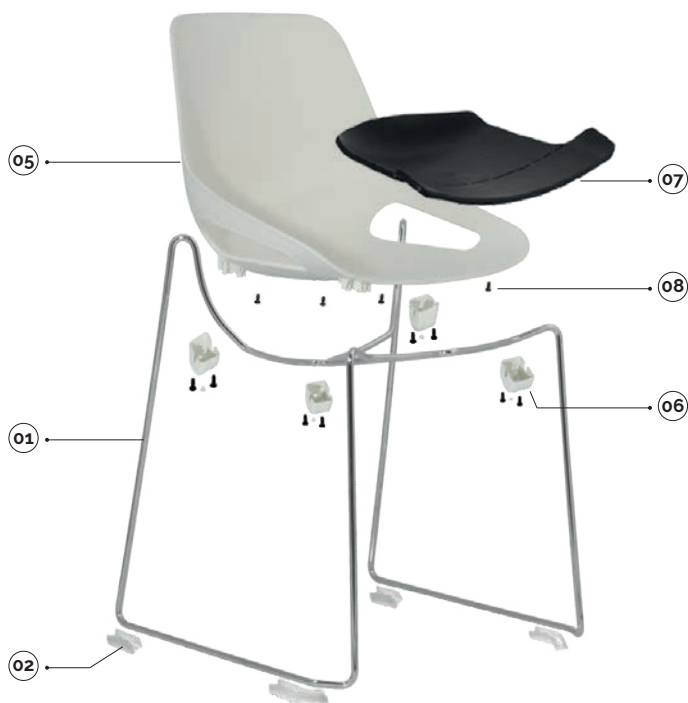

plastic colours

- marrone/brown ral8022
- avorio/ivory ral1013
- giallo/yellow ral1012
- grigio/grey ral7003

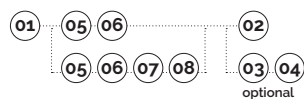

main component sizes

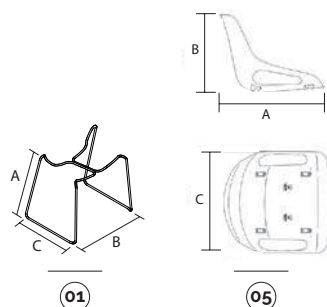

01

05

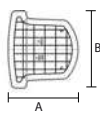

07

optional

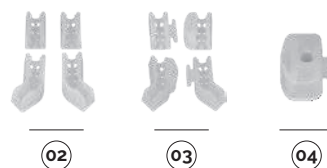

02

03

04

### 01 q5-telaio slitta in tondino per scocca senza tappi

q5-slide wire frame for shell without caps

code	finishing	q.kit	q.pack	a	b	c	kg.x1	vol.x1
113410-012	● cromato/chrome	x1	100	450	550	510	4,00	mc. 0,04

### 02 btf-kit piedini

btf-kit feet

code	finishing	q.kit	q.pack	kg.x1
134306-001	○ neutro/neutral	x1	100	0,05

### 03 btf-a-kit piedini con ganci

btf-a-kit feet with hooks

code	finishing	q.kit	q.pack	kg.x1
134306-002	○ neutro/neutral	x1	100	0,06

### 04 pptf-tappo per fissaggio pavimento

pptf-cap for fixing to the floor

code	finishing	q.kit	q.pack	kg.x1
134306-003	○ neutro/neutral	x2	100	0,03

### 05 q5-scozza intera modello q5

q5-shell model q5

code	finishing	q.kit	q.pack	a	b	c	kg.x1	vol.x1
133905-035	○ avorio/ivory ral1013	x1	10	400	400	470	1,60	mc. 0,02

### 06 q5-confezione accessori per scocca q5

q5-packaging accessories for shell q5

code	finishing	q.kit	q.pack	kg.x1	vol.x1
137005-004	○ avorio/ivory ral1013	x1	10	telaio in tondino/wire frame	0,085 mc. 0,00

### 07 q5-pannello sedile da tappezzare

q5-panel back for upholstery

code	finishing	q.kit	q.pack	a	b	kg.x1	vol.x1
132203-048	● nero/black	x1	20	390	420	0,52	mc. 0,003

### 08 confezione viti tbl+ fr. d.5x14 per pannello da tappezzare

screws tbl+ fr.hilo d.5x14 zinc.black (to fix seat panel) package

code	finishing	q.kit	q.pack
117003-071	● nero/black	x4	200



for all colour codes, see page 113

# q5

slide w/writing tablet

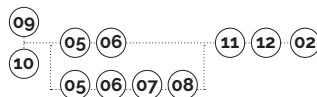
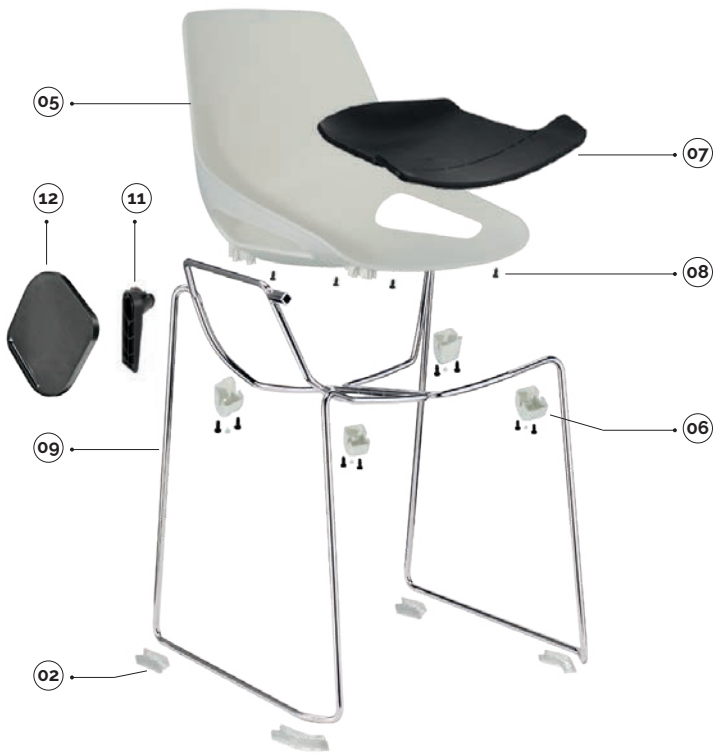

plastic colours

- marrone/brown ral8022
- avorio/ivory ral1013
- giallo/yellow ral1012
- grigio/grey ral7003

main component sizes

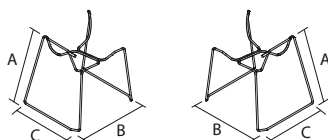

09

10



11

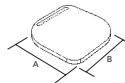

12

**09** q5-telaio slitta in tondino per scocca con porta tavoletta destro senza tappi  
q5-slide wire frame for shell with right tablet hook without caps

code	finishing	hook	q.kit	q.pack	a	b	c	kg.x1	vol.x1
113410-013	● cromato/chrome	destro/right	x1	50	450	550	510	4,65	mc. 0.057

**10** q5-telaio slitta in tondino per scocca con porta tavoletta sinistro senza tappi  
q5-slide wire frame for shell with left tablet hook without caps

code	finishing	hook	q.kit	q.pack	a	b	c	kg.x1	vol.x1
113410-017	● cromato/chrome	sinistro/left	x1	50	450	550	510	4,65	mc. 0.057

**11** spt2-snodo per tavoletta in termoplastica  
spt2-thermoplastic writing tablet articulation

code	finishing	q.kit	q.pack	a	b	c	kg.x1	vol.x1
134003-039	● nero/black	x1	20	180	66	15x15	0,35	mc. 0.0006

**12** tl2-tavoletta in termoplastico ovale spessore 16 mm per bracciolo destro e sinistro  
tl2-writing tablet in oval plastic thickness 16 mm for left and right arms

code	finishing	q.kit	q.pack	a	b	kg.x1	vol.x1
134003-040	● nero/black	x1	20	271	271	0,40	mc. 0.002

for the components below, see page 106



for all colour codes, see page 113

02 05 06 07 08



TLT  
tablet

TLT2  
tablet

TLT3  
tablet

BEAN  
tablet

TL02  
tablet

SPT2  
mechanism tablet

SPTA  
mechanism antipanic



for writing tablet options, see page 192/193

# q5 stool

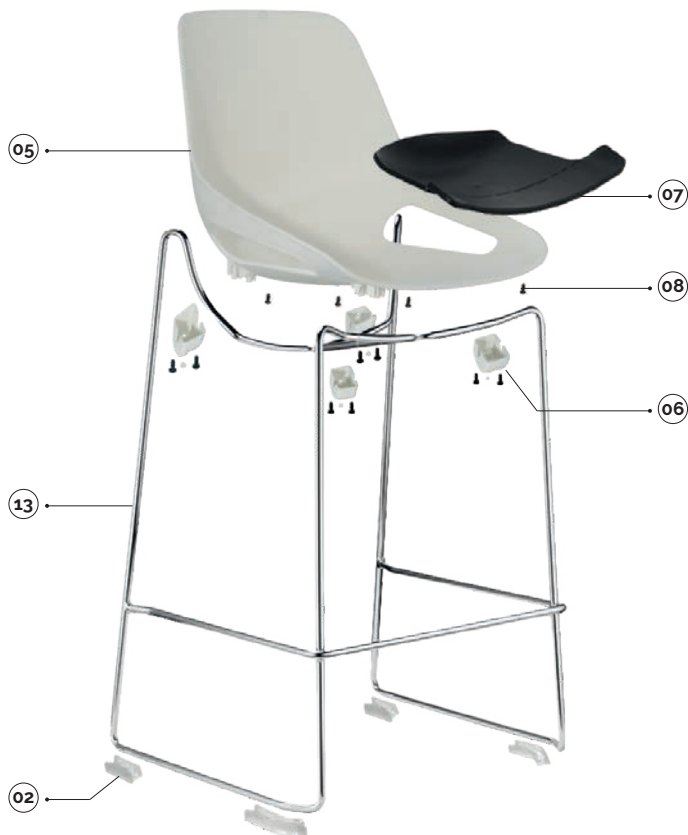

plastic colours

- marrone/brown ral8022
- avorio/ivory ral1013
- giallo/yellow ral1012
- grigio/grey ral7003

main component sizes

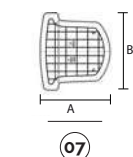
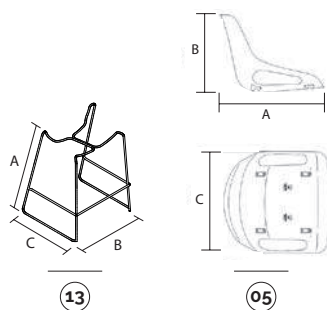

optional

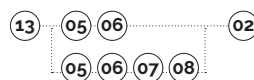

### 13 q5-sgabello alto in tondino per scocca senza tappi q5-wired frame tall stool for shell without caps

code	finishing	q.kit	q.pack	a	b	c	kg.x1	vol.x1
113410-006	● cromato/chrome	x1	50	700	550	510	6,30	mc. 0,08

### 02 btf-kit piedini btf-kit feet

code	finishing	q.kit	q.pack	kg.x1
134306-001	○ neutro/neutral	x1	100	0,05

### 05 q5-scocca intera modello q5 q5-shell model q5

code	finishing	q.kit	q.pack	a	b	c	kg.x1	vol.x1
133905-035	○ avorio/ivory ral1013	x1	10	400	400	470	1,60	mc. 0,02

### 06 q5-confezione accessori per scocca q5 q5-packaging accessories for shell q5

code	finishing	q.kit	q.pack	kg.x1	vol.x1
137005-004	○ avorio/ivory ral1013	x1	10	telaio in tondino/wire frame	0,085 mc. 0,00

### 07 q5-pannello sedile da tappezzare q5-panel back for upholstery

code	finishing	q.kit	q.pack	a	b	kg.x1	vol.x1
132203-048	● nero/black	x1	20	390	420	0,52	mc. 0,003

### 08 confezione viti tbl+ fr. d.5x14 per pannello da tappezzare screws tbl+ fr.hilo d.5x14 zinc.black (to fix seat panel) package

code	finishing	q.kit	q.pack
117003-071	● nero/black	x4	200



for all colour codes, see page 113

# q5

## 4-legs



CERTIFIED BY  
**BIFMA**



plastic colours

- marrone/brown ral8022
- avorio/ivory ral1013
- giallo/yellow ral1012
- grigio/grey ral7003



main component sizes

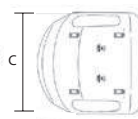
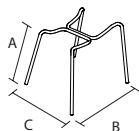
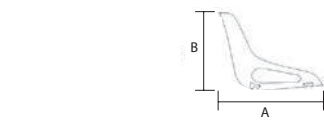

14

05

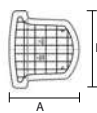

07

optional



17

### 14 q5-telaio 4 gambe in tubo d.18 senza tappi

q5-4 legs frames d.18 without caps

code	finishing	q.kit	q.pack	a	b	c	kg.x1	vol.x1
110603-022	● nero/black	x1	200	450	460	480	1,70	mc. 0,02
110604-022	● grigio/grey	x1	200	450	460	480	1,70	mc. 0,02
110610-135	● cromato/chrome	x1	200	450	460	480	1,70	mc. 0,02

### 15 confezione puntali tondi d.18 neri

black inner round caps d.18 package

code	finishing	q.kit	q.pack
137003-072	● nero/black	x4	200

### 05 q5-scozza intera modello q5

q5-shell model q5

code	finishing	q.kit	q.pack	a	b	c	kg.x1	vol.x1
133903-035	● marrone/brown ral8022	x1	10	400	400	470	1,60	mc. 0,02

### 16 q5-confezione accessori per scozza q5

q5-packaging accessories for shell q5

code	finishing	q.kit	q.pack	kg.x1	vol.x1
137003-003	● marrone/brown ral8022	x1	10	telaio tubo/tube frame	0,085 mc. 0,00

### 07 q5-pannello sedile da tappezzare

q5-panel back for upholstery

code	finishing	q.kit	q.pack	a	b	kg.x1	vol.x1
132203-048	● nero/black	x1	20	390	420	0,52	mc. 0,003

### 08 confezione viti tbl+ fr. d.5x14 per pannello da tappezzare

screws tbl+ fr.hilo d.5x14 zinc.black (to fix seat panel) package

code	finishing	q.kit	q.pack
117003-071	● nero/black	x4	200

### 17 q5-coppia aggancio laterale in tondino + plastica nera

q5-couple round bar lateral hook + black plastic

code	finishing	q.kit	q.pack	kg.x1	vol.x1
113410-004	● cromato/chrome	x1	50	0,15	mc. 0,0004



for all colour codes, see page 113

# q5 swivel



plastic colours

- marrone/brown ral8022
- avorio/ivory ral1013
- giallo/yellow ral1012
- grigio/grey ral7003

main component sizes

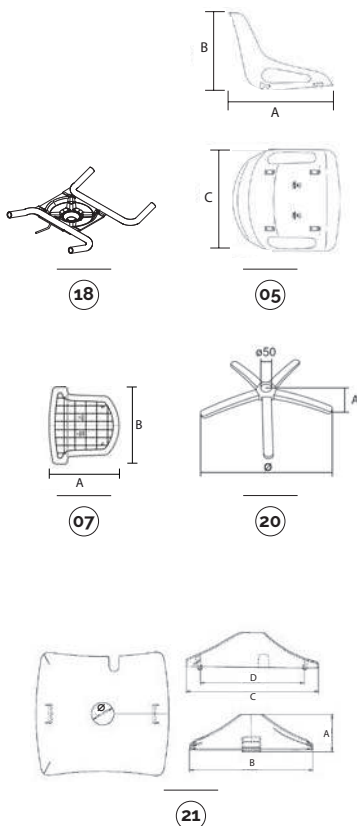

optionals

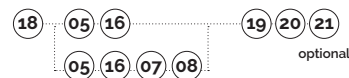

## 18 q5-supporto girevole a gas per scocca q5 q5-gas lift swivel wire frame for shell without caps

code	finishing	q.kit	q.pack	kg.x1	vol.x1
110903-012	● nero/black	x1	10	1,50	mc. 0,004
110904-012	● grigio/grey	x1	10	1,50	mc. 0,004

## 19 confezione tappi copritesta d.18 neri black cover head caps d.18 package

code	finishing	q.kit	q.pack
137003-070	● nero/black	x1	200

## 05 q5-scozza intera modello q5 q5-shell model q5

code	finishing	q.kit	q.pack	a	b	c	kg.x1	vol.x1
133905-035	○ avorio/ivory ral1013	x1	10	400	400	470	1,60	mc. 0,02

## 16 q5-confezione accessori per scocca q5 q5-packaging accessories for shell q5

code	finishing	q.kit	q.pack	kg.x1	vol.x1
137005-003	○ avorio/ivory ral1013	x1	10	telaio tubo/tube frame	0,085 mc. 0,00

## 07 q5-pannello sedile da tappezzare q5-panel back for upholstery

code	finishing	q.kit	q.pack	a	b	kg.x1	vol.x1
132203-048	● nero/black	x1	20	390	420	0,52	mc. 0,003

## 08 confezione viti tbl+ fr. d.5x14 per pannello da tappezzare screws tbl+ fr.hilo d.5x14 zinc.black (to fix seat panel) package

code	finishing	q.kit	q.pack
117003-071	● nero/black	x4	200

## 20 b40 base in metallo d.640 con coprisaldatura b40 metal base d.640 with cover welding

code	finishing	q.kit	q.pack	a	ø	kg.x1	vol.x1
110210-027	● cromato/chrome	x1	5	60	640	2,85	mc. 0,014

## 21 cpq-copertina in plastica per telaio girevole cpq-plastic cover for swivel frame

code	finishing	q.kit	q.pack	a	b	c	d	ø	kg.x1	vol.x1
130903-000	● nero/black	x1	50	60	200	210	167	36	0,1	mc. 0,0015

CPG  
plastic cover for swivel frame



for all colour codes, see page 113

# q5 bench



CERTIFIED BY  
**BIFMA**

plastic colours

- marrone/brown ral8022
- avorio/ivory ral1013
- giallo/yellow ral1012
- grigio/grey ral7003



**22** q5-supporto per attacco scocca q5 su panca  
q5-bench frame for q5 shell

code	finishing	q.kit	q.pack	kg.x1	vol.x1
110703-188	● nero/black	x1	10	1.40	mc. 0.004

main component sizes

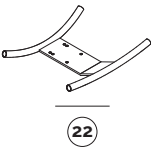

for the components below, see page 110



for all colour codes, see page 113

for the bench components, see page 201

optionals

OPTIONAL  
bench connector

E-USB **NEW**  
bench plug



JIM **NEW**  
bench leg

APOLL  
bench arm



plastic

90GM  
bench leg

90GF  
bench leg

100GM  
bench leg

200GM  
bench leg

PIONEER  
bench arm



metal

CUT  
bench leg

SLIM  
bench leg

CUT  
bench arm

SLIM  
bench arm



aluminium





# q5

optional colour codes



## shell colour codes



05 scocche in plastica  
plastic shells

- 133903-035 marrone/brown ral8022
- 133905-035 avorio/ivory ral1013
- 133908-035 giallo/yellow ral1012
- 133904-035 grigio/grey ral7003

## accessory colour codes



06 accessori in plastica per telaio in tondino  
plastic accessories for wire frame

- 137003-004 marrone/brown ral8022
- 137005-004 avorio/ivory ral1013
- 137008-004 giallo/yellow ral1012
- 137004-004 grigio/grey ral7003



16 accessori in plastica per telaio a tubo  
plastic accessories for tube frame

- 137003-003 marrone/brown ral8022
- 137005-003 avorio/ivory ral1013
- 137008-003 giallo/yellow ral1012
- 137004-003 grigio/grey ral7003



BEYOND | **Logistic**

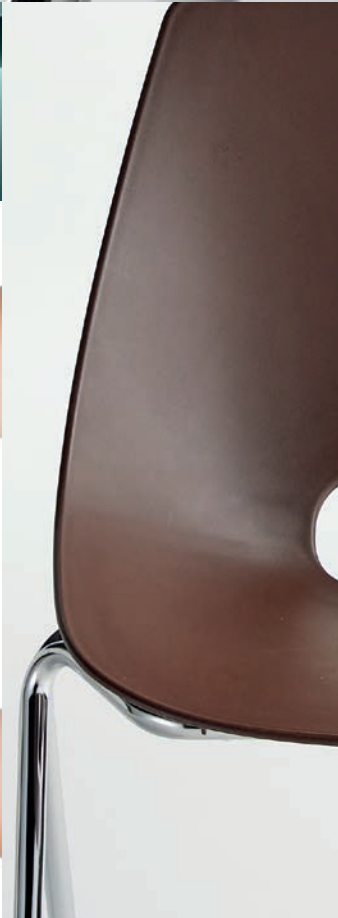



**oki**

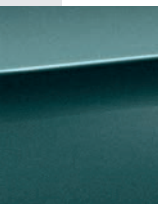

# oki



---

slide

4 legs

4 legs w/armrests

4 legs w/writing tablet

swivel

bench

oki showing

---



Una sedia dalla **monoscocca in plastica ampia, confortevole** e dai colori vivaci che, unitamente all'ampio foro centrale, le conferiscono un **look casual** e pratico. È inoltre impilabile e facile da pulire.

Con l'ampia gamma di telai previsti, disponibili in varie finiture, può adattarsi a diverse finalità **dall'Home all'Office**, fino alle **aree Community** grazie al telaio in tubo con aggancio laterale, ai braccioli e al porta tavoletta.

*A **large, comfortable monocoque plastic** chair available in range of bright colours which, together with the large central hole, go to create **casual and practical look**. It is also stackable and easy to clean.*

*With the wide range of frames available in a selection of finishes, it can be adapted to different contexts, ranging from **Home to Office**, and even **Community areas** thanks to the tubular frame with lateral hooks, armrests, and writing tablet holder.*

# oki

## slide

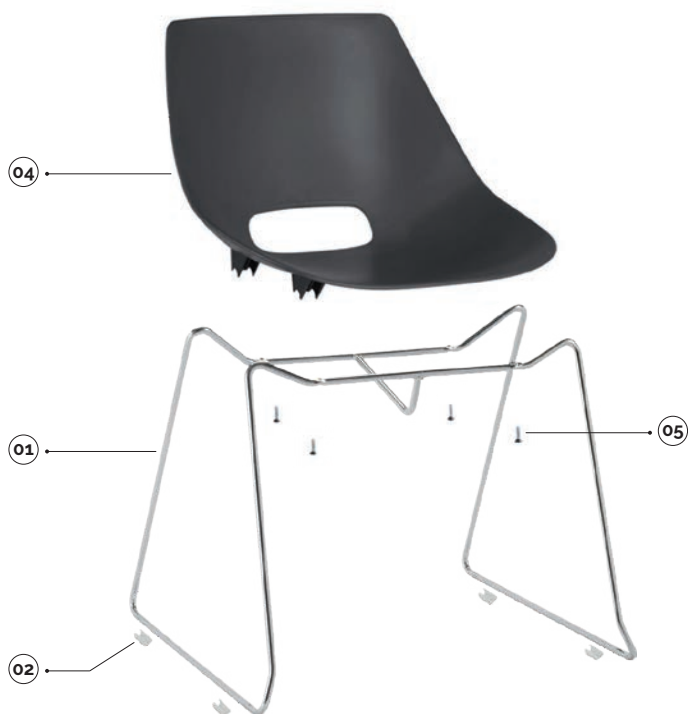

plastic colours

- nero/black
- bianco/white 218
- blu/blue 5002

main component sizes

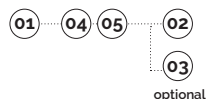
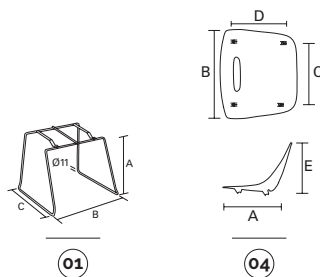

**01** oki-sgabello in tondino per scocca cromato senza tappi  
oki-stool in chrome frame wire for shell without caps

code	finishing	q.kit	q.pack	a	b	c	kg.x1	vol.x1
113410-008	● cromato/chrome	x1	50	450	600	550	3,30	mc. 0,04

**02** confezione di basi a pinza antirotazione per tondino colore neutro  
neutral clips base for wire d.11 package

code	finishing	q.kit	q.pack
137006-070	○ neutro/neutral	x4	200

**03** base piana a pinza doppia in pe per tondo per unione sedie  
double flat clip base for tube

code	finishing	q.kit
134006-021	○ neutro/neutral	x4

**04** oki-scocca intera modello oki  
oki-shell for oki model

code	finishing	q.kit	q.pack	a	b	c	d	e	kg.x1	vol.x1
133903-050	● nero/black	x1	10	525	530	209	306	395	1,80	mc. 0,025

**05** vite autoflettante 5,5x19 testa cilindrica a croce zincata (vite fissaggio scocca)  
auto-thread screw 5,5x19 cylindrical head cross zinc (screw for shell fixing)

code	finishing	q.kit
117811-180	○ zincata/zinc	x4

optional

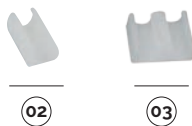

for all colour codes, see page 123



# oki

## 4-legs



plastic colours

- nero/black
- bianco/white 218
- blu/blue 5002

main component sizes

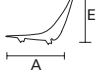
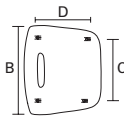
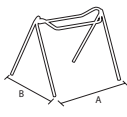

optipnats

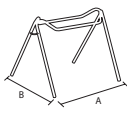

### 06 oki-sgabello 4 gambe in tubo d.18 senza tappi

oki-4 legs stool d.18 tube without caps

code	finishing	q.kit	q.pack	a	b	kg.x1	vol.x1
112703-090	● nero/black	x1	100	560	520	2,70	mc. 0,02
112704-090	● grigio/grey	x1	100	560	520	2,70	mc. 0,02
112710-090	● cromato/chrome	x1	100	560	520	2,70	mc. 0,02

### 07 tappi-puntale alettato testa sferica d.18 nero

inner caps-black spherical cap d.18

code	finishing	q.kit
134203-181	● nero/black	x4

### 08 confezione viti hilo d.5x35 testa svasata a croce zincate (vite fissaggio scocca)

screws auto-thread 5x35 flared cross head zinc for shell fixing package

code	finishing	q.kit	q.pack
117011-070	○ zincata/zinc	x4	200

### 04 oki-scocca intera modello oki

oki-shell for oki model

code	finishing	q.kit	q.pack	a	b	c	d	e	kg.x1	vol.x1
133905-050	○ bianco/white 218	x1	10	525	530	209	306	395	1,80	mc. 0,025

### 09 supporto per impilabilita' scocca oki neutro

support for stackability neutral shell oki

code	finishing	q.kit
134006-031	○ neutro/neutral	x1

### 10 oki-sgabello 4 gambe in tubo d.18 con aggancio laterale senza tappi

oki-4 legs stool d.18 tube with lateral hooks without caps

code	finishing	q.kit	q.pack	a	b	kg.x1	vol.x1
112703-091	● nero/black	x1	100	560	520	2,70	mc. 0,02
112704-091	● grigio/grey	x1	100	560	520	2,70	mc. 0,02
112710-091	● cromato/chrome	x1	100	560	520	2,70	mc. 0,02

frame optional  
4 legs stool d.18 tube with lateral hooks

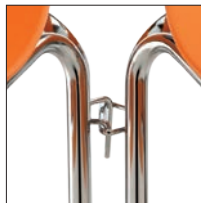

10



for all colour codes, see page 123

# oki

4-legs w/armrests



plastic colours

- nero/black
- bianco/white 218
- blu/blue 5002

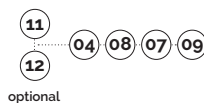

main component sizes

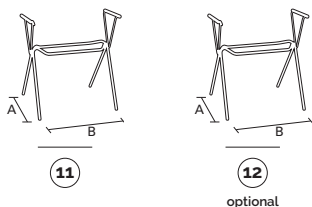

**11** oki-sgabello 4 gambe in tubo d.18 con braccioli senza tappi  
oki-4 legs stool with armrest d.18 tube without caps

code	finishing	q.kit	q.pack	a	b	kg.x1	vol.x1
112703-096	● nero/black	x1	50	560	520	4,00	mc. 0,05
112704-096	● grigio/grey	x1	50	560	520	4,00	mc. 0,05
112710-096	● cromato/chrome	x1	50	560	520	4,00	mc. 0,05

**12** oki-sgabello 4 gambe tubo d.18 con braccioli + aggancio portatavoletta senza tappi  
oki-4 legs stool with armrest d.18 tube without caps + hook for tablet

code	finishing	q.kit	q.pack	a	b	kg.x1	vol.x1
112703-098	● nero/black	x1	50	560	520	4,00	mc. 0,05
112704-098	● grigio/grey	x1	50	560	520	4,00	mc. 0,05
112710-098	● cromato/chrome	x1	50	560	520	4,00	mc. 0,05

for the components below, see page 119



for all colour codes, see page 123

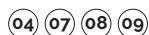

for writing tablet options, see page 192/193

# oki

## swivel



plastic colours

- nero/black
- bianco/white 218
- blu/blue 5002

main component sizes

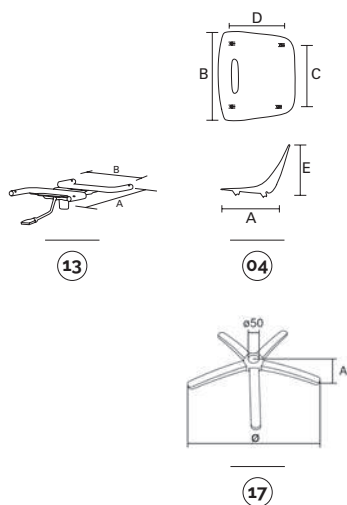

optipnats

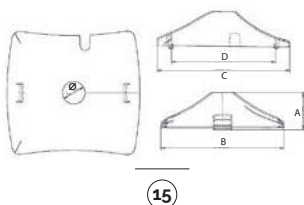

13 04 08 14 15 17  
optional

**13** oki-supporto girevole a gas per scocca oki  
oki-gas lift swivel metal frame for oki shell

code	finishing	q.kit	q.pack	a	b	kg.x1	vol.x1
110903-010	● nero/black	x1	10	306	209	1,30	mc. 0.04

**14** confezione tappi copritesta d.18 neri  
black cover head caps d.18 package

code	finishing	q.kit	q.pack
137003-070	● nero/black	x4	200

**04** oki-scocca intera modello oki  
oki-shell for oki model

code	finishing	q.kit	q.pack	a	b	c	d	e	kg.x1	vol.x1
133915-050	● blu/blue 5002	x1	10	525	530	209	306	395	1,80	mc. 0.025

**08** confezione viti hilo d.5x35 testa svasata a croce zincate (vite fissaggio scocca)  
screws auto-thread 5x35 flared cross head zinc for shell fixing package

code	finishing	q.kit	q.pack
117011-070	○ zincata/zinc	x4	200

**15** cpg-copertina in plastica per telaio girevole  
cpg-plastic cover for swivel frame

code	finishing	q.kit	q.pack	a	b	c	d	ø	kg.x1	vol.x1
130903-000	● nero/black	x1	50	60	200	210	167	36	0,1	mc. 0.0015

**17** b40 base in metallo d.640 con coprisaldatura  
b40 metal base d.640 with cover welding

code	finishing	q.kit	q.pack	a	ø	kg.x1	vol.x1
110210-027	● cromato/chrome	x1	5	60	640	2,85	mc. 0.014

CPG  
plastic cover for swivel frame



➔ for all colour codes, see page 123

# oki

bench



plastic colours

- nero/black
- bianco/white 218
- blu/blue 5002

16 04 08 14

**16** oki-supporto per attacco scocca oki su panca  
smile-bench frame for oki shell

code	finishing	q.kit	q.pack	a	b	kg.x1	vol.x1
110703-053	● nero/black	x1	15	306	209	1.40	mc. 0.004

main component sizes

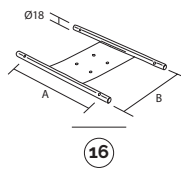

for the components below, see page 121

04 08 14

for all colour codes, see page 123

for the bench components, see page 201

optionals

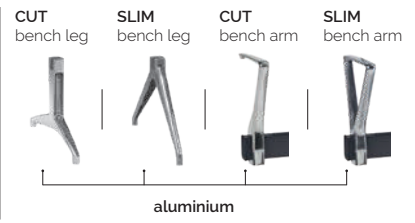
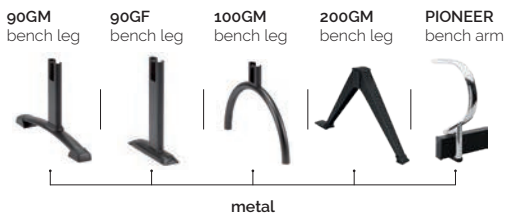
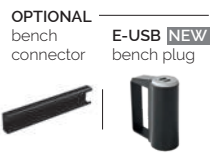

# oki

optional colour codes



## shell colour codes



04 scocca in plastica  
plastic shells

- 133903-050 nero/black
- 133905-050 bianco/white 218
- 133915-050 blu/blue 5002





BEYOND **Solutions**

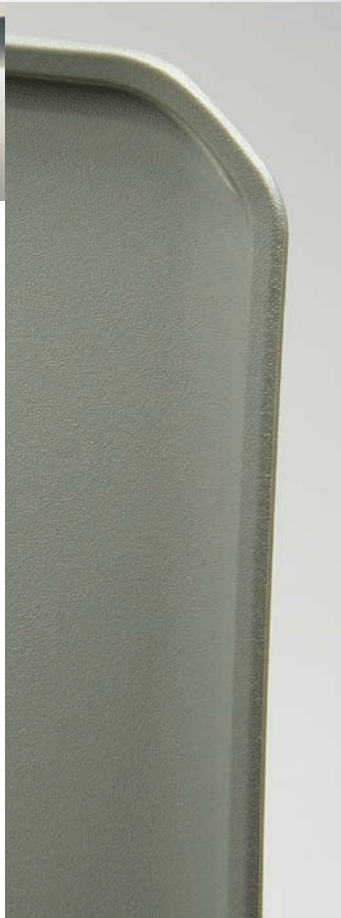



**race**





# race



---

slide  
slide w/armrests  
stool

4 legs  
4 legs w/armrests

swivel

bench

## race showing

---

### features



trolley  
available



Una monoscocca dal **design geometrico e moderno**, disponibile in **8 vivaci colori**; **opzionale il pannellino da tappezzare**.

L'ampia offerta di telai, che vanno dallo sgabello alla panca, disponibili in varie finiture, la rendono capace di adattarsi a ogni contesto, soprattutto **in ambienti Contract e Community** anche grazie alla **pratica impilabilità**.

*A monocoque chair featuring a **geometric and modern design**, available in **8 bright colours**; **optional seat panel can be upholstered**.*

*The wide range of frames, ranging from stool to bench, available in various finishes, mean it can be adapted to any context, especially in **Contract and Community environments**, and its **stackability means it is also highly practical**.*

# race

## slide

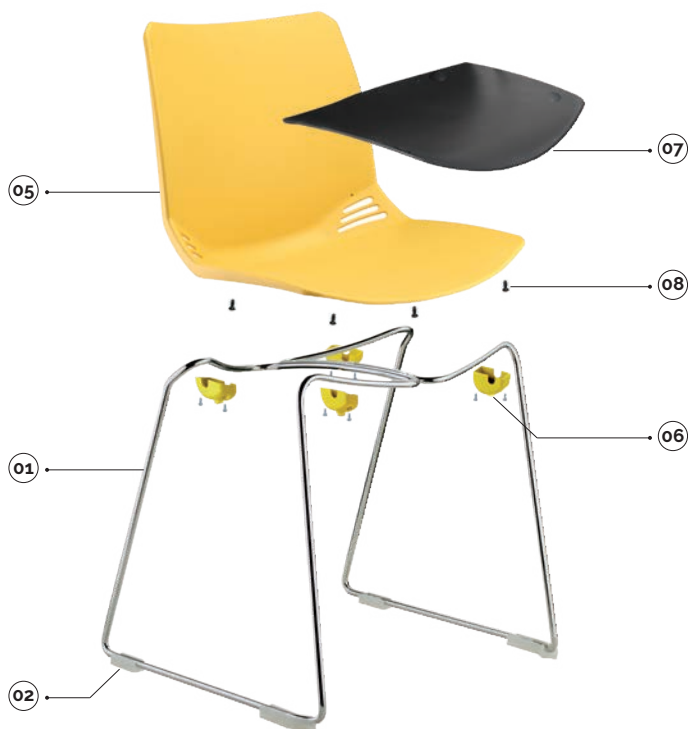

plastic colours

- blu/blue ral5002
- arancio/orange ral2009
- viola/purple 145
- verde/green 736
- avorio/ivory ral1013
- grigio/grey ral7003
- giallo/yellow ral1012
- marrone/brown ral8022

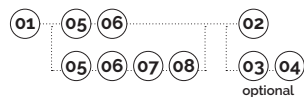

main component sizes

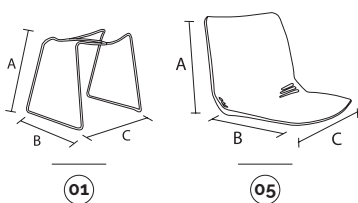

optipnats

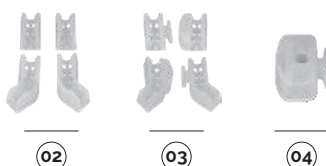

### 01 race-telaio slitta in tondino per scocca senza tappi

race-slide wire frame for shell without caps

code	finishing	q.kit	q.pack	a	b	c	kg.x1	vol.x1
113410-065	● cromato/chrome	x1	100	460	500	470	3,20	mc. 0.026

### 02 btf-kit piedini

btf-kit feet

code	finishing	q.kit	q.pack	kg.x1
134306-001	○ neutro/neutral	x1	100	0,05

### 03 btfa-kit piedini con ganci

btfa-kit feet with hooks

code	finishing	q.kit	q.pack	kg.x1
134306-002	○ neutro/neutral	x1	100	0,06

### 04 pptf-tappo per fissaggio pavimento

pptf-cap for fixing to the floor

code	finishing	q.kit	q.pack	kg.x1
134306-003	○ neutro/neutral	x2	100	0,03

### 05 race-scocca intera modello race

race-plastic shell model race

code	finishing	q.kit	q.pack	a	b	c	kg.x1	vol.x1
133908-012	● giallo/yellow ral1012	x1	10	380	410	450	1,60	mc. 0.02

### 06 race-confezione accessori per scocca race

race-accessory pack for shell race

code	finishing	q.kit	q.pack	kg.x1	vol.x1
137008-006	● giallo/yellow ral1012	x1	10	telaio in tondino/wire frame	0,085 mc. 0.001

### 07 race-pannello sedile da tappezzare

race-back panel for upholstery

code	finishing	q.kit	q.pack	kg.x1	vol.x1
132203-049	● nero/black	x1	20	0,53	mc. 0.003

### 08 confezione viti tbl+ fr. d.5x14 per pannello da tappezzare

screws tbl+ fr.hilo d.5x14 zinc.black (to fix seat panel) package

code	finishing	q.kit	q.pack
117003-071	● nero/black	x4	200

### race-carrello portasedie con accessori verniciato nero

race-trolley for chairs with accessories painted black

code	finishing	q.kit
110803-348	● nero/black	x1



for all colour codes, see page 135



# race

slide w/armrests

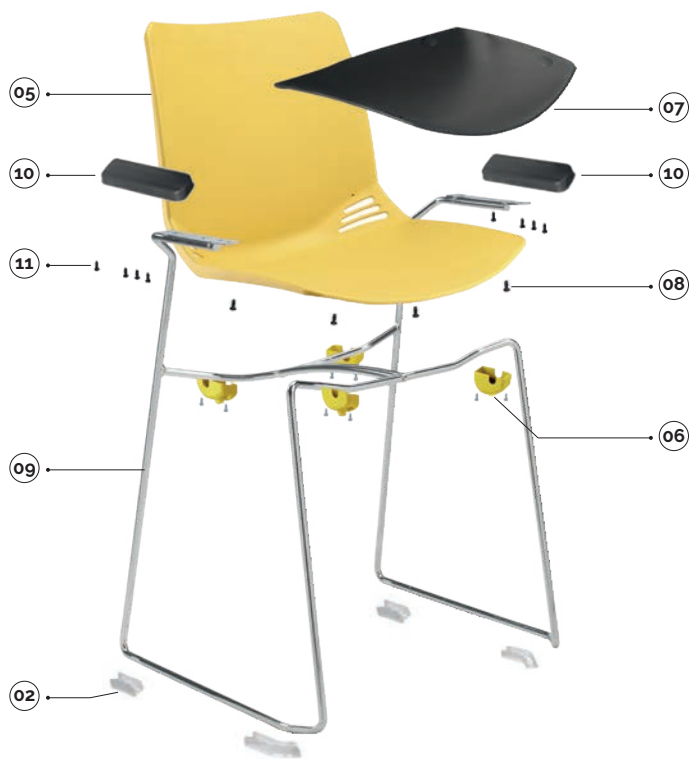

plastic colours

- blu/blue ral5002
- arancio/orange ral2009
- viola/purple 145
- verde/green 736
- avorio/ivory ral1013
- grigio/grey ral7003
- giallo/yellow ral1012
- marrone/brown ral8022

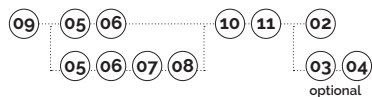

main component sizes

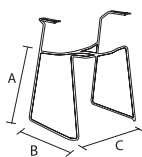

09

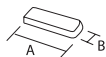

10

**09** race-telaio slitta con braccioli in tondino per scocca senza tappi  
race-slide wire frame with arms for shell without caps

code	finishing	q.kit	q.pack	a	b	c	kg.x1	vol.x1
113410-064	● cromato/chrome	x1	60	460	500	470	4.20	mc. 0.035

**10** race-bracciolo plastica colorato per telaio filo  
race-colored plastic arm for wire frame

code	finishing	q.kit	q.pack	a	b	kg.x1	vol.x1
131703-019	● nero/black	x2	40	175	55	0.10	mc. 0.0004

**11** vite hilo tbl+ fr. d.5x12 zincata nera(per fissare bracciolo tondino)  
screw tbl+fr:hilo d.5x12 zinc.black(to fix wire arms)

code	finishing	q.kit
117803-154	● nero/black	x4

for the components below, see page 128

02 03 04 05 06 07 08



for all colour codes, see page 135



# race

## stool

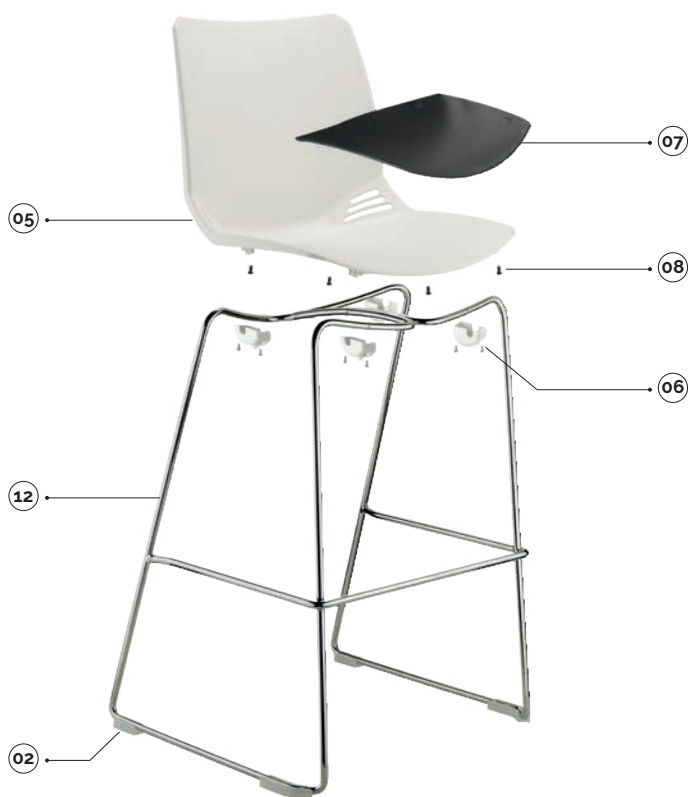

plastic colours

- blu/blue ral5002
- arancio/orange ral2009
- viola/purple 145
- verde/green 736
- avorio/ivory ral1013
- grigio/grey ral7003
- giallo/yellow ral1012
- marrone/brown ral8022

main component sizes

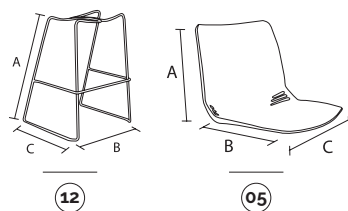

options

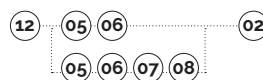

### 12 race-sgabello alto in tondino per scocca senza tappi race-wire high bar stool for shell without caps

code	finishing	q.kit	q.pack	a	b	c	kg.x1	vol.x1
113410-066	● cromato/chrome	x1	50	700	500	550	5,85	mc. 0.08

### 02 btf-kit piedini btf-kit feet

code	finishing	q.kit	q.pack	kg.x1
134306-001	○ neutro/neutral	x1	100	0,05

### 05 race-scocca intera modello race race-plastic shell model race

code	finishing	q.kit	q.pack	a	b	c	kg.x1	vol.x1
133905-012	○ avorio/ivory ral1013	x1	10	380	410	450	1,60	mc. 0.02

### 06 race-confezione accessori per scocca race race-accessory pack for shell race

code	finishing	q.kit	q.pack	kg.x1	vol.x1
137005-006	○ avorio/ivory ral1013	x1	10	telaio in tondino/wire frame	0,085 mc. 0.001

### 07 race-pannello sedile da tappezzare race-back panel for upholstery

code	finishing	q.kit	q.pack	kg.x1	vol.x1
132203-049	● nero/black	x1	20	0,53	mc. 0.003

### 08 confezione viti tbl+ fr. d.5x14 per pannello da tappezzare screws tbl+ fr.hilo d.5x14 zinc.black (to fix seat panel) package

code	finishing	q.kit	q.pack
117003-071	● nero/black	x4	200



for all colour codes, see page 135

# race

4-legs



plastic colours

- blu/blue ral5002
- arancio/orange ral2009
- viola/purple 145
- verde/green 736
- avorio/ivory ral1013
- grigio/grey ral7003
- giallo/yellow ral1012
- marrone/brown ral8022

main component sizes

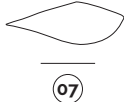
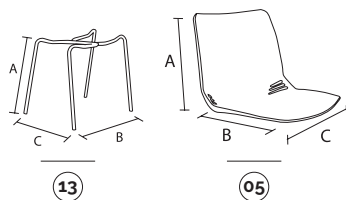

optional

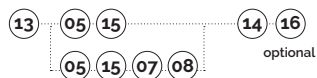
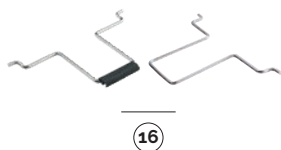

## 13 race-telaio 4 gambe in tubo d.18 senza tappi race-4 legs frame d.18 without caps

code	finishing	q.kit	q.pack	a	b	c	kg.x1	vol.x1
112703-015	● nero/black	x1	150	460	500	470	1.85	mc. 0.014
112707-015	● marrone/brown ral8022	x1	150	460	500	470	1.85	mc. 0.014
112704-015	● grigio/gray ral7003	x1	150	460	500	470	1.85	mc. 0.014
112705-015	○ avorio/ivory ral1013	x1	150	460	500	470	1.85	mc. 0.014
112710-015	● cromato/chrome	x1	150	460	500	470	1.85	mc. 0.014

## 14 confezione puntali tondi d.18 neri black inner round caps d.18 package

code	finishing	q.kit	q.pack
137003-072	● nero/black	x4	200
134205-181	○ bianco/white	x4	

## 05 race-scocca intera modello race race-plastic shell model race

code	finishing	q.kit	q.pack	a	b	c	kg.x1	vol.x1
133916-012	● verde/green 736	x1	10	380	410	450	1.60	mc. 0.02

## 15 race-confezione accessori per scocca race race-accessory pack for shell race

code	finishing	q.kit	q.pack	kg.x1	vol.x1
137016-005	● verde/green 736	x1	10	telaio tubo/tube frame	0,085 mc. 0.001

## 07 race-pannello sedile da tappezzare race-back panel for upholstery

code	finishing	q.kit	q.pack	kg.x1	vol.x1
132203-049	● nero/black	x1	20	0,53	mc. 0.003

## 08 confezione viti tbl+ fr. d.5x14 per pannello da tappezzare screws tbl+ fr.hilo d.5x14 zinc.black (to fix seat panel) package

code	finishing	q.kit	q.pack
117003-071	● nero/black	x4	200

## 16 race-coppia agganci laterale in tondino + plastica race-pair side wire hooks + plastic

code	finishing	q.kit	q.pack	kg.x1	vol.x1
113410-004	● cromato/chrome	x1	50	0,15	mc. 0.0004



for all colour codes, see page 135

# race

4-legs w/armrests



plastic colours

- blu/blue ral5002
- arancio/orange ral2009
- viola/purple 145
- verde/green 736
- avorio/ivory ral1013
- grigio/grey ral7003
- giallo/yellow ral1012
- marrone/brown ral8022



main component sizes

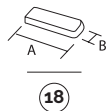
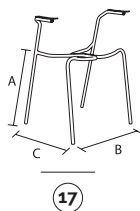

**17** race-telaio 4 gambe in tubo d.18 con braccioli senza tappi  
race-4 legs frame d.18 with arms without caps

code	finishing	q.kit	q.pack	a	b	c	kg.x1	vol.x1
112703-016	● nero/black	x1	60	460	500	470	3.40	mc. 0.035
112707-016	● marrone/brown ral8022	x1	60	460	500	470	3.40	mc. 0.035
112704-016	● grigio/gray ral7003	x1	60	460	500	470	3.40	mc. 0.035
112705-016	○ avorio/ivory ral1013	x1	60	460	500	470	3.40	mc. 0.035
112710-016	● cromato/chrome	x1	60	460	500	470	3.40	mc. 0.035

**18** race-bracciolo plastica colorato per telaio 4 gambe  
race-colored plastic arm for 4 legs frame

code	finishing	q.kit	q.pack	a	b	kg.x1	vol.x1
131703-017	● nero/black	x2	40	175	55	0.10	mc. 0.0004

**19** vite hilo tbl+ fr. d.5x14 zincata nera (per fissare bracciolo in tubo)  
screw tbl+fr:hilo d.5x14 zinc.black (to fix tube arms)

code	finishing	q.kit
117803-156	● nero/black	x4

for the components below, see page 131



for all colour codes, see page 135



race-carrello portasedie con accessori verniciato nero  
race-trolley for chairs with accessories painted black

code	finishing	q.kit
110803-348	● nero/black	x1



# race

## swivel



plastic colours

- blu/blue ral5002
- arancio/orange ral2009
- viola/purple 145
- verde/green 736
- avorio/ivory ral1013
- grigio/grey ral7003
- giallo/yellow ral1012
- marrone/brown ral8022

main component sizes

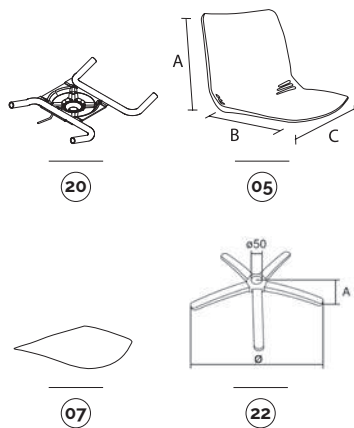

optionals

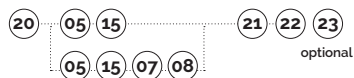
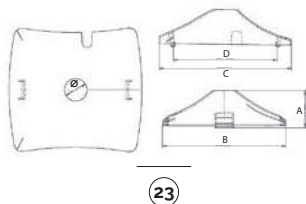

### 20 race-supperto girevole a gas per scocca race

race-swivel frame for race shell

code	finishing	q.kit	q.pack	kg.x1	vol.x1
110903-070	● nero/black	x1	8	1.40	mc. 0.005
110904-070	● grigio/grey ral7003	x1	8	1.40	mc. 0.005

### 21 confezione tappi copritesta d.18 neri

black cover head caps d.18 package

code	finishing	q.kit	q.pack
137003-070	● nero/black	x4	200

### 05 race-scocca intera modello race

race-plastic shell model race

code	finishing	q.kit	q.pack	a	b	c	kg.x1	vol.x1
133905-012	○ avorio/ivory ral1013	x1	10	380	410	450	1.60	mc. 0.02

### 15 race-confezione accessori per scocca race

race-accessory pack for shell race

code	finishing	q.kit	q.pack	kg.x1	vol.x1
137005-005	○ avorio/ivory ral1013	x1	10	telaio tubo/tube frame	0,085 mc. 0.001

### 07 race-pannello sedile da tappezzare

race-back panel for upholstery

code	finishing	q.kit	q.pack	kg.x1	vol.x1
132203-049	● nero/black	x1	20	0.53	mc. 0.003

### 08 confezione viti tbl+ fr. d.5x14 per pannello da tappezzare

screws tbl+ fr.hilo d.5x14 zinc.black (to fix seat panel) package

code	finishing	q.kit	q.pack
117003-071	● nero/black	x4	200

### 22 b40 base in metallo d.640 con coprisaldatura

b40 metal base d.640 with cover welding

code	finishing	q.kit	q.pack	a	ø	kg.x1	vol.x1
110210-027	● cromato/chrome	x1	5	60	640	2.85	mc. 0.014

### 23 cpg-copertina in plastica per telaio girevole

cpg-plastic cover for swivel frame

code	finishing	q.kit	q.pack	a	b	c	d	ø	kg.x1	vol.x1
130903-000	● nero/black	x1	50	60	200	210	167	36	0.1	mc. 0.0015

CPG  
plastic cover for swivel frame



for all colour codes, see page 135

# race

## bench



plastic colours

- blu/blue ral5002
- arancio/orange ral2009
- viola/purple 145
- verde/green 736
- avorio/ivory ral1013
- grigio/grey ral7003
- giallo/yellow ral1012
- marrone/brown ral8022

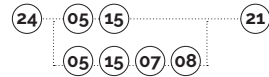

main component sizes

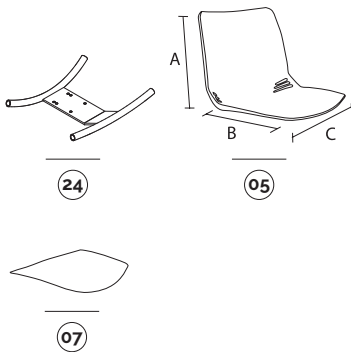

### 24 race-supporto per attacco scocca race su panca race-bench frame for race shell

code	finishing	q.kit	q.pack	kg.x1	vol.x1
110703-210	● nero/black	x1	15	1,30	mc. 0.004

### 21 confezione tappi copritesta d.18 neri black cover head caps d.18 package

code	finishing	q.kit	q.pack
137003-070	● nero/black	x4	200

### 05 race-scocca intera modello race race-plastic shell model race

code	finishing	q.kit	q.pack	a	b	c	kg.x1	vol.x1
133905-012	○ avorio/ivory ral1013	x1	10	380	410	450	1,60	mc. 0.02

### 15 race-confezione accessori per scocca race race-accessory pack for shell race

code	finishing	q.kit	q.pack	kg.x1	vol.x1
137005-005	○ avorio/ivory ral1013	x1	10	telaio tubo/tube frame	0,085 mc. 0.001

### 07 race-pannello sedile da tappezzare race-back panel for upholstery

code	finishing	q.kit	q.pack	kg.x1	vol.x1
132203-049	● nero/black	x1	20	0,53	mc. 0.003

### 08 confezione viti tbl+ fr. d.5x14 per pannello da tappezzare screws tbl+ fr.hilo d.5x14 zinc.black (to fix seat panel) package

code	finishing	q.kit	q.pack
117003-071	● nero/black	x4	200

for the bench components, see page 201



for all colour codes, see page 135

optionals

OPTIONAL  
bench  
connector



E-USB **NEW**  
bench plug



JIM **NEW**  
bench leg



APOLL  
bench arm



plastic

90GM  
bench leg



90GF  
bench leg



100GM  
bench leg



200GM  
bench leg



PIONEER  
bench arm



metal

CUT  
bench leg



SLIM  
bench leg



CUT  
bench arm



SLIM  
bench arm



aluminium

# race

## optional colour codes

### shell colour codes



05 scocche in plastica  
plastic shells

- 133915-012 blu/blue ral5002
- 133907-012 arancio/orange ral2009
- 133914-012 viola/purple 145
- 133916-012 verde/green 736
- 133905-012 avorio/ivory ral1013
- 133904-012 grigio/grey ral7003
- 133908-012 giallo/yellow ral1012
- 133907-013 marrone/brown ral8022



### accessory colour codes



06 accessori in plastica per telaio in tondino  
plastic accessories for wire frame

- 137015-006 blu/blue ral5002
- 137007-007 arancio/orange ral2009
- 137014-006 viola/purple 145
- 137016-006 verde/green 736
- 137005-006 avorio/ivory ral1013
- 137004-006 grigio/grey ral7003
- 137008-006 giallo/yellow ral1012
- 137007-008 marrone/brown ral8022



15 accessori in plastica per telaio in tubo  
plastic accessories for tube frame

- 137015-005 blu/blue ral5002
- 137007-005 arancio/orange ral2009
- 137014-005 viola/purple 145
- 137016-005 verde/green 736
- 137005-005 avorio/ivory ral1013
- 137004-005 grigio/grey ral7003
- 137008-005 giallo/yellow ral1012
- 137007-006 marrone/brown ral8022

### armrest colour codes



10 braccioli in plastica per telaio a filo  
plastic armrests for wire frame

- 131704-019 grigio/grey ral7003
- 131703-019 nero/black
- 131705-0179 avorio/ivory ral1013



18 braccioli in plastica per telaio 4 gambe  
plastic armrests for 4-legs frame

- 131704-017 grigio/grey ral7003
- 131703-017 nero/black
- 131705-017 avorio/ivory ral1013





BEYOND **Logistic**

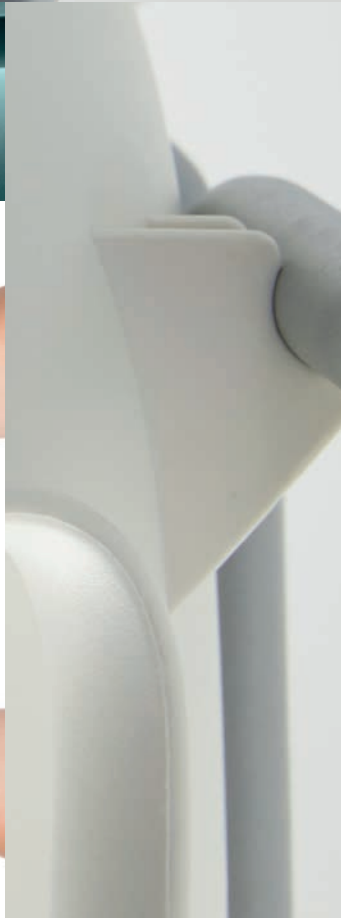



**smile**

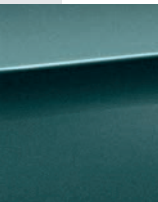

# smile



---

slide  
stool

4 legs

swivel

bench

## smile showing

---



Una **monoscocca in plastica ampia, confortevole e avvolgente**, caratterizzata da un **design distintivo e solido**, grazie anche alla gamma di colori vivaci in cui viene proposta.

L'ampia scelta di telai, che vanno dallo sgabello alla panca, disponibili in varie finiture, le permettono di adattarsi a ogni tipo di ambiente, **dall'Home all'Office**. Grazie all'impilabilità e alla facilità di pulizia, **Smile** si adatta bene anche **all'ambiente Community**.

*A **monocoque plastic chair with an ample, comfortable and enveloping seat**, characterized by a **distinctive and solid design**, thanks also to the range of bright colour options on offer.*

*The wide selection of frames ranges from stool to bench versions, and are available in various finishes, thus enabling it to be adapted to any type of environment, **from Home to Office**. Thanks to its stackability and ease of cleaning, **Smile** also adapts well to **Community environments**.*



# smile

slide

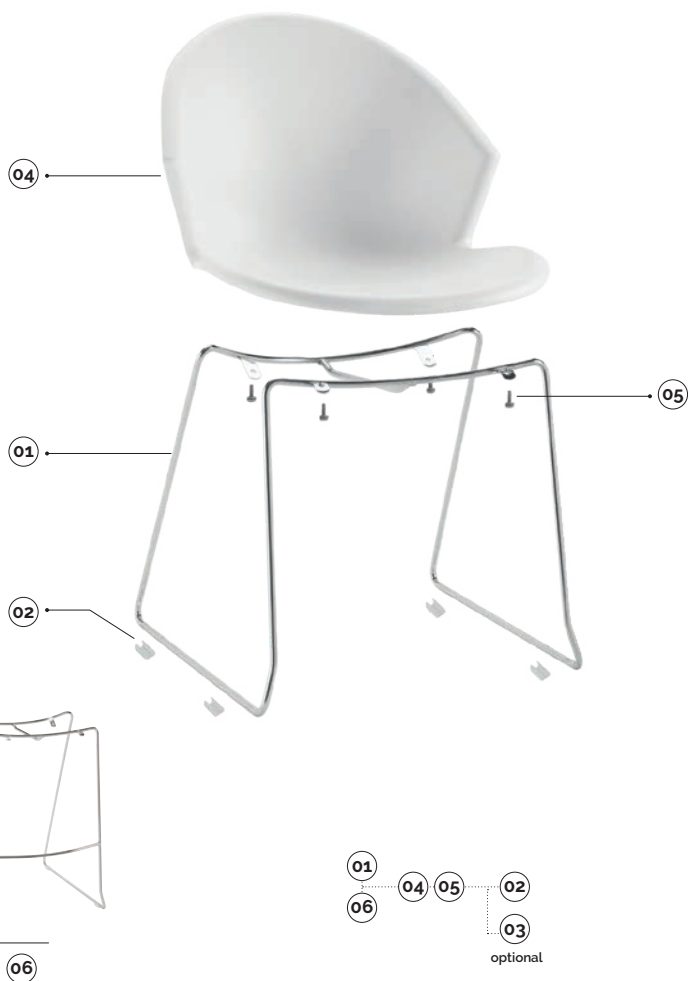

plastic colours

- nero/black
- bianco/white 218
- blu/blue 5002

main component sizes

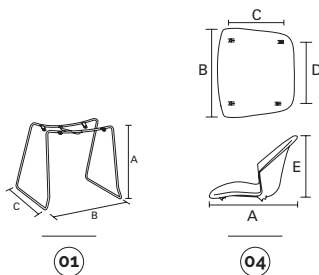

optional

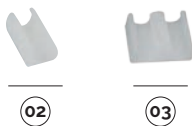

**01** smile-sgabello in tondino cromato per scocca senza tappi  
smile-chrome wired frame stool for shell without caps

code	finishing	q.kit	q.pack	a	b	c	kg.x1	vol.x1
113410-018	● cromato/chrome	x1	100	450	500	500	3,20	mc. 0.04

**02** confezione di basi a pinza antirotazione per tondino colore neutro  
neutral clips base for wire d.11 package

code	finishing	q.kit	q.pack
137006-070	○ neutro/neutral	x4	200

**03** base piana a pinza doppia in pe per tondo per unione sedie  
double flat clip base for tube

code	finishing	q.kit
134006-021	○ neutro/neutral	x4

**04** smile-scocca intera modello smile  
smile-shell model smile

code	finishing		q.kit	q.pack	a	b	c	d	e	kg.x1	vol.x1
133905-053	○ bianco/white	218	x1	10	540	510	235	277	395	1,50	mc. 0.015

**05** vite autoflettante 5,5x19 testa cilindrica a croce zincata (vite fissaggio scocca)  
auto-thread screw 5,5x19 cylindrical head cross zinc (screw for shell fixing)

code	finishing	q.kit
117811-180	● zincata/zinc	x4

**06** smile-sgabello alto in tondino cromato per scocca senza tappi  
smile-chrome wired frame tall stool for shell without caps

code	finishing	q.kit	q.pack	a	b	c	kg.x1	vol.x1
113410-019	● cromato/chrome	x1	50	700	500	560	5,00	mc. 0.08



for all colour codes, see page 143

# smile

4-legs



plastic colours

- nero/black
- bianco/white 218
- blu/blue 5002

07 04 09 08

main component sizes

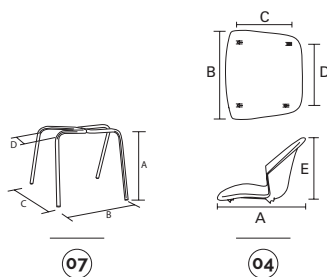

**07** smile-sgabello 4 gambe in tubo d.20 senza tappi  
smile-4 legs stool d.20 without caps

code	finishing	q.kit	q.pack	a	b	c	d	kg.x1	vol.x1
112703-030	● nero/black	x1	150	430	440	540	260	1,92	mc. 0,02
112704-030	● grigio/grey	x1	150	430	440	540	260	1,92	mc. 0,02
112710-030	● cromato/chrome	x1	150	430	440	540	260	1,92	mc. 0,02

**08** tappi-puntale alettato d.20 nero  
inner caps-black round insert cap d.20

code	finishing	q.kit
134203-200	● nero/black	x4

**04** smile-scocca intera modello smile  
smile-shell model smile

code	finishing	q.kit	q.pack	a	b	c	d	e	kg.x1	vol.x1
133905-053	○ bianco/white 218	x1	10	540	510	235	277	395	1,50	mc. 0,015

**09** confezione viti hilo d.5x35 testa svasata a croce zincate (vite fissaggio scocca)  
screws auto-thread 5x35 flared cross head zinc for shell fixing package

code	finishing	q.kit	q.pack
117011-070	○ zincata/zinc	x4	200



for all colour codes, see page 143

# smile

swivel



plastic colours

- nero/black
- bianco/white 218
- blu/blue 5002

10 04 09 11 12  
optional

main component sizes

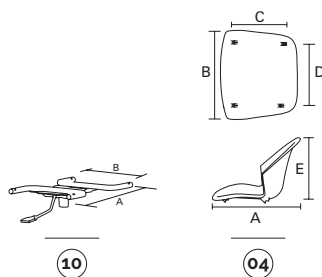

optipnals

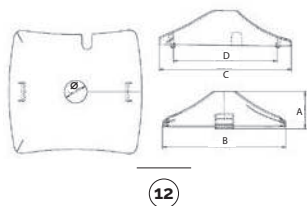

## 10 smile-supporto girevole a gas per scocca smile smile-gas lift swivel metal frame for smile shell

code	finishing	q.kit	q.pack	a	b	kg.x1	vol.x1
110903-030	● nero/black	x1	10	277	235	1,40	mc. 0,004
110904-008	● grigio/grey	x1	10	277	235	1,40	mc. 0,004

## 11 tappi-tappo copritesta alettato d.20 nero caps-cover head d.20 black

code	finishing	q.kit
134103-200	● nero/black	x4

## 04 smile-scocca intera modello smile smile-shell model smile

code	finishing	q.kit	q.pack	a	b	c	d	e	kg.x1	vol.x1
133915-053	● blu/blue 5002	x1	10	540	510	235	277	395	1,50	mc. 0,015

## 09 confezione viti hilo 5x35 testa svasata a croce zincate (vite per fissaggio scocca) screws auto-thread 5x35 flared cross head zinc (screw for shell fixing) package

code	finishing	q.kit	q.pack
117011-070	● zincata/zinc	x4	200

## 12 cpg-copertina in plastica per telaio girevole cpg-plastic cover for swivel frame

code	finishing	q.kit	q.pack	a	b	c	d	ø	kg.x1	vol.x1
130903-000	● nero/black	x1	50	60	200	210	167	36	0,1	mc. 0,0015

CPG  
plastic cover for swivel frame



for all colour codes, see page 143

# smile

bench



plastic colours

- nero/black
- bianco/white 218
- blu/blue 5002

13 04 09 11

**13** smile-supporto per attacco scocca smile su panca  
smile-bench frame for oki shell

code	finishing	q.kit	q.pack	a	b	kg.x1	vol.x1
110703-087	● nero/black	x1	10	277	235	1.40	mc. 0.004

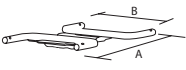

13

for the components below, see page 142



for all colour codes, see below

04 09 11

main component sizes

for the bench components, see page 201

optionals

OPTIONAL  
bench  
connector

E-USB **NEW**  
bench plug



JIM **NEW**  
bench leg

APOLL  
bench arm



plastic

90GM  
bench leg

90GF  
bench leg

100GM  
bench leg

200GM  
bench leg

PIONEER  
bench arm



metal

CUT  
bench leg

SLIM  
bench leg

CUT  
bench arm

SLIM  
bench arm



aluminium

## smile

optional colour codes



### shell colour codes

**04** scocche in plastica  
plastic shells

- 133903-053 nero/black
- 133905-053 bianco/white 218
- 133915-053 blu/blue 5002







**perù**

---

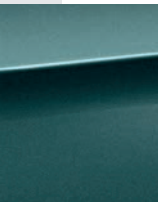

# perù



---

4 legs

swivel

bench



perù showing



tools



brochure



Una sedia dal **design minimal**, ma **molto robusta**, con la scocca disponibile in tre colori neutri.

Particolarmente leggera e facile da movimentare, grazie a una pratica maniglia posta sulla parte posteriore.

È inoltre **impilabile** e facile da pulire, con il piccolo foro sulla seduta; si adatta a **ogni ambiente**.

*A chair with a **minimal but very robust design**, with seat shell available in three neutral colours.*

*Particularly lightweight and easy to handle, thanks to a practical handle located on the back.*

*It is also **stackable** and easy to clean, featuring a small hole on the seat; adapts to **any environment**.*

# perù

## 4-legs



plastic colours

- nero/black
- bianco/white 218
- grigio/grey ral7004

01 02 03 04 05

main component sizes

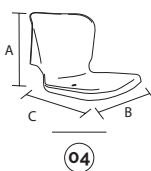
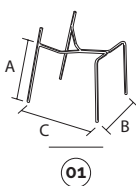

### 01 perù-telaio 4 gambe senza tappi perù-4 legs frames without caps

code	finishing	q.kit	q.pack	a	b	c	kg.x1	vol.x1
110103-185	● nero/black	x1	80	480	440	610	2.0	mc. 0,017
110104-185	● grigio/grey ig2621	x1	80	480	440	610	2.0	mc. 0,017

### 02 tizo-puntale tondo d.20 nero tizo-inner black cap d.20

code	finishing	q.kit
134203-200	● nero/black	x2

### 03 confezione puntali tondi d.18 neri black inner round caps d.18 package

code	finishing	q.kit	q.pack
137003-072	● nero/black	x2	200

### 04 perù-scocca intera modello perù perù-plastic shell model perù

code	finishing	q.kit	q.pack	a	b	c	kg.x1	vol.x1
133903-055	● nero/black	x1	100	395	440	560	1.63	mc. 0,02

### 05 vite autoforante tc+ c/flangia 4,2x13 zincata self-drilling screw tc+ with flange 4,2x13 zinc

code	finishing	q.kit
117811-129	○ zincata/zinc	x4



for all colour codes, see page 151

# perù

## swivel



plastic colours

- nero/black
- bianco/white 218
- grigio/grey rat7004

main component sizes

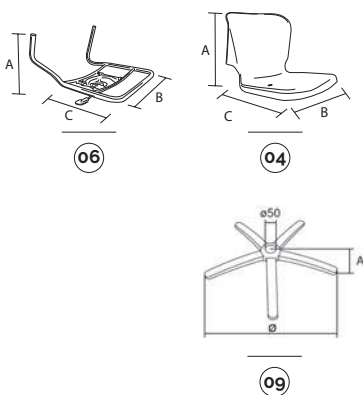

optional

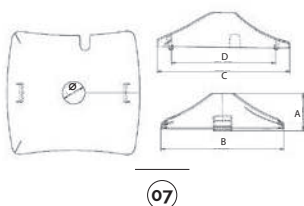

### 06 perù-supporto girevole a gas con accessori per scocca perù perù-swivel frame with accessory for perù shell

code	finishing	q.kit	q.pack	a	b	c	kg.x1	vol.x1
110903-073	● nero/black	x1	100	430	365	280	2,70	mc. 0.01
110904-073	● grigio/grey ig2621	x1	100	430	365	280	2,70	mc. 0.01

### 04 perù-scocca intera modello perù perù-plastic shell model perù

code	finishing	q.kit	q.pack	a	b	c	kg.x1	vol.x1
133903-055	● nero/black	x1	100	395	440	560	1,63	mc. 0.02

### 05 vite autoforante tc+ c/flangia 4,2x13 zincata self-drilling screw tc+ with flange 4,2x13 zinc

code	finishing	q.kit
117811-129	○ zincata/zinc	x4

### 07 cpg-copertina in plastica per telaio girevole cpg-plastic cover for swivel frame

code	finishing	q.kit	q.pack	a	b	c	d	e	kg.x1	vol.x1
130903-000	● nero/black	x1	50	60	200	210	167	36	0.1	mc. 0.0015

### 09 b40 base in metallo d.640 con coprisaldatura b40 metal base d.640 with cover welding

code	finishing	q.kit	q.pack	a	ø	kg.x1	vol.x1
110210-027	● cromato/chrome	x1	5	60	640	2,85	mc. 0.014

CPG  
plastic cover for swivel frame



for all colour codes, see page 151

# perù

## bench



plastic colours

- nero/black
- bianco/white 218
- grigio/grey ral7004

08 04 05

main component sizes

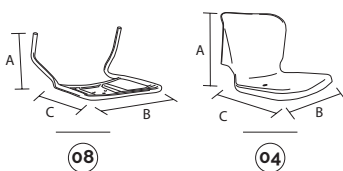

08 perù-supporto per attacco scocca perù su panca  
perù-bench frame for perù shell

code	finishing	q.kit	q.pack	a	b	c	kg.x1	vol.x1
110703-114	● nero/black	x1	100	430	365	230	2,65	mc. 0,01

04 perù-scocca intera modello perù  
perù-plastic shell model perù

code	finishing	q.kit	q.pack	a	b	c	kg.x1	vol.x1
133903-055	● nero/black	x1	100	395	440	560	1,63	mc. 0,02

05 vite autoforante tc+ c/ flangia 4,2x13 zincata  
self-drilling screw tc+ with flange 4,2x13 zinc

code	finishing	q.kit
117811-129	○ zincata/zinc	x4



for all colour codes, see page 151

for the bench components, see page 201

optionals

OPTIONAL  
bench  
connector



E-USB NEW  
bench plug



JIM NEW  
bench leg



APOLL  
bench arm



plastic

90GM  
bench leg



90GF  
bench leg



100GM  
bench leg



200GM  
bench leg



PIONEER  
bench arm



metal

CUT  
bench leg



SLIM  
bench leg



CUT  
bench arm



SLIM  
bench arm



aluminium

# perù

optional colour codes



## shell colour codes



04 scocca in plastica  
plastic shells

- 133903-055 nero/black
- 133904-055 bianco/white 218
- 133905-055 grigio/grey ral7004



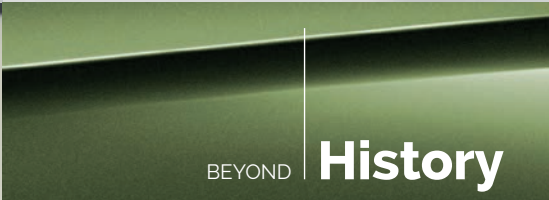



**eden**





# eden



---

4 legs  
stool

## eden showing

---



Grazie al **design semplice ed essenziale** può adattarsi a contesti molto diversi tra loro: **dall' Educational all'ambiente Home.**

Sia il sedile sia lo schienale sono disponibili in diverse colorazioni.

**Eden è impilabile** e disponibile anche nella **versione sgabello.**

*With its **simple and essential design**, Eden can be adapted to a broad range of settings, **from Educational to Home environments.***

*Both the seat and backrest are available in a range of different colours.*

***Eden is stackable** and also available in a **stool version.***

# eden

4-legs

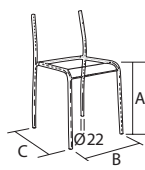
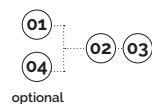

01

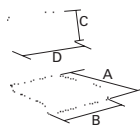

03

**01** eden-telaio fisso senza tappi  
eden-fixed frame without caps

code	finishing	q.kit	q.pack	a	b	c	kg.x1	vol.x1
111903-030	● nero/black	x1	100	470	420	460	3,00	mc. 0.03
111904-020	● grigio/grey	x1	100	470	420	460	3,00	mc. 0.03
111910-030	● cromato/chrome	x1	100	470	420	460	3,00	mc. 0.03

**02** confezione puntali tondi d.22 neri  
black inner round flat caps d.22 package

code	finishing	q.kit	q.pack
137003-073	● nero/black	x4	200

**03** eden-sedile e schienale in plastica  
eden-plastic seat and back

code	finishing	q.kit	q.pack	a	b	c	d	kg.x1	vol.x1
134003-100	● nero/black	x1	20	400	390	180	400	1,50	mc. 0.013
134015-020	● blu/blue	x1	20	400	390	180	400	1,50	mc. 0.013
134005-020	○ avorio/ivory	x1	20	400	390	180	400	1,50	mc. 0.013

# eden

4-legs/frame option

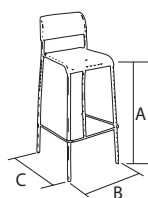

04

main component sizes

**04 eden-sgabello alto fisso senza tappi**  
eden-fixed stool without caps

code	finishing	q.kit	q.pack	a	b	c	kg.x1	vol.x1
111903-032	● nero/black	x1	50	720	420	460	4.10	mc. 0.09
111904-022	● grigio/grey	x1	50	720	420	460	4.10	mc. 0.09
111910-029	● cromato/chrome	x1	50	720	420	460	4.10	mc. 0.09

**02 confezione puntali tondi d.22 neri**  
black inner round flat caps d.22 package

code	finishing	q.kit	q.pack
137003-073	● nero/black	x4	200



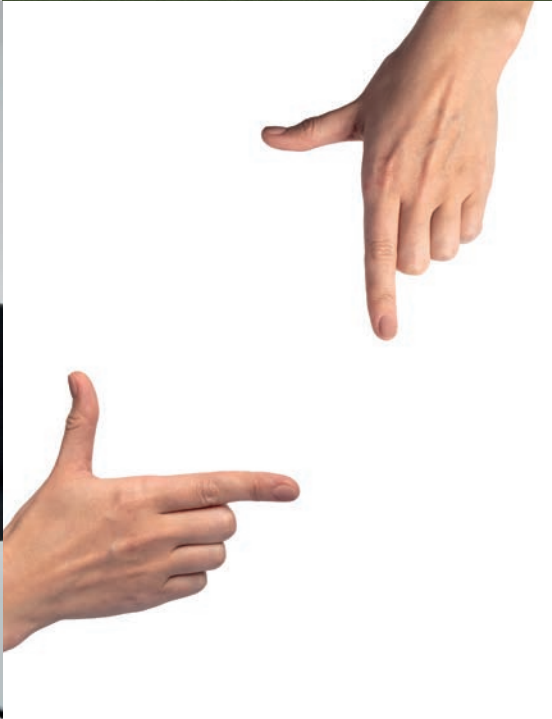
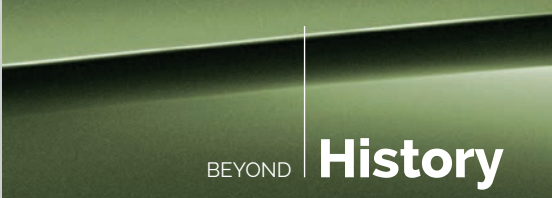



**paco**



# paco



---

4 legs



## paco showing

---



Uno **sgabello dallo stile classico**, dotato di una comoda seduta in monoscocca di plastica, disponibile in tre diverse colorazioni, e di una struttura sagomata in acciaio, cromata o grigia.

**Paco** è pratico e versatile, pensato per gli **ambienti Contract**.

*A classically-styled stool, featuring a comfortable monocoque plastic seat.*

*Available in three different colours, it features a contoured frame in steel, chrome or grey.*

**Paco** is practical and versatile, designed for **Contract environments**.

# paco

4-legs



plastic colours

- antracite/grey ppl17
- beige/beige ppl09
- blu/blue ppl14

main component sizes

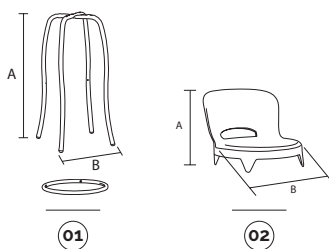

01 02

**01** paco-telaio smontato per sgabello alto con accessori per il montaggio  
paco-frame not assembled for high stool with accessories for assemblage

code	finishing	q.kit	q.pack	a	b	kg.x1	vol.x1
110604-090	● grigio/grey	x1	6	800	370	3,45	mc. 0,02
110610-080	● cromato/chrome	x1	6	800	370	3,45	mc. 0,02

**02** paco-scocca intera in plastica  
paco-plastic shell

code	finishing	q.kit	q.pack	a	b	kg.x1	vol.x1
133904-025	● antracite/grey ppl17	x1	12	230	380	1,38	mc. 0,02
133905-040	● beige/beige ppl09	x1	12	230	380	1,38	mc. 0,02
133915-040	● blu/blue ppl14	x1	12	230	380	1,38	mc. 0,02

lo sgabello standard comprende la confezione accessori per il montaggio  
the kit of accessories for the assemblage is included with the stool







BEYOND **Logistic**

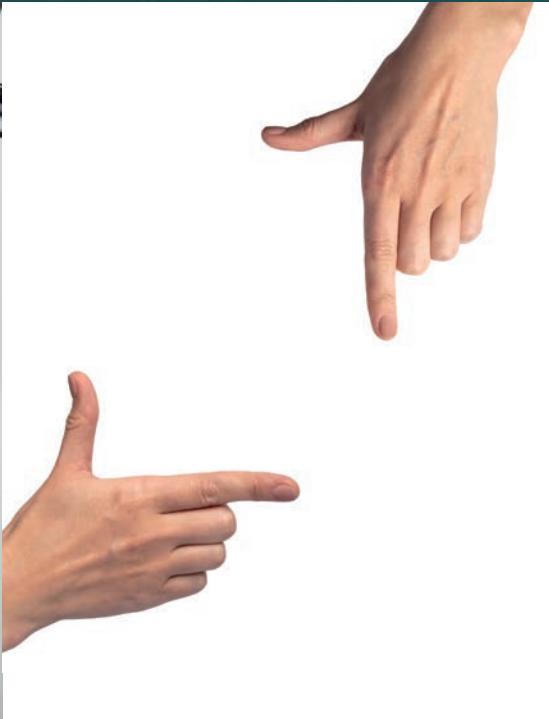



q9



# q9



---

slide

4 legs

bench

slide w/armrests

q9 showing

---



Un **concetto innovativo di monoscocca**, dal disegno distintivo e dalle dimensioni generose.

Nata per arredare **con importanza** e grande carattere sia il **front office** sia le **meeting room**.

Disponibile sia con pannelli da tappezzare sia con cornice per schienale in rete, risulta perfetta in tutte le situazioni.

*An **innovative monocoque concept**, with an eye-catching design and generous dimensions.*

*Designed to furnish both **front office** and **meeting rooms** and **confer importance** and great character.*

*Available both with panels to be upholstered and with optional frame for a mesh backrest, making it perfect in all settings.*



# q9

## slide

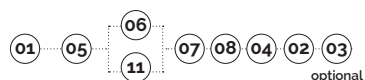

main component sizes

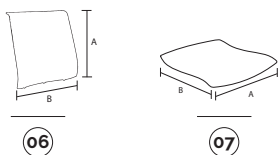
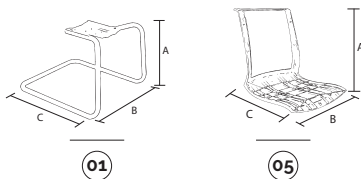

optional

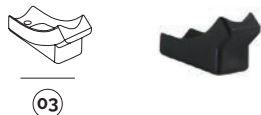

### 01 q9-base a slitta in tubo d.25 tappi esclusi

q9-slide frame pipe d.25 without caps

code	finishing	q.kit	q.pack	a	b	c	kg.x1	vol.x1
110503-131	● nero/black	x1	64	400	560	550	4.10	mc. 0.032
110504-131	● grigio/grey	x1	64	400	560	550	4.10	mc. 0.032
110510-111	● cromato/chrome	x1	64	400	560	550	4.10	mc. 0.032

### 02 pinza due pioli in polietilene nera

pliers two pin black

code	finishing	q.kit
134003-003	● nero/black	x6

### 03 piedino antiribaltamento in plastica nera

plastic black feet anti-upsetting

code	finishing	q.kit	q.pack	kg.x1	vol.x1
134303-006	● nero/black	x2	100	0.025	mc. 0.0001

### 04 tappo copritesta d.25

cover head cap d.25

code	finishing	q.kit
134110-250	● cromato/chrome	x2
134103-250	● nero/black	x2

### 05 q9-monoscocca in plastica+confezione

q9-plastic shell + packaging

code	finishing	q.kit	q.pack	a	b	c	kg.x1	vol.x1
133903-007	● nero/black	x1	5	550	480	480	3.20	mc. 0.021
133905-007	○ bianco/white	x1	5	550	480	480	3.20	mc. 0.021

### 06 q9-pannello schienale in plastica da tappezzare

q9-frame back in plastic for upholstery

code	finishing	q.kit	q.pack	a	b	kg.x1	vol.x1
132103-061	● nero/black	x1	10	460	460	1.30	mc. 0.01
132105-012	○ bianco/white	x1	10	460	460	1.30	mc. 0.01

### 07 q9-pannello sedile in plastica da tappezzare

q9-frame seat in plastic for upholstery

code	finishing	q.kit	q.pack	a	b	kg.x1	vol.x1
132203-040	● nero/black	x1	10	480	480	0.80	mc. 0.009

### 08 vite testa cilindrica a croce m6x16 zincata (per fissare scocca)

screw cylindrical cross head m6x16 zinc (for fix shell)

code	finishing	q.kit
117711-191	○ zincata/zinc	x4

# q9

slide w/armrests



main component sizes

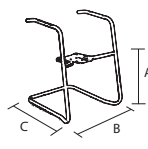

09



11

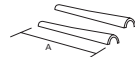

12



03



optional

**09** q9-base a slitta con braccioli in tubo d.25 tappi esclusi  
q9-slide frame pipe d.25 with arms without caps

code	finishing	q.kit	q.pack	a	b	c	kg.x1	vol.x1
110503-095	● nero/black	x1	36	400	560	550	5,60	mc. 0.045
110504-132	● grigio/grey	x1	36	400	560	550	5,60	mc. 0.045
110510-132	● cromato/chrome	x1	36	400	560	550	5,60	mc. 0.045

**10** tappo copritesta cromato d.25  
cover head cap d.25 chrome

code	finishing	q.kit
134110-250	● cromato/chrome	x2

**11** q9-cornice schienale in plastica per rete  
q9-plastic back frame for mesh

code	finishing	q.kit	q.pack	a	b	kg.x1	vol.x1
132103-060	● nero/black	x1	20	460	460	0,52	mc. 0.007
132105-011	○ bianco/white	x1	20	460	460	0,52	mc. 0.007

**12** q9-bracciolo destro e sinistro plastica conico  
q9-black plastic conic arm

code	finishing	q.kit	q.pack	a	kg.x1	vol.x1
131703-041	● nero/black	x2	200	205	0,04	mc. 0.0002

**13** confezioni viti trucciolari tsp+ d.4x25 zincate (per fissare braccioli)  
shaving screws tsp+ d.4x25 zinc package

code	finishing	q.kit	q.pack
117011-072	○ zincata/zinc	x4	200

for the components below, see page 168

02 03 04 05 07 08

# q9

4-legs

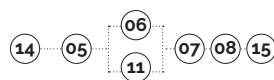

main component sizes

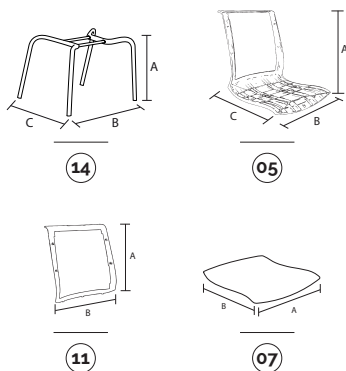

## 14 q9-telaio 4 gambe in tubo d.25 q9-pipe d.25 frame 4 legs

code	finishing	q.kit	q.pack	a	b	c	kg.x1	vol.x1
110103-035	● nero/black	x1	150	400	530	580	3,20	mc. 0.03
110104-035	● grigio/grey	x1	150	400	530	580	3,20	mc. 0.03
110110-035	● cromato/chrome	x1	150	400	530	580	3,20	mc. 0.03

## 15 confezione puntali a testa sferica d.25 cap d.25 spherical head black package

code	finishing	q.kit	q.pack
137003-075	● nero/black	x4	120

## 05 q9-monoscocca in plastica + confezione q9-plastic shell + packaging

code	finishing	q.kit	q.pack	a	b	c	kg.x1	vol.x1
133903-007	● nero/black	x1	5	550	480	480	3,20	mc. 0.021
133905-007	○ bianco/white	x1	5	550	480	480	3,20	mc. 0.021

## 11 q9-cornice schienale in plastica per rete q9-plastic back frame for mesh

code	finishing	q.kit	q.pack	a	b	kg.x1	vol.x1
132103-060	● nero/black	x1	20	460	460	0,52	mc. 0.007
132105-011	○ bianco/white	x1	20	460	460	0,52	mc. 0.007

## 07 q9-pannello sedile in plastica da tappezzare q9-frame seat in plastic for upholstery

code	finishing	q.kit	q.pack	a	b	kg.x1	vol.x1
132203-040	● nero/black	x1	10	480	480	0,80	mc. 0.009

## 08 vite testa cilindrica a croce m6x16 zincata (per fissare scocca) screw cylindrical cross head m6x16 zinc (for fix shell)

code	finishing	q.kit
117711-191	○ zincata/zinc	x4

# q9

## 4-legs/backrest option



main component sizes

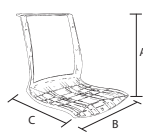

05

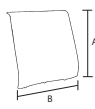

06

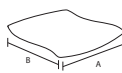

07

**05** q9-monoscocca in plastica+confezione  
q9-plastic shell + packaging

code	finishing	q.kit	q.pack	a	b	c	kg.x1	vol.x1
133903-007	● nero/black	x1	5	550	480	480	3,20	mc. 0,021
133905-007	○ bianco/white	x1	5	550	480	480	3,20	mc. 0,021

**06** q9-pannello schienale in plastica da tappezzare  
q9-frame back in plastic for upholstery

code	finishing	q.kit	q.pack	a	b	kg.x1	vol.x1
132103-061	● nero/black	x1	10	460	460	1,30	mc. 0,01
132105-012	○ bianco/white	x1	10	460	460	1,30	mc. 0,01

**07** q9-pannello sedile in plastica da tappezzare  
q9-frame seat in plastic for upholstery

code	finishing	q.kit	q.pack	a	b	kg.x1	vol.x1
132203-040	● nero/black	x1	10	480	480	0,80	mc. 0,009

**08** vite testa cilindrica a croce m6x16 zincata (per fissare scocca)  
screw cylindrical cross head m6x16 zinc (for fix shell)

code	finishing	q.kit
117711-191	○ zincata/zinc	x4

# q9 bench

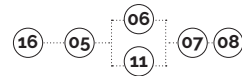

main component sizes

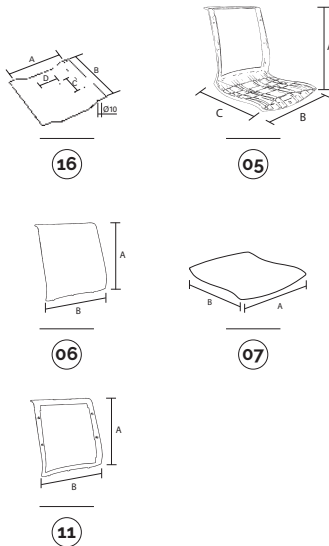

### 16 92p(01)-piastra per attacco scocca su panca 92p(01)-metal plate for shell fixing on benches

code	finishing	q.kit	q.pack	a	b	c	d	kg.x1	vol.x1
110703-013	● nero/black	x1	25	153	200	65	55	0,85	mc. 0002

### 05 q9-monoscocca in plastica+confezione q9-plastic shell + packaging

code	finishing	q.kit	q.pack	a	b	c	kg.x1	vol.x1
133903-007	● nero/black	x1	5	550	480	480	3,20	mc. 0.021
133905-007	○ bianco/white	x1	5	550	480	480	3,20	mc. 0.021

### 06 q9-pannello schienale in plastica da tappezzare q9-frame back in plastic for upholstery

code	finishing	q.kit	q.pack	a	b	kg.x1	vol.x1
132103-061	● nero/black	x1	10	460	460	1,30	mc. 0.01
132105-012	○ bianco/white	x1	10	460	460	1,30	mc. 0.01

### 11 q9-cornice schienale in plastica per rete q9-plastic back frame for mesh

code	finishing	q.kit	q.pack	a	b	kg.x1	vol.x1
132103-060	● nero/black	x1	20	460	460	0,52	mc. 0.007
132105-011	○ bianco/white	x1	20	460	460	0,52	mc. 0.007

### 07 q9-pannello sedile in plastica da tappezzare q9-frame seat in plastic for upholstery

code	finishing	q.kit	q.pack	a	b	kg.x1	vol.x1
132203-040	● nero/black	x1	10	480	480	0,80	mc. 0.009

### 08 vite testa cilindrica a croce m6x16 zincata (per fissare scocca) screw cylindrical cross head m6x16 zinc (for fix shell)

code	finishing	q.kit
117711-191	○ zincata/zinc	x4

for the bench components, see page 201

optionals

OPTIONAL  
bench  
connector



E-USB NEW  
bench plug



JIM NEW  
bench leg



APOLL  
bench arm



plastic

90GM  
bench leg



90GF  
bench leg



100GM  
bench leg



200GM  
bench leg



PIONEER  
bench arm



metal

CUT  
bench leg



SLIM  
bench leg



CUT  
bench arm



SLIM  
bench arm



aluminium







BEYOND **Logistic**

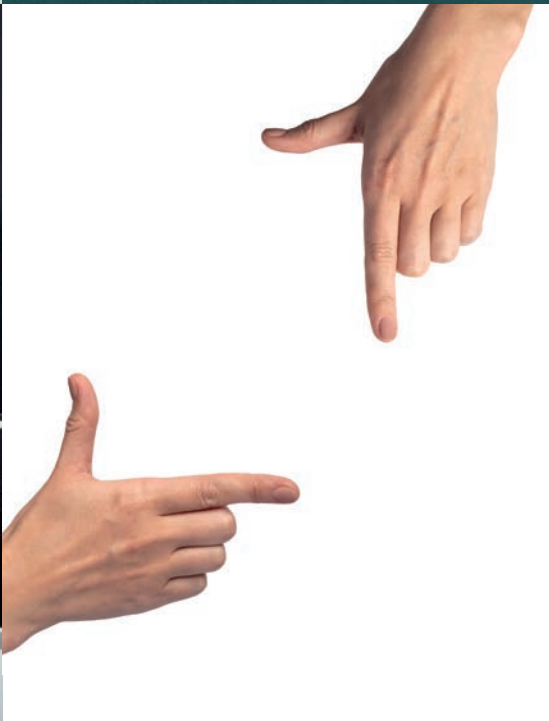





**flash**



# flash



---

side

4 legs

## flash showing

---



Una seduta **dal design moderno e geometrico** che colpisce al primo sguardo e non rinuncia al **comfort**.

Lo schienale portante in plastica può essere associato a un telaio con base a slitta o quattro gambe.

**Flash** è pensata per un utilizzo **front office**.

*The **modern, geometric design** of this chair immediately catches the eye without compromising **comfort**.*

*The supportive plastic backrest can be combined with a frame featuring a sled or four-legged base.*

**Flash** has been designed for **front office use**.

# flash

## slide

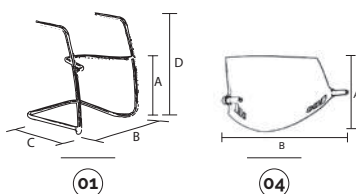

01

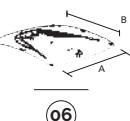

04

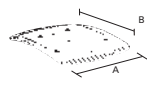

05

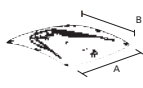

06

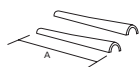

10



03



07

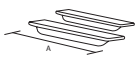

11



12

**01** flash-base a slitta in tubo d.25 tappi esclusi  
flash-slide frame pipe d.25 without caps

code	finishing	q.kit	q.pack	a	b	c	d	kg.x1	vol.x1
110503-071	● nero/black	x1	36	450	560	560	830	5,00	mc. 0.045
110504-071	● grigio/grey	x1	36	450	560	560	830	5,00	mc. 0.045
110510-071	● cromato/chrome	x1	36	450	560	560	830	5,00	mc. 0.045

**02** pinza due pioli in polietilene nera  
pliers two pin black

code	finishing	q.kit
134003-003	● nero/black	x6

**03** piedino antibaltamento in plastica nera  
plastic black feet anti-upsetting

code	finishing	q.kit	q.pack	kg.x1	vol.x1
134303-006	● nero/black	x2	100	0,025	mc. 0.0001

**04** flash-schienale in plastica  
flash-plastic back

code	finishing	q.kit	q.pack	a	b	kg.x1	vol.x1
132103-070	● nero/black	x1	10	300	480	0,90	mc. 0.01
132104-070	● grigio/grey	x1	10	300	480	0,90	mc. 0.01

**05** flash-sedile interno plastica nera  
flash-black plastic inner seat

code	finishing	q.kit	q.pack	a	b	kg.x1	vol.x1
132203-035	● nero/black	x1	10	480	460	1,10	mc. 0.045

**06** flash-sedile esterno plastica nera  
flash-black plastic external seat

code	finishing	q.kit	q.pack	a	b	kg.x1	vol.x1
132203-036	● nero/black	x1	20	450	420	0,34	mc. 0.051

**07** confezione viti tbl+ fr. d.5x14 brunita nera  
screws tbl+ fr.hilo d.5x14 zinc.black package

code	finishing	q.kit	q.pack
117003-071	● nero/black	x6	200

**08** vite 4.8tsp+m6x35 zincata  
screw 4.8tsp+m6x35 zinc

code	finishing	q.kit
117711-183	○ zincata/zinc	x4

**09** vite truciolare tsp+d.4x20 zincata (per fissaggio schienale)  
shaving screw tsp+d.4x20 zinc (for fixing back)

code	finishing	q.kit
117811-121	○ zincata/zinc	x2

**10** bracciolo destro e sinistro plastica conico  
left right black plastic conic arm

code	finishing	q.kit	q.pack	a	kg.x1	vol.x1
131703-041	● nero/black	x2	200	205	0,04	mc. 0.0002

**12** confezioni viti truciolari tsp+ d.4x25 zincate (per fissare braccioli)  
shaving screws tsp+ d.4x25 zinc package

code	finishing	q.kit	q.pack
117011-072	○ zincata/zinc	x4	200

main component sizes

optional

# flash

4-legs

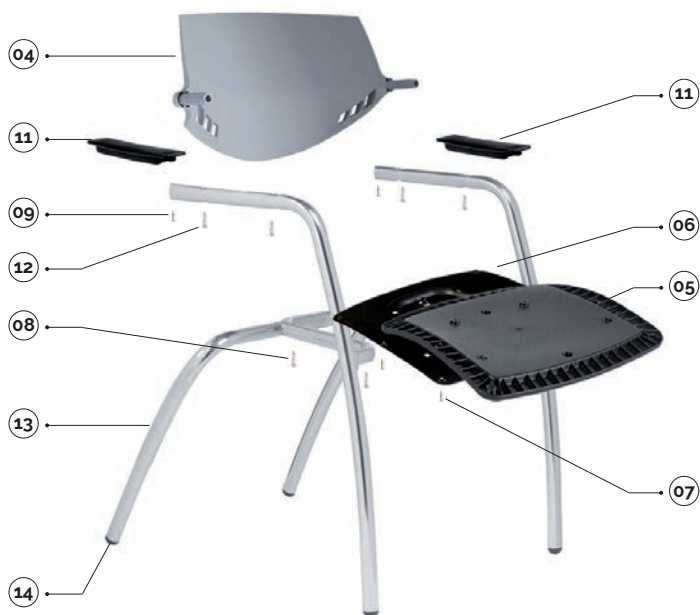

main component sizes

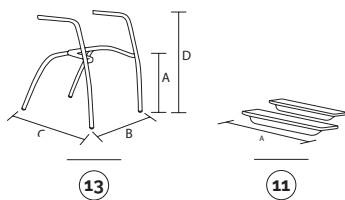

**13** flash-telaio 4 gambe con braccioli in tubo d.25 tappi esclusi  
flash-four legs frame pipe d.25 with arms without caps

code	finishing	q.kit	q.pack	a	b	c	d	kg.x1	vol.x1
110103-040	● nero/black	x1	30	450	550	570	830	3,60	mc. 0.045
110104-040	● grigio/grey	x1	30	450	550	570	830	3,60	mc. 0.045
110110-040	● cromato/chrome	x1	30	450	550	570	830	3,60	mc. 0.045

**14** confezione puntali a testa sferica d.25  
cap d.25 spherical head black package

code	finishing	q.kit	q.pack
137003-075	● nero/black	x4	120

**11** bracciolo destro e sinistro plastica nero  
left right black plastic arm

code	finishing	q.kit	q.pack	a	kg.x1	vol.x1
131703-040	● nero/black	x2	100	200	0,04	mc. 0.0004

for the components below, see page 178



optipnals



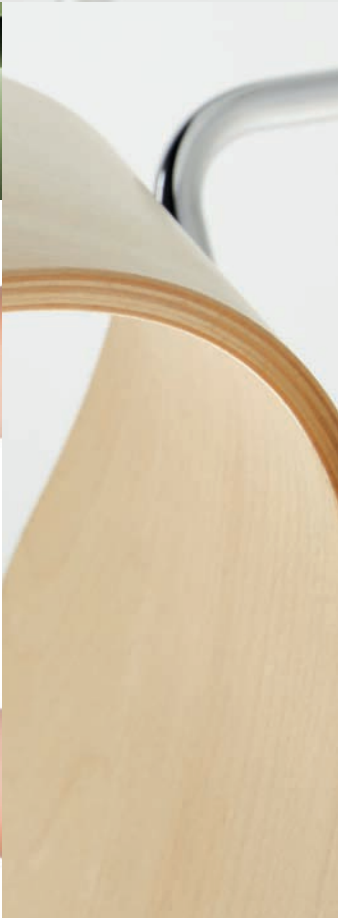
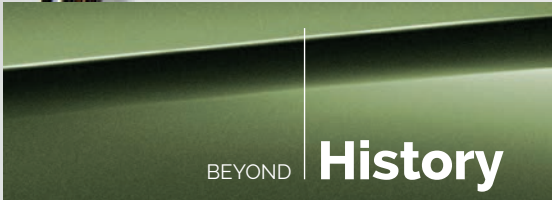



**athos**





# athos



---

4 legs

## athos showing

---



Una **scocca comoda, dal design classico ed elegante**, caratterizzata da due differenti versioni dello schienale.

La scocca è in multistrato di faggio mentre il telaio è in acciaio e disponibile in tre diverse finiture.

**Athos** si adatta principalmente all'**ambiente Home**.

*A **comfortable seat shell, boasting a classic and elegant design**, characterized by two different versions of the backrest.*

*The shell is in beech plywood while the steel frame is available in three different finishes.*

**Athos** is ideally suited to **Home environments**.

# athos

4-legs



01...02

main component sizes

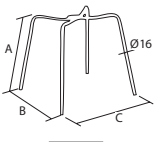

01

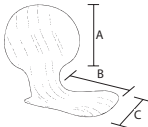

03

**01** athos-sgabello fisso senza tappi  
athos-fixed stool without caps

code	finishing	q.kit	q.pack	a	b	c	kg.x1	vol.x1
110603-060	● nero/black	x1	150	450	450	450	1,90	mc. 0,03
110604-060	● grigio/grey	x1	150	450	450	450	1,90	mc. 0,03
110610-050	● cromato/chrome	x1	150	450	450	450	1,90	mc. 0,03

**02** puntale alettato tondo ø16 nero  
ribbed round head cap ø16 black

code	finishing	q.kit
134203-160	● nero/black	x4

**03** jack-monoscocca schienale rotondo multistrato faggio spessore 10,5 mm levigato  
jack-shell round back multi-layer beechwood thickness 10,5 mm polished

code	finishing	q.kit	q.pack	a	b	c	kg.x1	vol.x1
123907-001	● faggio/beechwood	x1	10	400	420	450	2,50	mc. 0,02

**04** vite tc + m6x12 brunita nera  
screw tc + m6x12 burnishing black

code	finishing	q.kit
117703-177	● nero/black	x4

**05** protezione in pvc per scocche in legno  
pvc protection for wooden shell

code	q.kit
134006-010	x4

# athos

shell option



06



06

06 trevi-monoscocca schienale triangolare multistrato faggio spessore 10,5 mm levigato  
trevi-shell triangular back multi-layer beechwood thickness 10,5 mm polished

code	finishing	q.kit	q.pack	a	b	c	kg.x1	vol.x1
123907-002	● faggio/beechwood	x1	10	400	420	450	2,50	mc. 0,02

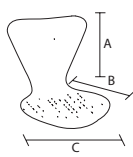

06

• optional





BEYOND **Solutions**





# components

---



# components



---

components



## components showing

---



### **Una linea completa di componenti e accessori per il mondo della seduta.**

Un grande numero di **soluzioni** in grado di rispondere in maniera completa e funzionale alle esigenze più varie: staffe porta braccioli, piastre con leva opzionabili con copertina in plastica per telaio girevole, meccanismo ribaltabile e braccioli in metallo (o plastica) per panca, tavolette dalle varie forme (in plastica o legno) con snodi anche dotati di meccanismo antipanico.

Tutti i **componenti e gli accessori AlbaComponents** garantiscono **design distintivo e tecnologia innovativa**, oltre ai più elevati standard qualitativi.

### ***A complete range of components and accessories for all types of chairs.***

*A large selection of highly functional **solutions** able to meet the most varied needs: armrest brackets, plates with optional lever and plastic cover for swivel frames, folding mechanisms and metal (or plastic) armrests for benches, writing tablets in various shapes (in plastic or wood) with swivel joints also equipped with anti-panic mechanisms.*

**All AlbaComponents components and accessories boast distinctive designs and innovative technology, as well as a guarantee of the highest quality standards.**

# components

## components

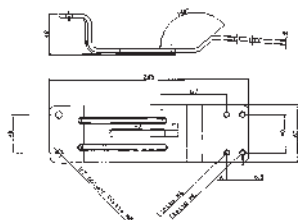

01 sb60-staffa portabracciolo  
sb60-support of arm

code	finishing	q.kit	q.pack	kg.x1	vol.x1
113003-005	● nero/black	x1	50	0,50	mc. 0.0002

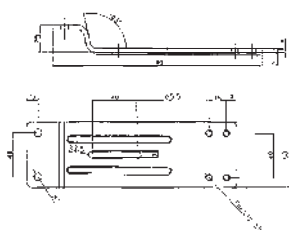

02 sb62-staffa portabracciolo  
sb62-support of arm

code	finishing	q.kit	q.pack	kg.x1	vol.x1
113003-010	● nero/black	x1	50	0,50	mc. 0.0002

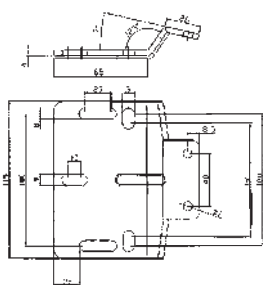

03 sb70-staffa portabracciolo  
sb70-support of arm

code	finishing	q.kit	q.pack	kg.x1	vol.x1
113003-015	● nero/black	x1	50	0,40	mc. 0.0002

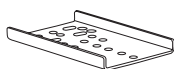

04 psal.nr-piastra adattatore per lama schienale  
psal.nr-adapter plate for blade back

code	finishing	q.kit	q.pack	kg.x1	vol.x1
113003-150	● nero/black	x1	30	0,45	mc. 0.001

# components

## components

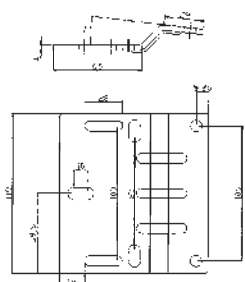

**05** sb75-staffa portabracciolo  
sb75-support of arm

code	finishing	q.kit	q.pack	kg.x1	vol.x1
113003-017	● nero/black	x1	50	0,45	mc. 0,0002

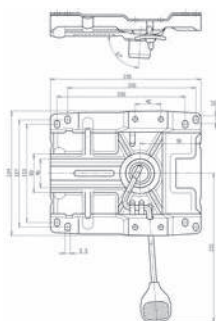

**06** piastra a gas dattilo cono 28 con leva  
seat place cone 28 with lever

code	finishing	q.kit	q.pack	kg.x1	vol.x1
113003-121	● nero/black	x1	20	1,23	mc. 0,002

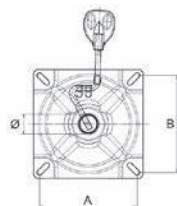

**07** pss28nr - piastra sgabello c/spat. c/28 3' l4 nera  
pss28nr - square metal plate with straight lever c/28 3' l4

code	finishing	q.kit	q.pack	a	b	ø	kg.x1	vol.x1
113003-104	● nero/black	x1	20	150	150	28	1,23	mc. 0,002



designed by:  
**stefano bettio**

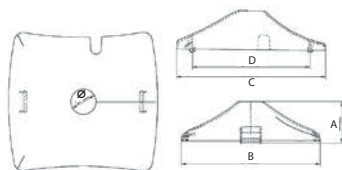

**08** cpg-copertina in plastica per telaio girevole  
cpg-plastic cover for swivel frame

code	finishing	q.kit	q.pack	a	b	c	d	ø	kg.x1	vol.x1
130903-000	● nero/black	x1	50	60	200	210	167	36	0,1	mc. 0,0015

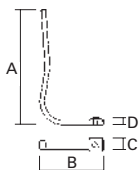

**09** sh15-schienale in tubo ovale con cavalotto di rinforzo filettato  
sh15-oval back with reinforcement threading black painted

code	finishing	q.kit	q.pack	a	b	c	d	kg.x1	vol.x1
112103-001	● nero/black	x1	50	330	215	30	15	0,62	mc. 0,0008

# components

## components

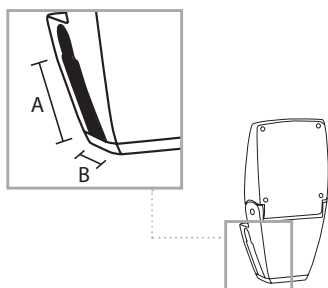

**10** siton-mecanismo panca ribaltabile alluminio lucido  
siton-polished aluminium folding mechanism

code	finishing	q.kit	q.pack	a	b	kg.x1	vol.x1
110704-180	o alluminio/aluminium	x1	4	80	40	2,81	mc. 0,007



designed by:  
**esedra**

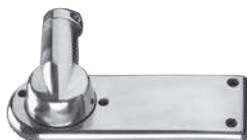

**11** spta-snodo tavoletta antipanico in alluminio lucido  
spta-polished aluminium swivel safety mechanism for tablet

code	finishing		q.kit	q.pack	a	b	c	kg.x1	vol.x1
111701-900	o alluminio/aluminium	destro/right	x1	10	180	66	15x15	0,365	mc. 0,001
111701-901	o alluminio/aluminium	sinistro/left	x1	10	180	66	15x15	0,365	mc. 0,001

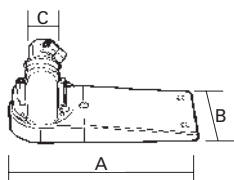

**12** sptz-snodo per tavoletta in termoplastica  
sptz-mechanism for writing tablet

code	finishing	q.kit	q.pack	a	b	c	kg.x1	vol.x1
134003-039	● nero/black	x1	20	180	66	15x15	0,35	mc. 0,0006

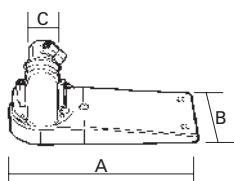

**13** isoscele-aggancio laterale maschio + femmina in plastica con due viti  
isoscele-plastic lateral hook male + female with 2 screws

code	finishing	q.kit	q.pack
134003-132	● nero/black	x2	100



# components

## components

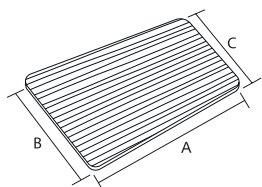

**14** tlo2.cfd-tavoletta legno c/prefori dx verniciata faggio  
tlo2.cfd-right painted beechwood tablet

code	finishing	q.kit	q.pack	a	b	c	kg.x1	vol.x1
120307-021	● faggio/beech	x1	10	342	245	196	0,65	mc. 0,009

tlo2.cfs-tavoletta legno c/prefori sx verniciata faggio  
tlo2.cfs-left painted beechwood tablet

code	finishing	q.kit	q.pack	a	b	kg.x1	vol.x1
120307-022	● faggio/beech	x1	10	342	245	196	0,65 mc. 0,009

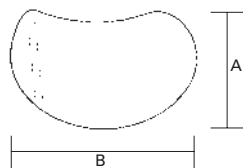

**15** bean-tavoletta in termoplastico spessore 16 mm  
bean-writing tablet in plastic thickness 16 mm

code	finishing	q.kit	q.pack	a	b	kg.x1	vol.x1
134003-044	● nero/black	x1	20	235	370	0,40	mc. 0,002

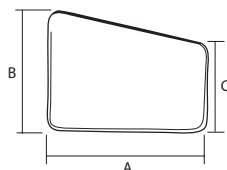

**16** tlt-tavoletta in termoplastico spessore 16 mm  
tlt-writing tablet in plastic thickness 16 mm

code	finishing	q.kit	q.pack	a	b	c	kg.x1	vol.x1
134003-042	● nero/black	x1	20	345	260	200	0,40	mc. 0,002

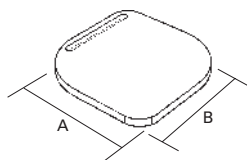

**17** tlt2-tavoletta in termoplastico ovale spessore 16 mm per bracciolo destro e sinistro  
tlt2-writing tablet in oval plastic thickness 16 mm for left and right arms

code	finishing	q.kit	q.pack	a	b	kg.x1	vol.x1
134003-040	● nero/black	x1	20	271	271	0,40	mc. 0,002

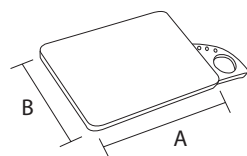

**18** tlt3-tavoletta ambidestro con portabicchiere e portapenne  
tlt3-writing tablet with cup holder and pen tray

code	finishing	q.kit	q.pack	a	b	kg.x1	vol.x1
134003-041	● nero/black	x1	10	370	255	1,05	mc. 0,036

# bench components

components



designed by:  
r&d albacomponents

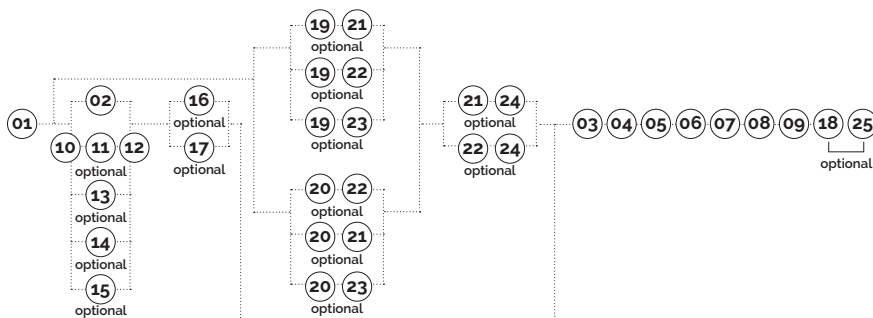
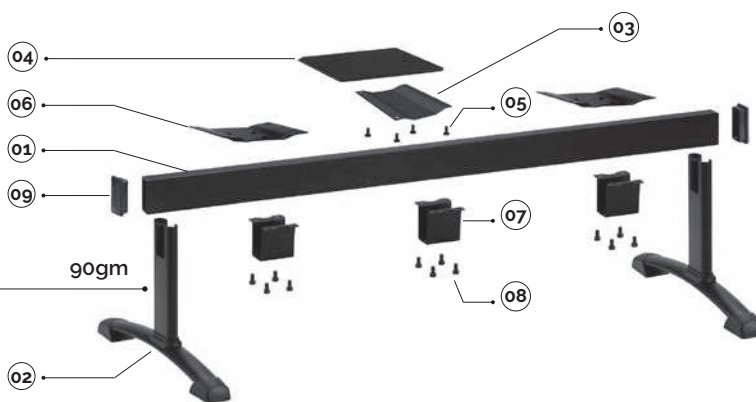

main component sizes

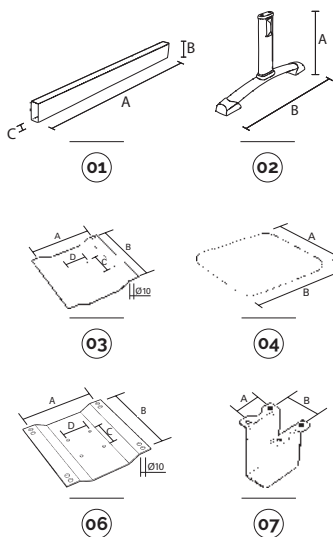

## 01 90t-trave per panca 90t-beam for bench

code	finishing		q.kit	q.pack	a	b	c	kg.x1	vol.x1
110703-020	● nero/black	2 posti/2 seats	x1	1	1000	80	40	2,80	mc. 0,003
110704-043	● grigio/grey	2 posti/2 seats	x1	1	1000	80	40	2,80	mc. 0,003
110703-021	● nero/black	3 posti/3 seats	x1	1	1500	80	40	4,20	mc. 0,0045
110704-044	● grigio/grey	3 posti/3 seats	x1	1	1500	80	40	4,20	mc. 0,0045
110703-022	● nero/black	4 posti/4 seats	x1	1	2000	80	40	5,60	mc. 0,006
110704-045	● grigio/grey	4 posti/4 seats	x1	1	2000	80	40	5,60	mc. 0,006
110703-023	● nero/black	5 posti/5 seats	x1	1	2500	80	40	7,00	mc. 0,0085
110704-046	● grigio/grey	5 posti/5 seats	x1	1	2500	80	40	7,00	mc. 0,0085

## 02 90gm-gamba mobile per panca con accessori 90gm-movable leg for bench with accessories

code	finishing		q.kit	q.pack	a	b	kg.x1	vol.x1
110703-005	● nero/black		x2	2	380	600	2,70	mc. 0,012
110704-001	● grigio/grey		x2	2	380	600	2,70	mc. 0,012
110710-001	● cromato/chrome		x2	2	380	600	2,70	mc. 0,012

## 03 90ap-attacco porta piano 90ap-table attachment

code	finishing		q.kit	q.pack	a	b	c	d	kg.x1	vol.x1
110703-014	● nero/black		x1	25	170	200	65	55	1,00	mc. 0,0002
110704-019	● grigio/grey		x1	25	170	200	65	55	1,00	mc. 0,0002

## 04 90tn-piano tavolo per panca 90tn-table for bench

code	finishing		q.kit	q.pack	a	b	kg.x1	vol.x1
120303-001	● nero/black		x1	10	400	400	2,20	mc. 0,002

## 05 vite tc + m6x12 brunita nera screw tc + m6x12 burnishing black

code	finishing		q.kit
117703-177	● nero/black		x4

## 06 92p-piastra per panca verniciata 92p-plate for bench paint

code	finishing		q.kit	q.pack	a	b	c	d	kg.x1	vol.x1
110703-013	● nero/black		x1	25	153	200	65	55	0,85	mc. 0,0008

## 07 90cv-cavalotto sotto trave 90cv-support under beam

code	finishing		q.kit	q.pack	a	b	kg.x1	vol.x1
110703-007	● nero/black		x1	50	55	65	0,60	mc. 0,0005
110704-015	● grigio/grey		x1	50	55	65	0,60	mc. 0,0005

## 08 confezione vite m8x12 testa cilindrica esagonale incassato brunita nera screw m8x12 cylindrical head hexagon embedded burnishing black package

code	finishing		q.kit	q.pack
117003-070	● nero/black		x4	200

## 09 tappo copritesta rettangolare 80x40 nero rectangular cover head cap 80x40 black

code	finishing		q.kit
134103-001	● nero/black		x2

# bench leg & arm options

## components

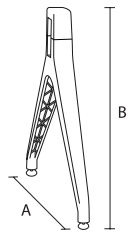

certification / Jim



EN16139

- 10 jim-gamba in plastica nera  
jim-plastic bench leg\_black

code	finishing	q.kit	q.pack	a	b	kg.x1	vol.x1
130703-004	● nero/black	x2	10	630	425	0,95	mc. 0,0102

- 11 jim-cavalotto x fissaggio gamba nero in plastica  
jim-plastic bracket for bench leg - black

code	finishing	q.kit	q.pack	kg.x1	vol.x1
130703-005	● nero/black	x2	10	0,16	mc. 0,0005

- 12 jim-confezione accessori x 10 gambe  
jim- accessories bag for 10 legs

code	finishing	q.kit	q.pack	kg.x1	vol.x1
130703-007	● nero/black	x0.2	1	0,15	mc. 0,0004

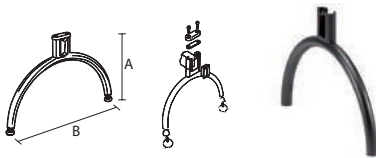

- 13 100gm-gamba mobile per panca con accessori  
100gm-movable leg for bench with accessories

code	finishing	q.kit	q.pack	a	b	kg.x1	vol.x1
110703-008	● nero/black	x2	2	380	600	2,10	mc. 0,012
110704-006	● grigio/grey	x2	2	380	600	2,10	mc. 0,012
110710-005	● cromato/chrome	x2	2	380	600	2,10	mc. 0,012

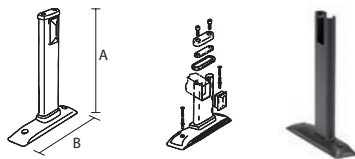

- 14 90gf-gamba fissa per panca con accessori  
90gf-fixed leg for bench with accessories

code	finishing	q.kit	q.pack	a	b	kg.x1	vol.x1
110703-030	● nero/black	x2	2	380	310	1,90	mc. 0,012
110704-012	● grigio/grey	x2	2	380	310	1,90	mc. 0,012

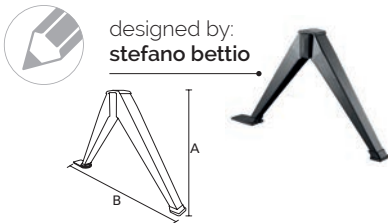

- 15 200gm-gamba mobile per panca con accessori  
200gm-movable leg for bench with accessories

code	finishing	q.kit	q.pack	a	b	kg.x1	vol.x1
110703-110	● nero/black	x2	4	380	600	2,60	mc. 0,005
110704-110	● grigio/grey	x2	4	380	600	2,60	mc. 0,005
110710-110	● cromato/chrome	x2	4	380	600	2,60	mc. 0,005

designed by:  
stefano bettio

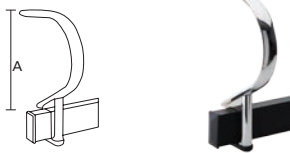

- 16 pioneer-bracciolo ellittico 40x20 per panca con accessori  
pioneer-elliptical 40x20 arm for bench with accessories

code	finishing	q.kit	q.pack	a	kg.x1	vol.x1
111703-015	● nero/black	x1	5	260	1,10	mc. 0,005
111704-015	● grigio/grey	x1	5	260	1,10	mc. 0,005
111710-015	● cromato/chrome	x1	5	260	1,10	mc. 0,005

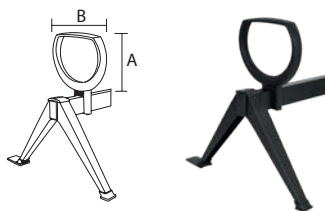

- 17 apoll-bracciolo in plastica + cavallotto per panca  
apoll-plastic arm + support for bench

code	finishing	q.kit	q.pack	a	b	kg.x1	vol.x1
131703-065	● nero/black	x1	10	275	300	0,90	mc. 0,008

- 18 connettore trave panca  
beam bench connector

code	finishing	q.kit	q.pack	a	b	kg.x1
110703-025	● nero/black	x1	10	75	36 400	1,42

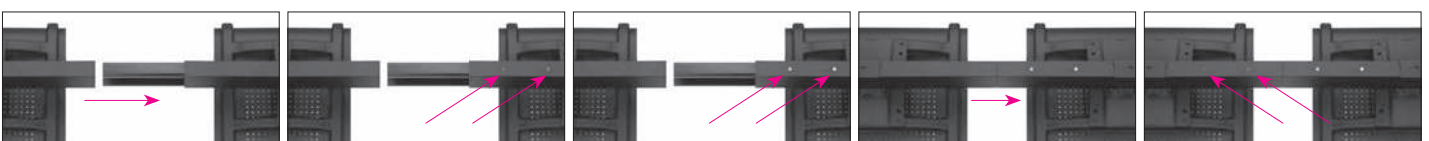
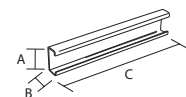

01

02

03

04

05



# bench leg & arm options

components / cut & slim options



designed by:  
**alessandro crosera**

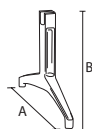

**19** cut-gamba in alluminio per gamba panca + n°2 piedini  
cut-aluminium leg for bench + n°2 glides

code	finishing	q.kit	q.pack	a	b	kg.x1	vol.x1
111704-224	⊖ alluminio/aluminium	x2	5	610	350	2,75	mc. 0.0132

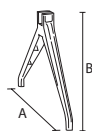

**20** slim-gamba in alluminio per gamba panca + n°2 piedini  
slim-aluminium leg for bench + n°2 glides

code	finishing	q.kit	q.pack	a	b	kg.x1	vol.x1
111704-226	⊖ alluminio/aluminium	x2	5	610	350	1,3125	mc. 0.0102



**21** cut-bracciolo in alluminio per panca + n°2 viti  
cut- aluminium arm for bench + n°2 screws

code	finishing	q.kit	q.pack	a	b	kg.x1	vol.x1
111704-223	⊖ alluminio/aluminium	x1	10	300	305	1,6065	mc. 0.0028



**22** slim-bracciolo in alluminio per panca + n°2 viti  
slim- aluminium arm for bench + n°2 screws

code	finishing	q.kit	q.pack	a	b	kg.x1	vol.x1
111704-225	⊖ alluminio/aluminium	x1	10	325	305	1,464	mc. 0.0049



**23** cut/slim-cavalotto in alluminio per gamba panca + n°2 viti  
cut/slim aluminium bracket 80x40 for bench leg + n°2 screws

code	finishing	q.kit	q.pack	a	b	kg.x1	vol.x1
111704-222	⊖ alluminio/aluminium	x2	10	60	95	0,30	mc. 0.0005

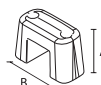

**24** cut/slim-cavalotto in alluminio per bracciolo panca  
cut/slim aluminium bracket 80x40 for bench arm

code	finishing	q.kit	q.pack	a	b	kg.x1	vol.x1
111704-221	⊖ alluminio/aluminium	x1	10	58	95	0,38	mc. 0.0005

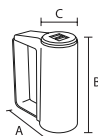

**25** e:usb-caricatore per panca  
e:usb-bench plug

code	finishing	q.kit	q.pack	a	b	c	kg.x1	vol.x1
130703-002	● nero/black	x1	5	85	100	38	0,28	mc. 0.0009

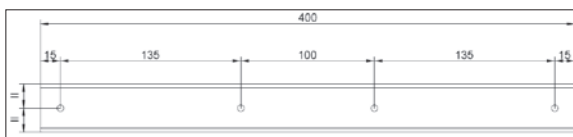
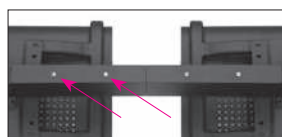

trama di foratura consigliata, lato inferiore trave  
hole pattern suggested, underneath side of the beam

O R I G I N A L L Y

Catalogue  
2021

albacomponents

**art direction & design**

sevenmedialab

**photo**

photopiù

**print**

graficasette



download here  
**Originally Catalogue**

**alba**components



| [albacomponents.it](http://albacomponents.it)

**AlbaComponents by Metalmeccanica Alba srl**

via Boschier, 54/A  
Loc. Ca' Rainati  
31020 San Zenone degli Ezzelini  
TREVISO (Italy)

Tel. +39.0423.969700 r.a.  
Fax +39.0423.964014  
[info@albacomponents.it](mailto:info@albacomponents.it)  
[www.albacomponents.it](http://www.albacomponents.it)