



90



90



side

4 legs

4 legs w/armrests

4 legs w/writing tablet

swivel

bench



EN 1728

90 showing



tools



certification



La **serie 90** è caratterizzata da un **design classico** e dalla riconosciuta **qualità AlbaComponents**.

Un **ampio assortimento di telai e componenti** completano l'offerta di un prodotto essenziale e versatile, capace di soddisfare ogni esigenza negli ambiti più diversi, rendendola una sedia dai grandi numeri.
Certificata CATAS.

***Serie 90** is characterized by a **classic design** and **famed AlbaComponents quality**.*

*A **wide assortment of frames and components** complete the options available for this essential and versatile product. It caters for a broad range of needs in the most diverse settings, making it a very popular chair.
CATAS certified.*

90

4-legs

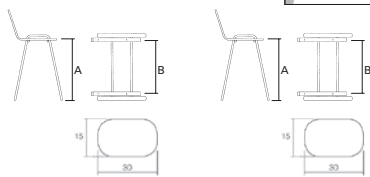
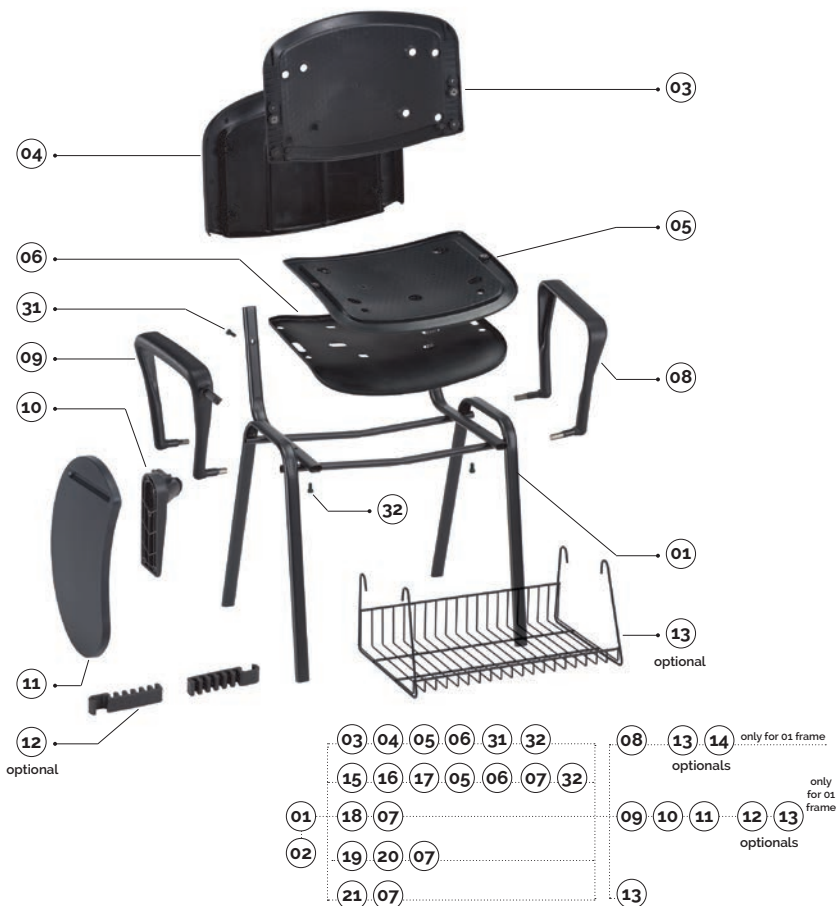

01

02

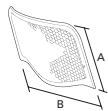

03

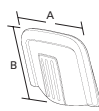

04

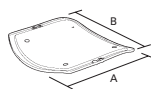

05

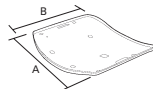

06

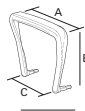

08

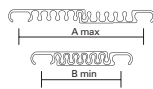

12



14



aggancio laterale maschio+femmina
in plastica con 2 viti
plastic lateral hook male+female
with 2 screws
134003-132

01 g2-telaio per sedia in tubo ovale 30x15 con tappi laterali e sottopiede montati

g2-chair frame in 30x15 oval tube with side and foot caps mounted

code	finishing	arm attach	q.kit	q.pack	a	b	kg.x1	vol.x1
112003-005	● nero/black	12	x1	160	450	425	3,00	mc. 0.021
112003-004	● nero/black	14	x1	160	450	425	3,00	mc. 0.021
112004-000	● grigio/grey	12	x1	160	450	425	3,00	mc. 0.021
112004-002	● grigio/grey	14	x1	160	450	425	3,00	mc. 0.021
112010-008	● cromato/chrome	12	x1	160	450	425	3,00	mc. 0.021
112010-005	● cromato/chrome	14	x1	160	450	425	3,00	mc. 0.021

02 g2-telaio per sedia in tubo ovale 30x15 con aggancio laterale in metallo saldato, con tappi laterali e sottopiede montati

g2-chair frame in 30x15 oval tube with metal lateral hook welded, side and foot caps mounted

code	finishing	arm attach	q.kit	q.pack	a	b	kg.x1	vol.x1
112003-016	● nero/black	12	x1	160	450	425	3,00	mc. 0.021
112003-015	● nero/black	14	x1	160	450	425	3,00	mc. 0.021
112004-007	● grigio/grey	12	x1	160	450	425	3,00	mc. 0.021
112004-008	● grigio/grey	14	x1	160	450	425	3,00	mc. 0.021
112010-016	● cromato/chrome	12	x1	160	450	425	3,00	mc. 0.021
112010-015	● cromato/chrome	14	x1	160	450	425	3,00	mc. 0.021

03 goshi-schienale interno in plastica

goshi-inner plastic back

code	finishing	q.kit	q.pack	a	b	kg.x1	vol.x1
132103-002	● nero/black	x1	40	330	470	0,60	mc. 0.004

04 goshe-coprischiena esterno in plastica

goshe-outer plastic back

code	finishing	q.kit	q.pack	a	b	kg.x1	vol.x1
132103-001	● nero/black	x1	30	475	335	0,40	mc. 0.004

05 gosdi-sedile interno in plastica

gosdi-inner plastic seat

code	finishing	q.kit	q.pack	a	b	kg.x1	vol.x1
132203-002	● nero/black	x1	30	460	400	0,80	mc. 0.004

06 gosde-sottosedile esterno plastica

gosde-outer plastic seat

code	finishing	q.kit	q.pack	a	b	kg.x1	vol.x1
132203-001	● nero/black	x1	80	410	465	0,40	mc. 0.003

31 vite tsp+ m6x20 zincata bianca

screw tsp+ m6x20 white zinc

code	finishing	q.kit
117711-203	● zincata bianca/white zinc	x2

32 vite tsp+ m6x25 zincata bianca

screw tsp+ m6x25 white zinc

code	finishing	q.kit
117711-199	● zincata bianca/white zinc	x2

08 gob-bracciolo in nylon

gob-nylon armrest

code	finishing	arm attach	q.kit	q.pack	a	b	c	kg.x1	vol.x1
131703-002	● nero/black	14	x2	20	290	250	190	0,80	mc. 0.0026
131703-004	● nero/black	12	x2	20	290	250	190	0,80	mc. 0.0026

12 coppia pinze regolabili per tubo ovale 15x30 pp

clips for oval tube 15x30 pp

code	finishing	q.kit	q.pack	a	b
134003-002	● nero/black	x1	200	214	134

13 g2c-cestello portariviste

g2c-magazine rack

code	finishing	q.kit	q.pack	kg.x1	vol.x1
113403-001	● nero/black	x1	25	0,975	mc. 0.03
113410-020	● cromato/chrome	x1	25	0,975	mc. 0.03

main component sizes

optionals

90

4-legs/tablet accessories

main component sizes



09

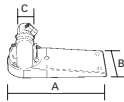

10

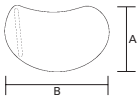

11

- 09 gobp-bracciolo in nylon con aggancio porta tavoletta
gobp-nylon armrest with writing tablet hook

code	finishing	arm attach	q.kit	q.pack	a	b	c	d	kg.x1	vol.x1
131703-001	● nero/black	14	x1	20	290	250	190	15x15	0,80	mc. 0,0026
131703-003	● nero/black	12	x1	20	290	250	190	15x15	0,80	mc. 0,0026

- 10 sp22-snodo per tavoletta in termoplastica
sp22-thermoplastic writing tablet articulation

code	finishing	q.kit	q.pack	a	b	c	kg.x1	vol.x1
134003-039	● nero/black	x1	20	180	66	15x15	0,35	mc. 0,0006

- 11 bean-tavoletta in termoplastico spessore 16 mm
bean-16mm thick thermoplastic writing tablet

code	finishing	q.kit	q.pack	a	b	kg.x1	vol.x1
134003-044	● nero/black	x1	20	235	370	0,40	mc. 0,002

TLT tablet TLT2 tablet TLT3 tablet BEAN tablet TL02 tablet SPT2 mechanism tablet SPTA mechanism antipanico



for writing tablet options, see page 192/193

4-legs/backrest and seat options

main component sizes

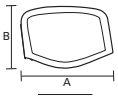

15

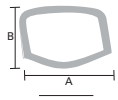

16

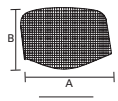

17



- 15 isonet-telaio schienale in plastica con viti per rete
isonet-outer frame with screws for net

code	finishing	q.kit	q.pack	a	b	kg.x1	vol.x1
132103-003	● nero/black	x1	25	470	345	0,42	mc. 0,006

- 16 isonet-cornice schienale in plastica per rete
isonet-open frame for isonet model

code	finishing	q.kit	q.pack	a	b	kg.x1	vol.x1
132103-004	● nero/black	x1	25	470	345	0,31	mc. 0,004

- 17 isonet-rete per schienale
isonet-net for back

code	finishing	q.kit	q.pack	a	b	kg.x1	vol.x1
132105-500	○ bianco/white	x1	25	550	400	0,14	mc. 0,0057
132103-500	● nero/black	x1	25	550	400	0,14	mc. 0,0057
132102-500	● rosso/red	x1	25	550	400	0,14	mc. 0,0057

- 07 vite testa svasata croce m6x18 brunita nera-fissaggio sedile/ schienale faggio
m6x18 black burnished flared philips screw-beech seat/backrest fixing

code	finishing	q.kit
117703-195	● nero/black	x4

and · 05 06 32

- 18 novx-sedile e schienale in plastica disponibili per telaio in tubo ovale e in tubo ellittico
novx-plastic seat and backrest available for oval or elliptic tube frame

code	finishing	q.kit	q.pack	a	b	c	d	kg.x1	vol.x1
134002-001	● rosso/red	x1	20	470	315	460	400	1,21	mc. 0,008
134003-119	● nero/black	x1	20	470	315	460	400	1,21	mc. 0,008
134015-003	● blu/blue	x1	20	470	315	460	400	1,21	mc. 0,008

and · 07

- 19 prisma-schienale e sedile in plastica disponibili per telaio in tubo ovale e in tubo ellittico
prisma-plastic backrest and seat available for oval or elliptic tube frame

code	finishing	q.kit	q.pack	a	b	c	d	kg.x1	vol.x1
134003-110	● nero/black	x1	10	470	330	460	430	1,60	mc. 0,016

- 20 prisma-pannello sedile da tappezzare
prisma-seat panel to upholster

code	finishing	q.kit	q.pack	a	b	kg.x1	vol.x1
132203-010	● nero/black	x1	20	400	400	0,40	mc. 0,004

and · 07

- 21 goshsdlf-schienale + sedile multistrato verniciato faggio + 4 testine
goshsdlf-backrest + seat in painted planed beech plywood

code	finishing	q.kit	q.pack	a	b	c	d	e	f	kg.x1	vol.x1
124007-000	● faggio/beech-wood	x1	10	325	465	415	460	10	10	2,70	mc. 0,07

and · 07

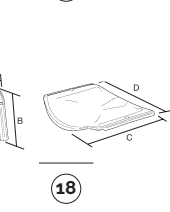

18

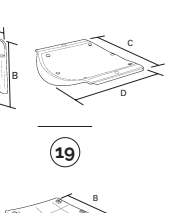

19

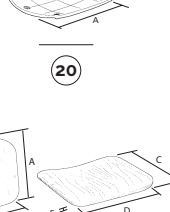

21



90

4-legs w/armrests

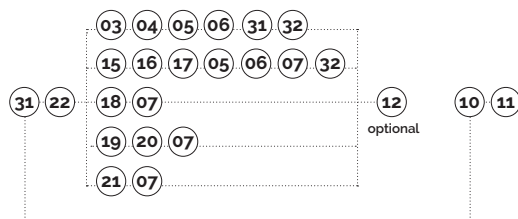

main component sizes

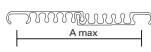
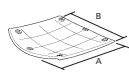
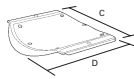
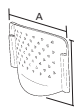
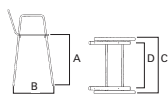

22

19

20

12

22 g4-telaio per sedia in tubo ovale 30x15 con braccioli con tappi laterali e sottopiede montati
g4-chair frame in 30x15 oval tube with armrests, side and foot caps mounted

code	finishing	q.kit	q.pack	a	b	c	d	kg.x1	vol.x1
112003-020	● nero/black	x1	80	450	470	545	425	3,80	mc. 0,042
112004-021	● grigio/grey	x1	80	450	470	545	425	3,80	mc. 0,042
112010-040	● cromato/chrome	x1	80	450	470	545	425	3,80	mc. 0,042

19 prisma-schienale e sedile in plastica disponibili per telaio in tubo ovale e in tubo ellittico
prisma-plastic backrest and seat available for oval or elliptic tube frame

code	finishing	q.kit	q.pack	a	b	c	d	kg.x1	vol.x1
134003-110	● nero/black	x1	10	470	330	460	430	1,60	mc. 0,016

20 prisma-pannello sedile da tappezzare
prisma-seat panel to upholster

code	finishing	q.kit	q.pack	a	b	kg.x1	vol.x1
132203-010	● nero/black	x1	20	400	400	0,40	mc. 0,004

07 vite testa svasata croce m6x18 brunita nera-fissaggio sedile/ schienale faggio
m6x18 black burnished flared philips screw-beech seat/backrest fixing

code	finishing	q.kit
117703-195	● nero/black	x4

12 coppia pinze regolabili per tubo ovale 15x30 pp
clips for oval tube 15x30 pp

code	finishing	q.kit	q.pack	a	b
134003-002	● nero/black	x1	200	214	134

90

4-legs with armrests/tablet accessories

main component sizes

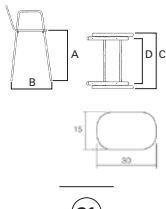

aggancio tavoletta
tablet hook

31

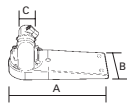

10

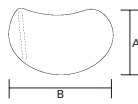

11

- 31 94-telaio per sedia in tubo ovale 30x15 con braccioli per tavoletta
94-chair frame in 30x15 oval tube with armrests for writing tablet

code	finishing	q.kit	q.pack	a	b	c	d	kg.x1	vol.x1
112003-022	● nero/black	x1	80	450	470	545	425	3,80	mc. 0.042
112004-022	● grigio/grey	x1	80	450	470	545	425	3,80	mc. 0.042
112010-043	● cromato/chrome	x1	80	450	470	545	425	3,80	mc. 0.042

- 10 spt2-snodo per tavoletta in termoplastica
spt2-thermoplastic writing tablet articulation

code	finishing	q.kit	q.pack	a	b	c	kg.x1	vol.x1
134003-039	● nero/black	x1	20	180	66	15x15	0,35	mc. 0.0006

- 11 bean-tavoletta in termoplastico spessore 16 mm
bean-16mm thick thermoplastic writing tablet

code	finishing	q.kit	q.pack	a	b	kg.x1	vol.x1
134003-044	● nero/black	x1	20	235	370	0,40	mc. 0.002

TLT tablet TLT2 tablet TLT3 tablet BEAN tablet TL02 tablet SPT2 mechanism tablet SPTA mechanism antipanic



for writing tablet options, see page 192/193

4-legs with armrests/backrest and seat options

main component sizes

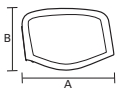

15

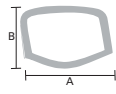

16

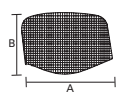

17



- 15 isonet-telaio schienale in plastica con viti per rete
isonet-outer frame with screws for net

code	finishing	q.kit	q.pack	a	b	kg.x1	vol.x1
132103-003	● nero/black	x1	25	470	345	0,42	mc. 0.006

- 16 isonet-cornice schienale in plastica per rete
isonet-open frame for isonet model

code	finishing	q.kit	q.pack	a	b	kg.x1	vol.x1
132103-004	● nero/black	x1	25	470	345	0,31	mc. 0.004

- 17 isonet-rete per schienale
isonet-net for back

code	finishing	q.kit	q.pack	a	b	kg.x1	vol.x1
132105-500	○ bianco/white	x1	25	550	400	0,14	mc. 0.0057
132103-500	● nero/black	x1	25	550	400	0,14	mc. 0.0057
132102-500	● rosso/red	x1	25	550	400	0,14	mc. 0.0057

and · 05 06 07 32

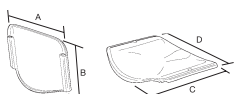

18



- 18 novx-sedile e schienale in plastica disponibili per telaio in tubo ovale e in tubo ellittico
novx-plastic seat and backrest available for oval or elliptic tube frame

code	finishing	q.kit	q.pack	a	b	c	d	kg.x1	vol.x1
134002-001	● rosso/red ral3002	x1	20	470	315	460	400	1,21	mc. 0.008
134003-119	● nero/black ral9005	x1	20	470	315	460	400	1,21	mc. 0.008
134015-003	● blu/blue ral5002	x1	20	470	315	460	400	1,21	mc. 0.008

and · 07



03



- 03 goshi-schienale interno in plastica
goshi-inner plastic back

code	finishing	q.kit	q.pack	a	b	kg.x1	vol.x1
132103-002	● nero/black	x1	40	330	470	0,60	mc. 0.004

- 04 goshe-coprischienale esterno in plastica
goshe-outer plastic back

code	finishing	q.kit	q.pack	a	b	kg.x1	vol.x1
132103-001	● nero/black	x1	30	475	335	0,40	mc. 0.004

and · 05 06 31 32

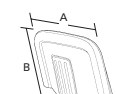

04

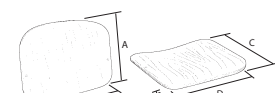

21



- 21 goshsdlf-schienale + sedile multistrato verniciato faggio + 4 testine
goshsdlf-backrest + seat in painted planed beech plywood

code	finishing	q.kit	q.pack	a	b	c	d	e	f	kg.x1	vol.x1
124007-000	● faggio/beech-wood	x1	10	325	465	415	460	10	10	2,70	mc. 0.07

and · 07

90 slide

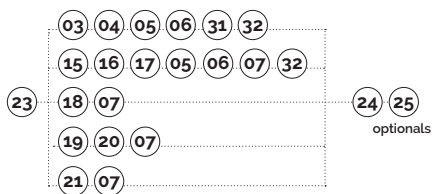
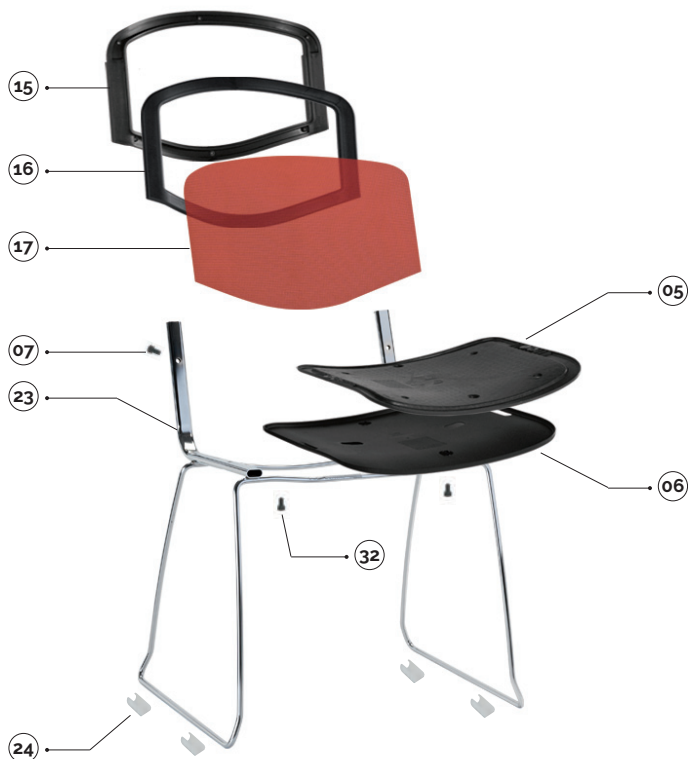

main component sizes

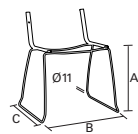

23

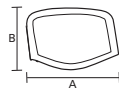

15

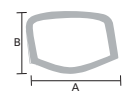

16

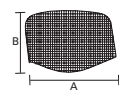

17

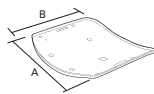

05

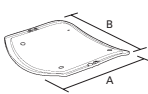

06



24



25

optionals

23 spritz-telaio chiuso in tondino d.11 tappi esclusi
spritz-sled wire frame d.11 caps excluded

code	finishing	q.kit	q.pack	a	b	c	kg.x1	vol.x1
112010-250	● cromato/chrome	x1	100	450	580	470	4,00	mc. 0,042

24 confezione di basi a pinza antirotazione per tondino colore neutro
neutral clips base for wire d.11 package

code	finishing	q.kit	q.pack
137006-070	○ neutro/neutral	x4	200

25 base piana a pinza doppia
double flat clip base

code	finishing	q.kit
134006-021	○ neutro/neutral	x4

15 isonet-telaio schienale in plastica con viti per rete
isonet-outer frame with screws for net

code	finishing	q.kit	q.pack	a	b	kg.x1	vol.x1
132103-003	● nero/black	x1	25	470	345	0,42	mc. 0,006

16 isonet-cornice schienale in plastica per rete
isonet-open frame for isonet model

code	finishing	q.kit	q.pack	a	b	kg.x1	vol.x1
132103-004	● nero/black	x1	25	470	345	0,31	mc. 0,004

17 isonet-rete per schienale
isonet-net for back

code	finishing	q.kit	q.pack	a	b	kg.x1	vol.x1
132105-500	○ bianco/white	x1	25	550	400	0,14	mc. 0,0057
132103-500	● nero/black	x1	25	550	400	0,14	mc. 0,0057
132102-500	● rosso/red	x1	25	550	400	0,14	mc. 0,0057

05 gosdi-sedile interno in plastica
gosdi-inner plastic seat

code	finishing	q.kit	q.pack	a	b	kg.x1	vol.x1
132203-002	● nero/black	x1	30	460	400	0,80	mc. 0,004

06 gosde-sottosedile esterno plastica
gosde-outer plastic seat

code	finishing	q.kit	q.pack	a	b	kg.x1	vol.x1
132203-001	● nero/black	x1	80	410	465	0,40	mc. 0,003

07 vite testa svasata croce m6x18 brunita nera-fissaggio sedile/ schienale faggio
m6x18 black burnished flared philips screw-beech seat/backrest fixing

code	finishing	q.kit
117703-195	● nero/black	x4

32 vite tsp+ m6x25 zincata bianca
screw tsp+ m6x25 white zinc

code	finishing	q.kit
117711-199	● zincata bianca/white zinc	x2

90

slide/backrest and seat options

main component sizes

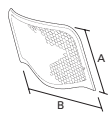

03

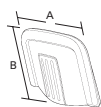

04



03 goshi-schienale interno in plastica goshi-inner plastic back

code	finishing	q.kit	q.pack	a	b	kg.x1	vol.x1
132103-002	● nero/black	x1	40	330	470	0,60	mc. 0,004

04 goshe-coprischienale esterno in plastica goshe-outer plastic back

code	finishing	q.kit	q.pack	a	b	kg.x1	vol.x1
132103-001	● nero/black	x1	30	475	335	0,40	mc. 0,004

and · 05 06 31 32

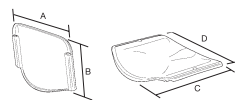

18



18 novx-sedile e schienale in plastica disponibili per telaio in tubo ovale e in tubo ellittico novx-plastic seat and backrest available for oval or elliptic tube frame

code	finishing	q.kit	q.pack	a	b	c	d	kg.x1	vol.x1
134002-001	● rosso/red ral3002	x1	20	470	315	460	400	1,21	mc. 0,008
134003-119	● nero/black ral9005	x1	20	470	315	460	400	1,21	mc. 0,008
134015-003	● blu/blue ral5002	x1	20	470	315	460	400	1,21	mc. 0,008

and · 07

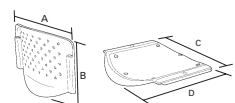

19



19 prisma-schienale e sedile in plastica disponibili per telaio in tubo ovale e in tubo ellittico prisma-plastic backrest and seat available for oval or elliptic tube frame

code	finishing	q.kit	q.pack	a	b	c	d	kg.x1	vol.x1
134003-110	● nero/black	x1	10	470	330	460	430	1,60	mc. 0,016

20 prisma-pannello sedile da tappezzare prisma-seat panel to upholster

code	finishing	q.kit	q.pack	a	b	kg.x1	vol.x1
132203-010	● nero/black	x1	20	400	400	0,40	mc. 0,004

and · 07

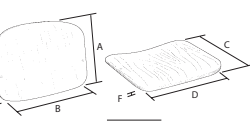

21



21 goshsdlf-schienale + sedile multistrato verniciato faggio + 4 testine goshsdlf-backrest + seat in painted planed beech plywood

code	finishing	q.kit	q.pack	a	b	c	d	e	f	kg.x1	vol.x1
124007-000	● faggio/beech-wood	x1	10	325	465	415	460	10	10	2,70	mc. 0,07

and · 07

90 swivel

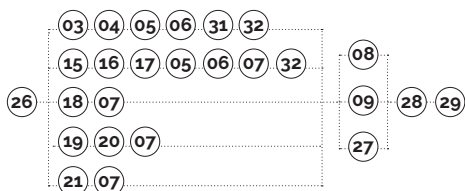

main component sizes

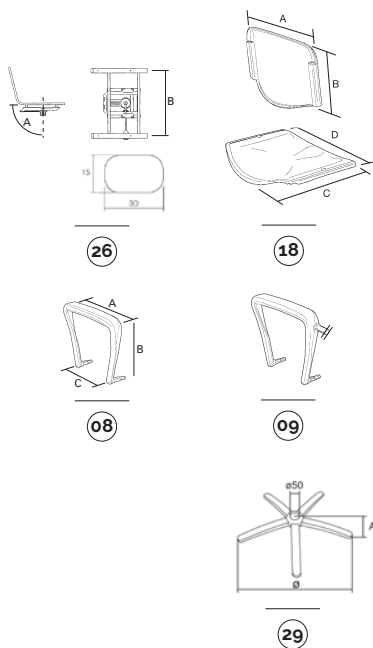

26 g2gv-telaio per sedia girevole in tubo ovale 30x15 con piastra comando a gas compresso di spatola, tappi esclusi
g2gv-swivel chair frame in 30x15 oval tube with gas control plate incl. spatula, excluding caps

code	finishing	arm attach	q.kit	q.pack	a	b	kg.x1	vol.x1
112003-200	● nero/black	14	x1	200	87"	425	2.62	mc. 0.015
112003-201	● nero/black	12	x1	200	87"	425	2.62	mc. 0.015
112010-200	● cromato/chrome	14	x1	200	87"	425	2.62	mc. 0.015
112010-201	● cromato/chrome	12	x1	200	87"	425	2.62	mc. 0.015

18 novx-sedile e schienale in plastica disponibili per telaio in tubo ovale e in tubo ellittico
novx-plastic seat and backrest available for oval or elliptic tube frame

code	finishing	q.kit	q.pack	a	b	c	d	kg.x1	vol.x1
134002-001	● rosso/red	ral3002	x1	20	470	315	460 400	1.21	mc. 0.008
134003-119	● nero/black	ral9005	x1	20	470	315	460 400	1.21	mc. 0.008
134015-003	● blu/blue	ral5002	x1	20	470	315	460 400	1.21	mc. 0.008

08 gob-bracciolo in nylon
gob-nylon armrest

code	finishing	arm attach	q.kit	q.pack	a	b	c	kg.x1	vol.x1
131703-002	● nero/black	14	x2	20	290	250	190	0.80	mc. 0.0026
131703-004	● nero/black	12	x2	20	290	250	190	0.80	mc. 0.0026

09 gobp-bracciolo in nylon con aggancio porta tavoletta
gobp-nylon armrest with writing tablet hook

code	finishing	arm attach	q.kit	q.pack	a	b	c	d	kg.x1	vol.x1
131703-001	● nero/black	14	x1	20	290	250	190	15x15	0.80	mc. 0.0026
131703-003	● nero/black	12	x1	20	290	250	190	15x15	0.80	mc. 0.0026

07 vite testa svasata croce m6x18 brunita nera-fissaggio sedile/ schienale faggio
m6x18 black burnished flared philips screw-beech seat/backrest fixing

code	finishing	q.kit
117703-195	● nero/black	x4

27 confezione tappi copritesta d.18 neri
black cover head caps d.18 package

code	finishing	diameter	q.kit	q.pack
137003-070	● nero/black	ø18	x4	200
134103-151	● nero/black	ø15	x4	

28 confezione tappi copritesta ovali 30x15 neri
black oval cover head caps 30x15 package

code	finishing	q.kit	q.pack
137003-071	● nero/black	x4	200

29 b40 base in metallo d.640 con coprisaldatura
b40 metal base d.640 with cover welding

code	finishing	q.kit	q.pack	a	ø	kg.x1	vol.x1
110210-027	● cromato/chrome	x1	5	60	640	2.85	mc. 0.014

90

swivel/backrest and seat options

main component sizes

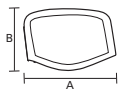

15

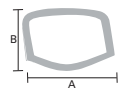

16

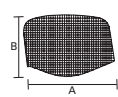

17



15 isonet-telaio schienale in plastica con viti per rete
isonet-outer frame with screws for net

code	finishing	q.kit	q.pack	a	b	kg.x1	vol.x1
132103-003	● nero/black	x1	25	470	345	0,42	mc. 0,006

16 isonet-cornice schienale in plastica per rete
isonet-open frame for isonet model

code	finishing	q.kit	q.pack	a	b	kg.x1	vol.x1
132103-004	● nero/black	x1	25	470	345	0,31	mc. 0,004

17 isonet-rette per schienale
isonet-net for back

code	finishing	q.kit	q.pack	a	b	kg.x1	vol.x1
132105-500	○ bianco/white	x1	25	550	400	0,14	mc. 0,0057
132103-500	● nero/black	x1	25	550	400	0,14	mc. 0,0057
132102-500	● rosso/red	x1	25	550	400	0,14	mc. 0,0057

and · (05) (06) (07) (32)

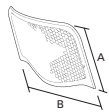

03

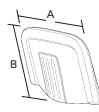

04



03 gosshi-schienale interno in plastica
gosshi-inner plastic back

code	finishing	q.kit	q.pack	a	b	kg.x1	vol.x1
132103-002	● nero/black	x1	40	330	470	0,60	mc. 0,004

04 goshe-coprischienale esterno in plastica
goshe-outer plastic back

code	finishing	q.kit	q.pack	a	b	kg.x1	vol.x1
132103-001	● nero/black	x1	30	475	335	0,40	mc. 0,004

and · (05) (06) (31) (32)

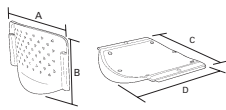

19

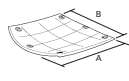

20



19 prisma-schienale e sedile in plastica disponibili per telaio in tubo ovale e in tubo ellittico
prisma-plastic backrest and seat available for oval or elliptic tube frame

code	finishing	q.kit	q.pack	a	b	c	d	kg.x1	vol.x1
134003-110	● nero/black	x1	10	470	330	460	430	1,60	mc. 0,016

20 prisma-pannello sedile da tappezzare
prisma-seat panel to upholster

code	finishing	q.kit	q.pack	a	b	kg.x1	vol.x1
132203-010	● nero/black	x1	20	400	400	0,40	mc. 0,004

and · (07)

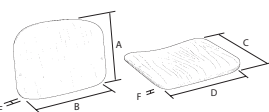

21



21 goshsdlf-schienale + sedile multistrato verniciato faggio + 4 testine
goshsdlf-backrest + seat in painted planed beech plywood

code	finishing	q.kit	q.pack	a	b	c	d	e	f	kg.x1	vol.x1
124007-000	● faggio/beech-wood	x1	10	325	465	415	460	10	10	2,70	mc. 0,07

and · (07)

90 bench



CERTIFIED BY
CATAS

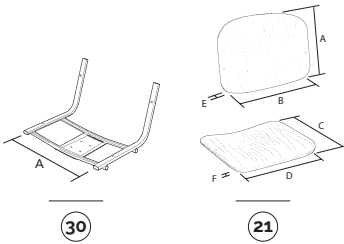
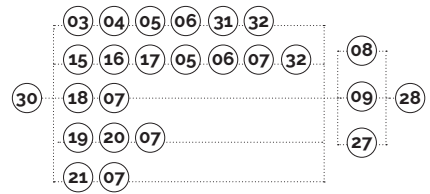

30 92pv-telaio in tubo ovale o ellittico per panca verniciata
92pv-oval or elliptic tube frame for painted bench

code	finishing	arm attach	q.kit	q.pack	a	kg.x1	vol.x1
110703-061	● nero/black	12 ovale/oval	x1	200	425	2,20	mc. 0.015
110703-062	● nero/black	14 ovale/oval	x1	200	425	2,20	mc. 0.015

21 90shsdlf-schienale + sedile multistrato verniciato faggio + 4 testine
90shsdlf-backrest + seat in painted planed beech plywood

code	finishing	q.kit	q.pack	a	b	c	d	e	f	kg.x1	vol.x1
124007-000	● faggio/beech-wood	x1	10	325	465	415	460	10	10	2,70	mc. 0.07

07 vite testa svasata croce m6x18 brunita nera-fissaggio sedile/ schienale faggio
m6x18 black burnished flared philips screw-beech seat/backrest fixing

code	finishing	q.kit
117703-195	● nero/black	x4

27 confezione tappi copritesta d.18 neri
black cover head caps d.18 package

code	finishing	diameter	q.kit	q.pack
137003-070	● nero/black	ø18	x4	200
134103-151	● nero/black	ø15	x4	

28 confezione tappi copritesta ovali 30x15 neri
black oval cover head caps 30x15 package

code	finishing	q.kit	q.pack
137003-071	● nero/black	x4	200

for the bench components, see page 201

OPTIONAL
bench
connector

E-USB **NEW**
bench plug



JIM **NEW**
bench leg

APOLL
bench arm



plastic

90GM
bench leg

90GF
bench leg

100GM
bench leg

200GM
bench leg

PIONEER
bench arm



metal

CUT
bench leg

SLIM
bench leg

CUT
bench arm

SLIM
bench arm



aluminium

