





**manila**

---



# manila



---

slide

4 legs

swivel

bench

manila showing



tools



brochure



**La monoscoocca in plastica con braccioli integrati.**

Una seduta ampia, confortevole e resistente, dal design sottile e distintivo, con braccioli disegnati per abbracciarla. Estremamente versatile grazie al ricco assortimento di telai, opzionabili anche in diverse finiture.

**Plus:**

- dimensioni generose e massimo comfort della scocca;
- design distintivo grazie ai braccioli integrati e alla scocca unica;
- 6 colori di tendenza disponibili per la scocca;
- massima versatilità;
- opzionabile il pannellino in legno da tappezzare.

**Manila** è nata per arredare qualsiasi **ambiente Community** e ben si adatta agli **ambienti Office**.

**Plastic monocoque chair with integrated armrests.**

*A generous, comfortable and durable seat, featuring a subtle-yet-distinctive design, with armrests designed to embrace. Extremely versatile thanks to the rich assortment of frames. Available in a range of finishes.*

**Advantages:**

- generously-dimensioned seat shell providing maximum comfort;
- distinctive design thanks to the integrated armrests and the unique seat shell;
- 6 trendy colours available for the seat shell;
- maximum versatility;
- optional wooden seat pad to be upholstered.

**Manila** was created to furnish any **Community environment** and adapts perfectly also to **Office environments**.

# manila

slide



plastic colours

- rosso/red p1797u
- grigio/grey warm grey 6c
- avorio/ivory ral1013
- marrone/brown ral69g
- giallo/yellow ral110u
- blu/blue ral5014

main component sizes

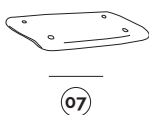
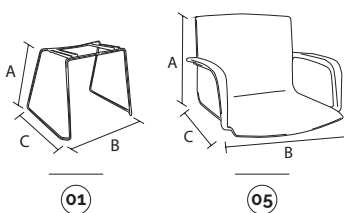

optipnats

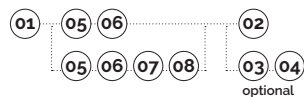
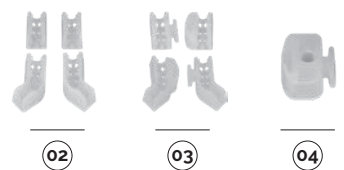

## 01 manila-telaio a slitta in tondino d.12 manila-slide wire framed.12

code	finishing	q.kit	q.pack	a	b	c	kg.x1	vol.x1
113403-333	● nero/black	x1	100	445	580	495	4,00	mc. 0,026
113405-333	○ avorio/ivory ral1013	x1	100	445	580	495	4,00	mc. 0,026
113410-333	● cromato/chrome	x1	100	445	580	495	4,00	mc. 0,026

## 02 btf-kit piedini btf-kit feet

code	finishing	q.kit	q.pack	kg.x1
134306-001	○ neutro/neutral	x1	100	0,05

## 03 btfa-kit piedini con ganci btfa-kit feet with hooks

code	finishing	q.kit	q.pack	kg.x1
134306-002	○ neutro/neutral	x1	100	0,06

## 04 pptf-tappo per fissaggio pavimento pptf-cap for fixing to the floor

code	finishing	q.kit	q.pack	kg.x1
134306-003	○ neutro/neutral	x2	100	0,03

## 05 manila-scocca intera con braccioli manila-plastic shell with arms

code	finishing	q.kit	q.pack	a	b	c	kg.x1	vol.x1
133904-045	● grigio/grey warm grey 6c	x1	5	390	580	480	2,60	mc. 0,05

## 06 manila-vite tc-combi 6x16 testa cilindrica a croce zincata (vite per fissaggio scocca) manila-screw combi 6x16 cylindrical head cross zinc (screw for fix shell)

code	finishing	q.kit
117811-181	● zincata/zinc	x4

## 07 manila-pannello sedile multistrato con 6 borchie m6 manila-seat panel with 6 upholstery nail m6

code	finishing	q.kit	q.pack	kg.x1	vol.x1
122207-034	● faggio/plywood	x1	20	0,78	mc. 0,003

## 08 manila-vite tbl combi m6x12 zincata bianca (vite per fissaggio pannello) manila-screw tbl combi m6x12 white zinc (screw for fix panel)

code	finishing	q.kit
117711-206	○ zincata bianca/white zinc	x6



for all colour codes, see page 181

# manila

slide



plastic colours

- rosso/red p1797u
- grigio/grey warm grey 6c
- avorio/ivory ral1013
- marrone/brown ral699
- giallo/yellow ral110u
- blu/blue ral5014

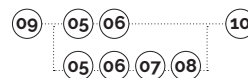

main component sizes

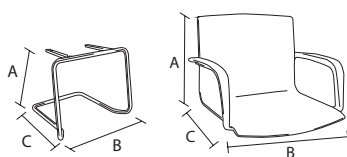

**09** manila-base a slitta in tubo asform d.22 tappi esclusi  
manila-slide frame asform pipe d.22 without caps

code	finishing	q.kit	q.pack	a	b	c	kg.x1	vol.x1
110503-417	● nero/black	x1	64	450	545	545	4,10	mc. 0.0313
110504-417	● grigio/grey ig2621	x1	64	450	545	545	4,10	mc. 0.0313
110505-417	○ avorio/ivory ral1013	x1	64	450	545	545	4,10	mc. 0.0313
110510-417	● cromato/chrome	x1	64	450	545	545	4,10	mc. 0.0313

**10** p2p-pinza due pioli in polietilene nera  
p2p-two pins pliers in black polythene

code	finishing	q.kit
134003-003	● nero/black	x6

**05** manila-scocca intera con braccioli  
manila-plastic shell with arms

code	finishing	q.kit	q.pack	a	b	c	kg.x1	vol.x1
133904-045	● grigio/grey warm grey 6c	x1	5	390	580	480	2,60	mc. 0.05

**06** manila-vite tc+combi 6x16 testa cilindrica a croce zincata (vite per fissaggio scocca)  
manila-screw combi 6x16 cylindrical head cross zinc (screw for fix shell)

code	finishing	q.kit
117811-181	● zincata/zinc	x4

**07** manila-pannello sedile multistrato con 6 borchie m6  
manila-seat panel with 6 upholstery nail m6

code	finishing	q.kit	q.pack	kg.x1	vol.x1
122207-034	● faggio/plywood	x1	20	0,78	mc. 0.003

**08** manila-vite tbl combi m6x12 zincata bianca (vite per fissaggio pannello)  
manila-screw tbl combi m6x12 white zinc (screw for fix panel)

code	finishing	q.kit
117711-206	○ zincata bianca/white zinc	x6



for all colour codes, see page 181



# manila

4-legs

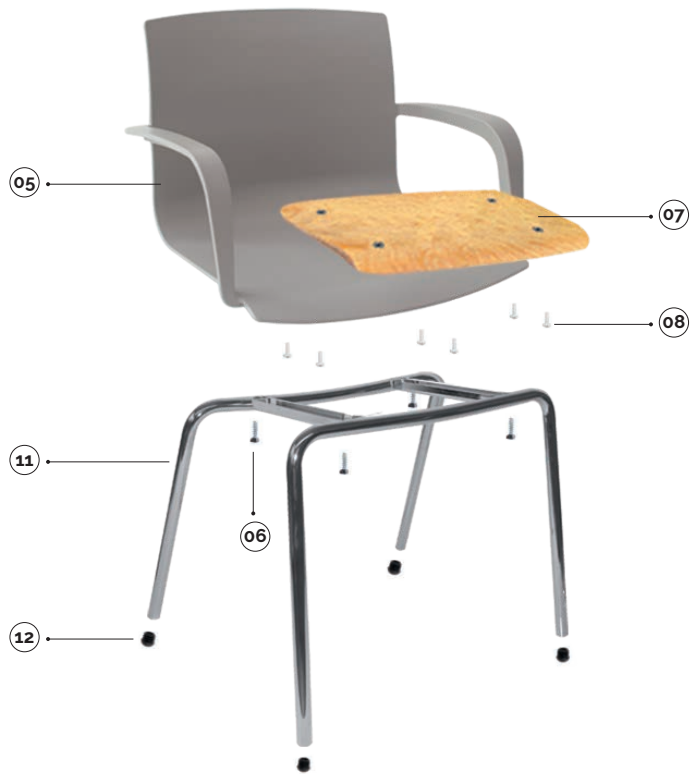

plastic colours

- rosso/red p1797u
- grigio/grey warm grey 6c
- avorio/ivory ral1013
- marrone/brown ral69g
- giallo/yellow ral110u
- blu/blue ral5014

main component sizes

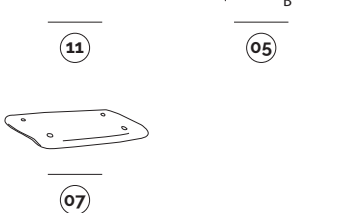
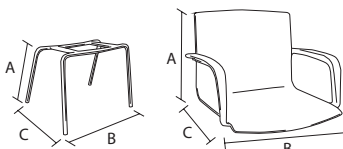

## 11 manila-telaio 4 gambe d.22 senza tappi

manila-4 legs frames d.22 without caps

code	finishing	q.kit	q.pack	a	b	c	kg.x1	vol.x1
110103-259	● nero/black	x1	80	440	585	490	2,70	mc. 0.035
110104-259	● grigio/grey ig2621	x1	80	440	585	490	2,70	mc. 0.035
110105-259	○ avorio/ivory ral1013	x1	80	440	585	490	2,70	mc. 0.035
110110-259	● cromato/chrome	x1	80	440	585	490	2,70	mc. 0.035

## 12 tappo 22 testa sferica nero

cap 22 spherical head black

code	finishing	q.kit
134203-224	● nero/black	x4

## 05 manila-scocca intera con braccioli

manila-plastic shell with arms

code	finishing	q.kit	q.pack	a	b	c	kg.x1	vol.x1
133904-045	● grigio/grey warm grey 6c	x1	5	390	580	480	2,60	mc. 0.05

## 06 manila-vite tc•combi 6x16 testa cilindrica a croce zincata (vite per fissaggio scocca)

manila-screw combi 6x16 cylindrical head cross zinc (screw for fix shell)

code	finishing	q.kit
117811-181	● zincata/zinc	x4

## 07 manila-pannello sedile multistrato con 6 borchie m6

manila-seat panel with 6 upholstery nail m6

code	finishing	q.kit	q.pack	kg.x1	vol.x1
122207-034	● faggio/plywood	x1	20	0,78	mc. 0.003

## 08 manila-vite tbi combi m6x12 zincata bianca (vite per fissaggio pannello)

manila-screw tbi combi m6x12 white zinc (screw for fix panel)

code	finishing	q.kit
117711-206	○ zincata bianca/white zinc	x6



for all colour codes, see page 181

# manila

swivel



plastic colours

- rosso/red p1797u
- grigio/grey warm grey 6c
- avorio/ivory ral1013
- marrone/brown ral699
- giallo/yellow ral110u
- blu/blue ral5014

main component sizes

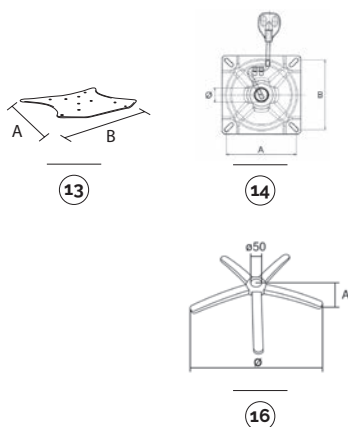

optional

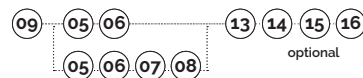
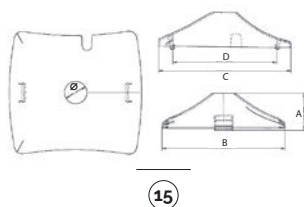

## 13 manila-telaio per girevole/panca manila-swivel/bench frame

code	finishing	q.kit	q.pack	a	b	kg.x1	vol.x1
110903-256	● nero/black	x1	10	265	325	2,00	mc. 0.0019
110904-256	● grigio/grey ig2621	x1	10	265	325	2,00	mc. 0.0019

## 14 pss28nr-piastra sgabello c/spat. c/28 3' l4 nera pss28nr- square metal plate with straight lever c/28 3' l4

code	finishing	q.kit	q.pack	a	b	ø	kg.x1	vol.x1
113003-104	● nero/black	x1	25	150	150	28	1,23	mc. 0.002

## 15 cpg-copertina in plastica per telaio girevole cpg-plastic cover for swivel frame

code	finishing	q.kit	q.pack	a	b	c	d	ø	kg.x1	vol.x1
130903-000	● nero/black	x1	50	60	200	210	167	36	0,1	mc. 0.0015

## 16 b40-base in metallo d.640 con coprisaldatura b40-metal base d.640 with cover welding

code	finishing	q.kit	q.pack	a	ø	kg.x1	vol.x1
110210-027	● cromato/chrome	x1	5	60	640	2,85	mc. 0.014

for the components below, see page 178

05 06 07 08

CPG  
plastic cover for swivel frame



for all colour codes, see page 181



# manila

bench



plastic colours

- rosso/red p1797u
- grigio/grey warm grey 6c
- avorio/ivory ral1013
- marrone/brown ral699
- giallo/yellow ral110u
- blu/blue ral5014



main component sizes

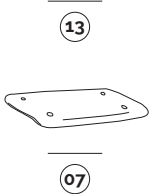
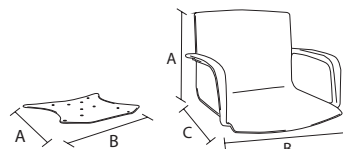

## 13 manila-telaio per girevole/panca manila-swivel/bench frame

code	finishing	q.kit	q.pack	a	b	kg.x1	vol.x1
110903-256	● nero/black	x1	10	265	325	2,00	mc. 0,0019
110904-256	● grigio/grey ig2621	x1	10	265	325	2,00	mc. 0,0019

## 05 manila-scocca intera con braccioli manila-plastic shell with arms

code	finishing	q.kit	q.pack	a	b	c	kg.x1	vol.x1
133904-045	● grigio/grey warm grey 6c	x1	5	390	580	480	2,60	mc. 0,05

## 06 manila-vite tc-combi 6x16 testa cilindrica a croce zincata (vite per fissaggio scocca) manila-screw combi 6x16 cylindrical head cross zinc (screw for fix shell)

code	finishing	q.kit
117811-181	● zincata/zinc	x4

## 07 manila-pannello sedile multistrato con 6 borchie m6 manila-seat panel with 6 upholstery nail m6

code	finishing	q.kit	q.pack	kg.x1	vol.x1
122207-034	● faggio/plywood	x1	20	0,78	mc. 0,003

## 08 manila-vite tbi combi m6x12 zincata bianca (vite per fissaggio pannello) manila-screw tbi combi m6x12 white zinc (screw for fix panel)

code	finishing	q.kit
117711-206	○ zincata bianca/white zinc	x6

for the bench components, see page 249



for all colour codes, see page 181

optionals

OPTIONAL  
bench connector



E-USB **NEW**  
bench plug

JIM **NEW**  
bench leg



plastic

APOLL  
bench arm

90GM  
bench leg

90GF  
bench leg

100GM  
bench leg

200GM  
bench leg

PIONEER  
bench arm



metal

CUT  
bench leg

SLIM  
bench leg

CUT  
bench arm

SLIM  
bench arm



aluminium

# manila

optional colour codes



## shell colour codes



05 scocche in plastica  
plastic shells

- 133902-045 rosso/red p1797u
- 133904-045 grigio/grey warm grey 6c
- 133905-045 avorio/ivory ral1013
- 133907-045 marrone/brown ral699
- 133908-045 giallo/yellow ral110u
- 133915-045 blu/blue ral5014

