

alba components

_Maui collection

MAUI COLLECTION

Design: StudioPANG



Maui Dining



Maui Lounge



Maui Lounge Plus



Maui è una completa e versatile collezione di sedute imbottite da tappezzare, adatte a spazi contract, ambienti residenziali e ricettivi. Le poltroncine Maui sono disponibili in tre diverse tipologie di scocche in poliuretano: dining, lounge, lounge plus, tutte abbinabili a basi girevoli in alluminio o a slitta in tondino metallico.

Maui is a complete and versatile soft seating collection to be upholstered, suitable for contract spaces, residential settings, and receptive environments. Maui armchairs are available in three different types of polyurethane shells: dining, lounge, lounge plus, all of which can be combined with aluminium swivel or metal rod sled bases.



MAUI **DINING**

Nella versione Dining, Maui è una versatile poltroncina adatta a zone restaurant e living, ma ideale anche ad arredare una camera d'hotel. Disponibile con telaio a slitta nei colori bianco, nero, cromo, o con base girevole in alluminio nelle finiture nera o lucida.

In the Dining version, Maui is featured as a versatile armchair suitable for restaurant and living areas, but also ideal for furnishing hotel rooms. Available with sled frame in white, black, chrome, or aluminium swivel base in black or polished finishes.







MAUI LOUNGE

Nella versione Lounge, le linee avvolgenti della poltrona Maui vengono ancor più valorizzate, amplificando il comfort della seduta che diventa ideale per eleganti aree lounge e ambienti d'attesa. Disponibile con telaio a slitta nei colori bianco, nero, cromo, o con base girevole in alluminio lucido o nero.

In the Lounge version, the enveloping lines of the Maui armchair are further enhanced, amplifying the comfort of the seat which becomes ideal for elegant lounge areas and waiting environments. Available with sled frame in white, black, chrome, or swivel base in polished aluminium or black.







MAUI LOUNGE PLUS

La versione Lounge Plus è una comoda e avvolgente poltrona caratterizzata da un alto schienale che si integra armoniosamente con le linee dei braccioli, tipici della collezione Maui. La poltrona è adatta sia agli spazi pubblici che ai contesti domestici, dove mantenere l'intimità e il comfort sono essenziali.

The Lounge Plus version is a comfortable, enveloping armchair characterized by a high backrest that harmoniously blends with the lines of the armrests, typical of the Maui collection. The armchair is suitable for both spaces in public settings and private homes, where maintaining intimacy and comfort are essential.





Quote geometriche / *Geometric dimensions*

Maui Dining

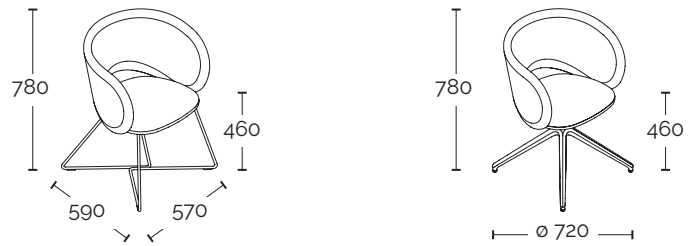

Maui Lounge

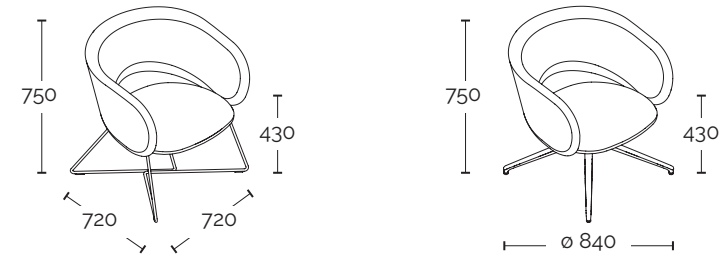

Maui Lounge Plus

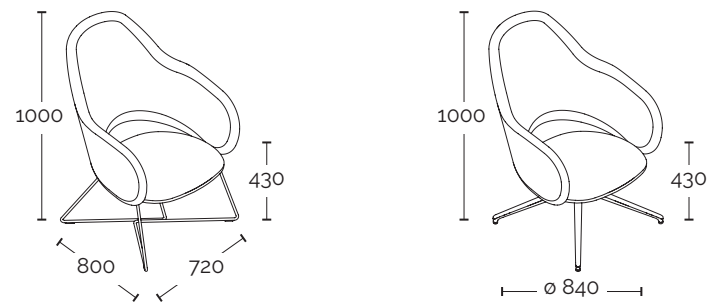

Finiture / *Finishes*

Telai a slitta / *Sled frames*



Bianco
White

Nero
Black

Cromo
Chrome

CUSTOM
RAL

Q.tà Min.
Min. Q.ty

Basi girevoli in alluminio / *Aluminium swivel bases*



Nero
Black

Lucido
Polished

Note / *Notes*

Le scocche delle sedute sono fornite grezze, da tappezzare.
Seat shells are supplied unfinished, to be upholstered.

Kit prodotto / Product kit

Maui Dining slitta / sled

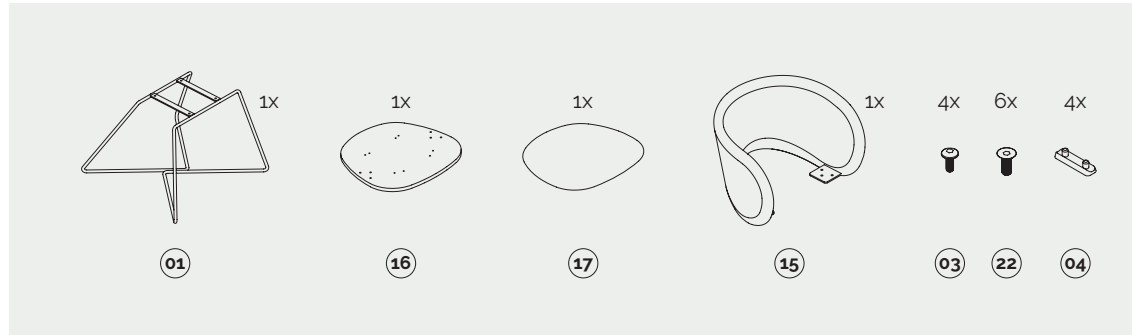
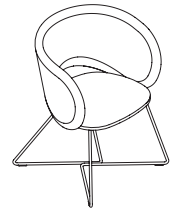

Maui Lounge girevole / swivel

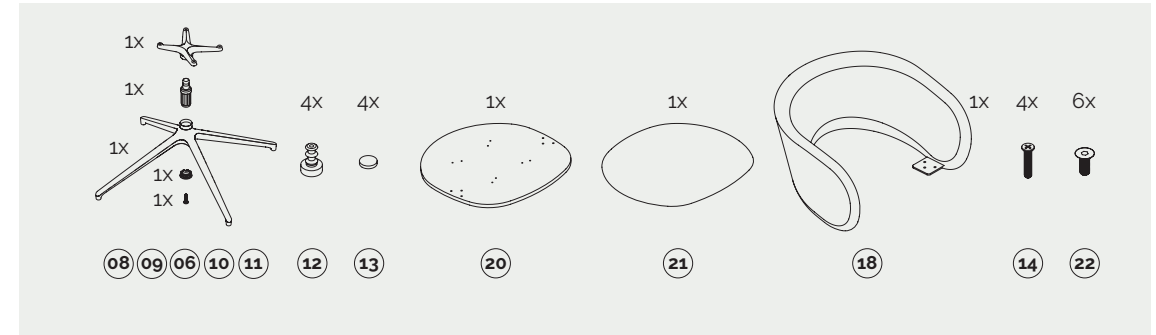
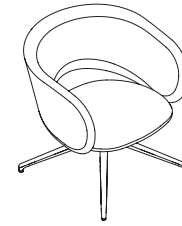

Maui Dining girevole / swivel

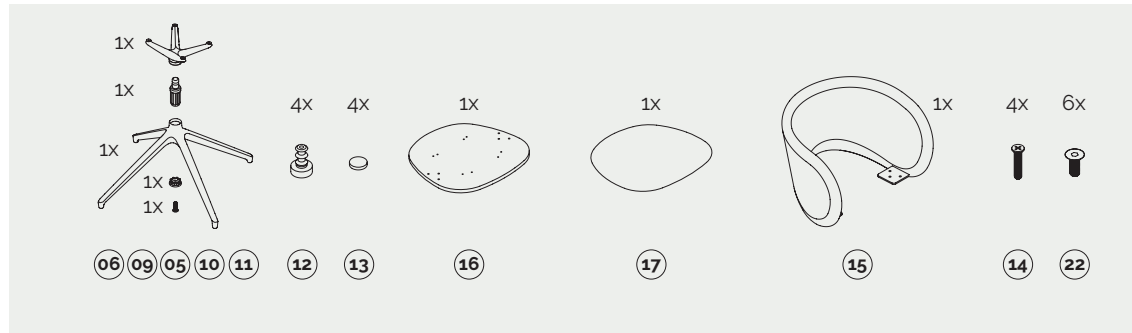

Maui Lounge plus slitta / sled

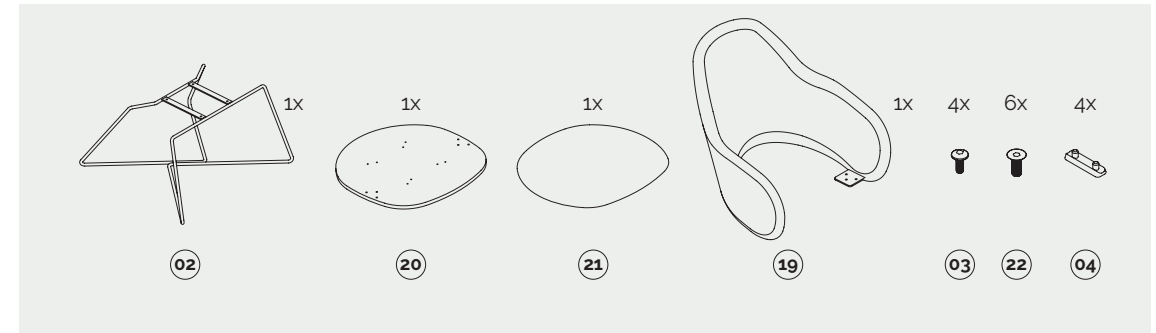

Maui Lounge slitta / sled

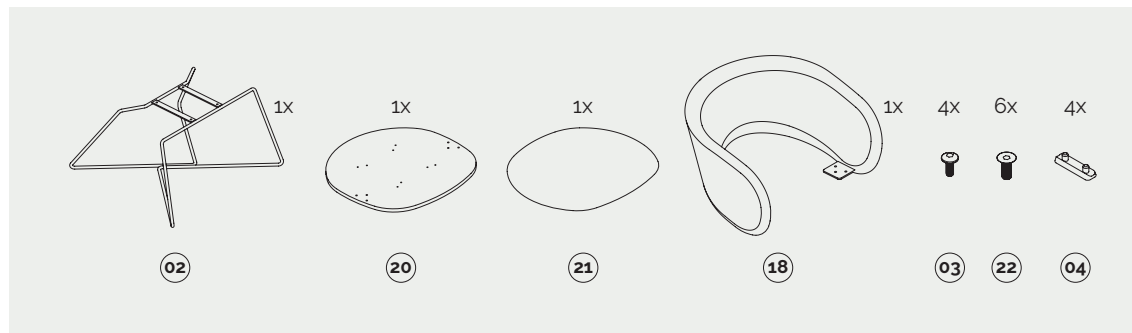
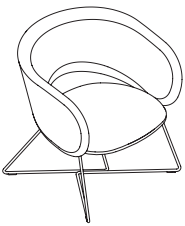

Maui Lounge plus girevole / swivel

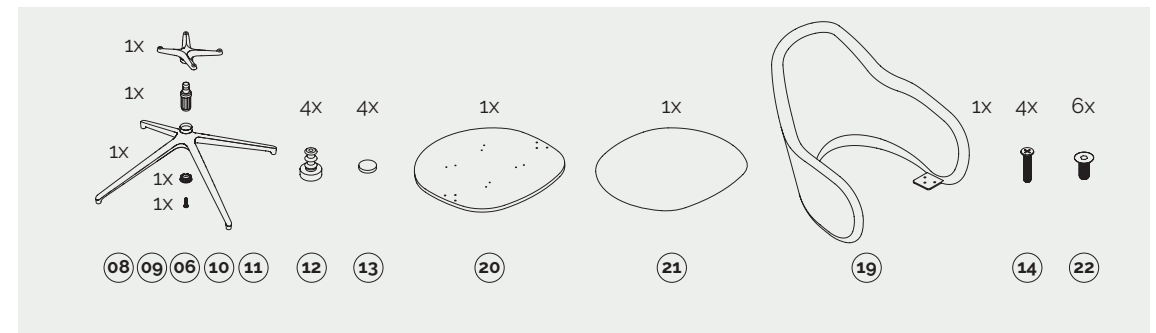

Codici componenti / Components codes

Telai / Frames

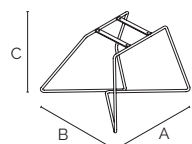

01 Maui Dining | Telaio a slitta Ø12
Maui Dining | Sled frame Ø12

code	finishing	q.kit	q.pack	a	b	c	kg.x1	vol.x1
A113403-115	● Nero / Black	x1	/	560	540	410	3,95	/
A113405-115	● Bianco / White	x1	/	560	540	410	3,95	/
113410-115	● Cromo / Chrome	x1	/	560	540	410	3,95	/

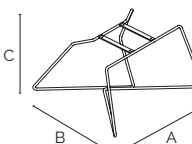

02 Maui Lounge - Lounge Plus | Telaio a slitta - Ø12
Maui Lounge - Lounge Plus | Sled frame Ø12

code	finishing	q.kit	q.pack	a	b	c	kg.x1	vol.x1
A113403-110	● Nero / Black	x1	/	650	610	360	4,30	/
A113405-110	● Bianco / White	x1	/	650	610	360	4,30	/
113410-110	● Cromo / Chrome	x1	/	650	610	360	4,30	/



03 Telaio a slitta | Vite dentellata TBEI M6x16
Sled frames | TBEI M6x16 knurled screw

code	finishing	q.kit	q.pack
117711-185	● Bianco zincato / Zinc-plated white	x4	/



04 Telaio a slitta | Piedino in plastica a due pioli
Sled frames | Two pins plastic glide

code	finishing	q.kit	q.pack
A134303-000	● Nero / Black	x4	/

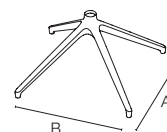

05 Maui Dining | Base Kylie in alluminio a 4 razze - Ø720
Maui Dining | Kylie 4-spokes aluminium base - Ø720

code	finishing	q.kit	q.pack	a	b	kg.x1	vol.x1
A110203-100	● Nero / Black	x1	6	515	515	2,79	/
A110210-000	● Lucido / Polished	x1	6	515	515	2,79	/

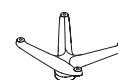

06 Maui Dining | Supporto in alluminio per base Kylie - Ø720
Maui Dining | Aluminium support for Kylie base - Ø720

code	finishing	q.kit	q.pack	kg.x1	vol.x1
A110203-103	● Nero / Black	x1	6	0,71	/
A110210-003	● Lucido / Polished	x1	6	0,71	/

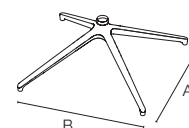

07 Maui Lounge - Lounge Plus | Base Kylie in alluminio a 4 razze - Ø840
Maui Lounge - Lounge Plus | Kylie 4-spokes aluminium base - Ø840

code	finishing	q.kit	q.pack	a	b	kg.x1	vol.x1
A110203-101	● Nero / Black	x1	6	600	600	3,33	/
A110210-016	● Lucido / Polished	x1	6	600	600	3,33	/

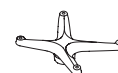

08 Maui Lounge - Lounge Plus | Supporto in alluminio per base Kylie - Ø840
Maui Lounge - Lounge Plus | Aluminium support for Kylie base - Ø840

code	finishing	q.kit	q.pack	kg.x1	vol.x1
A110203-104	● Nero / Black	x1	6	0,65	/
A110210-008	● Lucido / Polished	x1	6	0,65	/

Codici componenti / Components codes

Telai / Frames



09 Basi in alluminio a 4 razze Kylie | Adattatore in metallo
Kylie 4-spoke aluminium bases | Metal adapter

code	finishing	q.kit	q.pack	kg.x1
A110210-001	● Zincato / Zinc-plated	x1	6	/



13 Basi in alluminio a 4 razze Kylie | Feltro per piedino in polipropilene
Kylie 4-spoke aluminium bases | Polypropylene glide felt

code	finishing	q.kit	q.pack
A110210-005	● Nero / Black	x4	24



10 Basi in alluminio a 4 razze Kylie | Tappo sottobase
Kylie 4-spoke aluminium bases | Under-base cap

code	finishing	q.kit	q.pack	kg.x1
A110210-002	● Grigio / Grey	x1	6	/



14 Basi in alluminio a 4 razze Kylie | Vite TSP+ M6x30
Kylie 4-spoke aluminium bases | TSP+ M6x30 screw

code	finishing	q.kit	q.pack
117711-192	● Bianco zincato / Zinc-plated white	x4	/



11 Basi in alluminio a 4 razze Kylie | Vite TSP+ M6x20
Kylie 4-spoke aluminium bases | TSP+ M6x20 screw

code	finishing	q.kit	q.pack
117711-203	● Bianco zincato / Zinc-plated white	x1	6



12 Basi in alluminio a 4 razze Kylie | Piedino in polipropilene
Kylie 4-spoke aluminium bases | Polypropylene glide

code	finishing	q.kit	q.pack	kg.x1
A110210-004	● Grigio / Grey	x4	24	/

Scocche / Shells

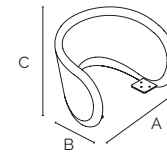

15 Maui Dining | Scocca schienale
Maui Dining | Backrest shell

code	finishing	q.kit	q.pack	a	b	c	kg.x1	vol.x1
A133908-008	∅ Da tappezzare / To be upholstered	x1	/	590	490	400	8.00	/

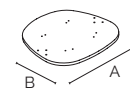

16 Maui Dining | Pannello in multistrato per sedile
Maui Dining | Plywood seat panel

code	finishing	q.kit	q.pack	a	b	kg.x1	vol.x1
A123607-069	● Pino / Pinewood	x1	/	470	450	1.60	/

Codici componenti / Components codes

Scocche / Shells



17 Maui Dining | Cuscino per sedile
Maui Dining | Seat cushion

code	finishing	q.kit	q.pack	a	b	kg.x1	vol.x1
A134001-006	∅ Da tappezzare / To be upholstered	x1	/	470	450	0,332	/

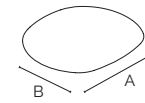

21 Maui Lounge - Lounge Plus | Cuscino per sedile
Maui Lounge - Lounge Plus | Seat cushion

code	finishing	q.kit	q.pack	a	b	kg.x1	vol.x1
A134001-005	∅ Da tappezzare / To be upholstered	x1	/	580	580	0,57	/

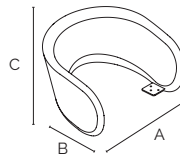

18 Maui Lounge | Scocca schienale
Maui Lounge | Backrest shell

code	finishing	q.kit	q.pack	a	b	c	kg.x1	vol.x1
A133908-010	∅ Da tappezzare / To be upholstered	x1	/	720	670	410	10,80	/



22 Maui Dining - Lounge - Lounge Plus | Vite con frenafletti TSPEI M8x20
Maui Dining - Lounge - Lounge Plus | TSPEI M8x20 screw with threadlocking

code	finishing	q.kit	q.pack
117703-257	● Nero brunito / Burnished black	x6	/

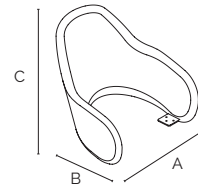

19 Maui Lounge Plus | Scocca schienale
Maui Lounge Plus | Backrest shell

code	finishing	q.kit	q.pack	a	b	c	kg.x1	vol.x1
A133908-009	∅ Da tappezzare / To be upholstered	x1	/	720	755	670	11,30	/

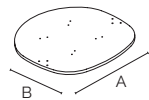

20 Maui Lounge - Lounge Plus | Pannello in multistrato per sedile
Maui Lounge - Lounge Plus | Plywood seat panel

code	finishing	q.kit	q.pack	a	b	kg.x1	vol.x1
A123607-070	● Pino / Pinewood	x1	/	580	580	2,78	/

Edition
02/2024

albacomponents

albacomponents.it | info@albacomponents.it | +39 0423 969700
Metalmeccanica Alba Srl | Via Boschier, 54/A - 31020 San Zenone degli Ezzelini (Italy)