



BEYOND | **Solutions**





**X3**



# X3



---

slide  
slide w/armrests  
slide w/writing tablet

4 legs  
4 legs w/armrest  
4 legs w/writing tablet

swivel  
swivel w/armrest

bench  
bench w/armrest

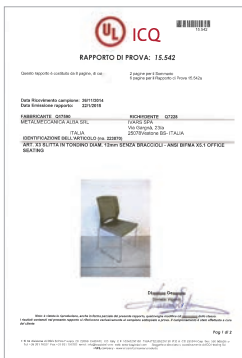

BIFMA TEST



BIFMA TEST

x3 showing



tools



certification



Una **seduta in plastica** disponibile in 4 colori, caratterizzata da un **design distintivo**.

Prevede diverse versioni: schienale in plastica pieno o traforato, schienale in rete, pannelli sedile e schienale in plastica da tappezzare.

È inoltre possibile scegliere tra un ampio assortimento di telai, offrendo così soluzioni differenti per ambienti **Office e Community**, grazie anche alla pratica impilabilità. **X3** è una seduta **certificata CATAS e BIFMA**.

*Plastic chair available in 4 colours, characterized by a **distinctive design**.*

*Available in a range of different versions: solid or perforated plastic back, mesh back, or seat and back panels in plastic to be upholstered.*

*With a wide selection of frames to choose from it offers a full range of solutions for **Office and Community** environments, and its stackability means it's also highly practical. **X3 is CATAS and BIFMA certified**.*

# X3 slide

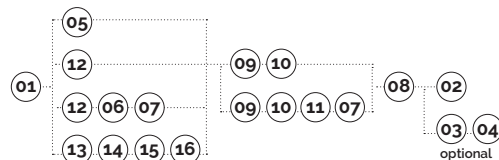
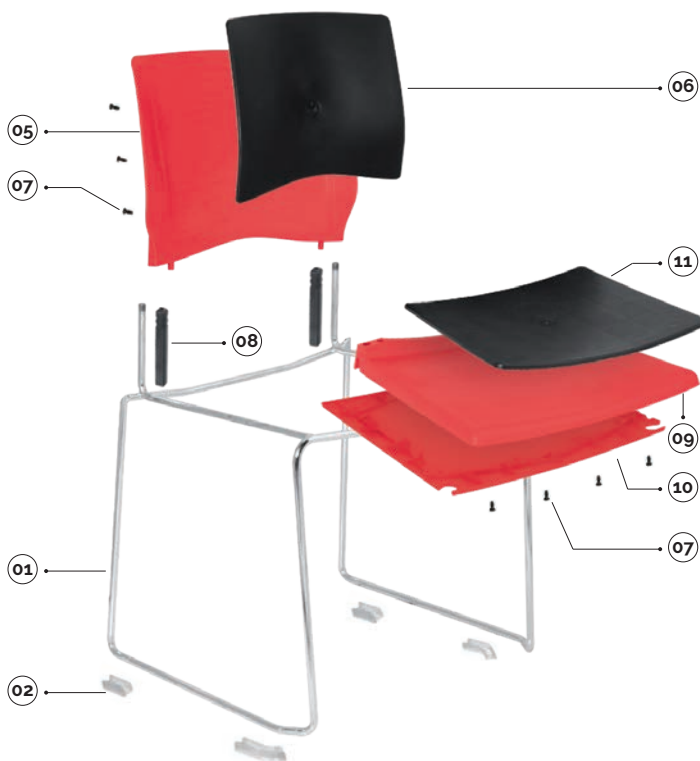

plastic colours

- grigio/gray ral 7003
- nero/black
- rosso/red 527
- bianco/white ral 1013

**x3-carrello portasedie con accessori**  
x3-trolley for chairs with accessories

code	finishing	q.kit	kg.x1
110803-346	● nero/black	x1	10,50

main component sizes

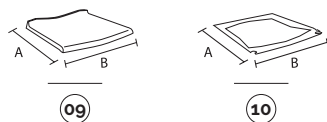
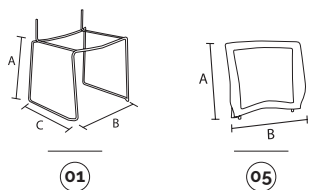

optional

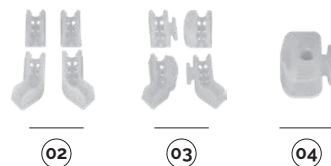

**01 x3-telaio a slitta in tondino d.12**  
x3-slide wire frame d.12

code	finishing	q.kit	q.pack	a	b	c	kg.x1	vol.x1
113410-062	● cromato/chrome	x1	60	450	530	505	4,20	mc. 0.03

**02 btf-kit piedini**  
btf-kit feet

code	finishing	q.kit	q.pack	kg.x1
134306-001	○ neutro/neutral	x1	100	0,05

**03 btf-kit piedini con ganci**  
btf-kit feet with hooks

code	finishing	q.kit	q.pack	kg.x1
134306-002	○ neutro/neutral	x1	100	0,06

**04 pptf-tappo per fissaggio pavimento**  
pptf-cap for fixing to the floor

code	finishing	q.kit	q.pack	kg.x1
134306-003	○ neutro/neutral	x2	100	0,03

**05 x3-schienale colorato a vista in plastica pieno**  
x3-colored full plastic back

code	finishing	q.kit	q.pack	a	b	kg.x1	vol.x1
132102-090	● rosso/red	x1	10	400	460	0,90	mc. 0.008

**08 x3-riduttore per schienale in plastica**  
x3-plastic adapter for the back

code	finishing	q.kit	q.pack	kg.x1	vol.x1
132103-009	● nero/black	x2	200	0,019	mc. 0.0001

**09 x3-sedile colorato a vista in plastica per telaio slitta**  
x3-colored plastic seat for wire frame

code	finishing	q.kit	q.pack	a	b	kg.x1	vol.x1
132202-019	● rosso/red	x1	10	450	460	1,20	mc. 0.015

**10 x3-sottosedile colorato a vista in plastica**  
x3-outer colored plastic seat

code	finishing	q.kit	q.pack	a	b	kg.x1	vol.x1
132202-009	● rosso/red	x1	20	450	460	0,73	mc. 0.007



for all colour codes, see page 93

# X3

## slide/backrest and seat options

main component sizes

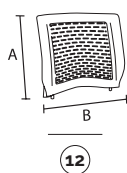

12



CERTIFIED BY  
**BIFMA**

- 12 x3-schienale colorato a vista in plastica forato  
x3-colored plastic back with holes

code	finishing	q.kit	q.pack	a	b	kg.x1	vol.x1
132102-019	● rosso/red 527	x1	10	400	460	0,90	mc. 0.008

and · 09 10

main component sizes

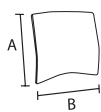

06



- 06 x3-pannello schienale da tappezzare in plastica  
x3-back panel for upholstery

code	finishing	q.kit	q.pack	a	b	kg.x1	vol.x1
132103-008	● nero/black	x1	20	350	385	0,50	mc. 0.003

- 11 x3-pannello sedile da tappezzare in plastica  
x3-seat panel for upholstery

code	finishing	q.kit	q.pack	a	b	kg.x1	vol.x1
132203-003	● nero/black	x1	20	400	410	0,60	mc. 0.003

- 07 vite hilo tb\* 5x12 cementata brunita nera  
screw tb+fr.hilo 5x12 black burnished

code	finishing	q.kit seat	q.kit back
117803-154	● nero/black	x8	x6

and · 12 09 10

main component sizes

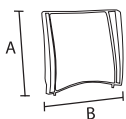

13



- 13 x3-schienale per rete nero a vista in plastica  
x3-black plastic for mesh back

code	finishing	q.kit	q.pack	a	b	kg.x1	vol.x1
132103-014	● nero/black	x1	10	400	460	0,60	mc. 0.008

- 14 x3-liste a\*b per schienale rete nere a vista  
x3-black plastic strips a\*b for mesh back

code	finishing	q.kit	q.pack	kg.x1	vol.x1
132103-013	● nero/black	x1	100	0,21	mc. 0.0004

- 15 x3-rete per schienale  
x3-net for back

code	finishing	q.kit	q.pack	a	b	kg.x1	vol.x1
132103-029	● nero/black	x1	50	400	460	0,14	mc. 0.0057

- 16 vite truciolare tsp\* d.3,5x10 brunita nera(per fissare schienale rete)  
shaving screw tsp\* d.3,5x10 zinc.(to fix mesh back)

code	finishing	q.kit
117803-105	● nero/black	x8

and · 09 10 11 07



# X3

slide w/writing tablet

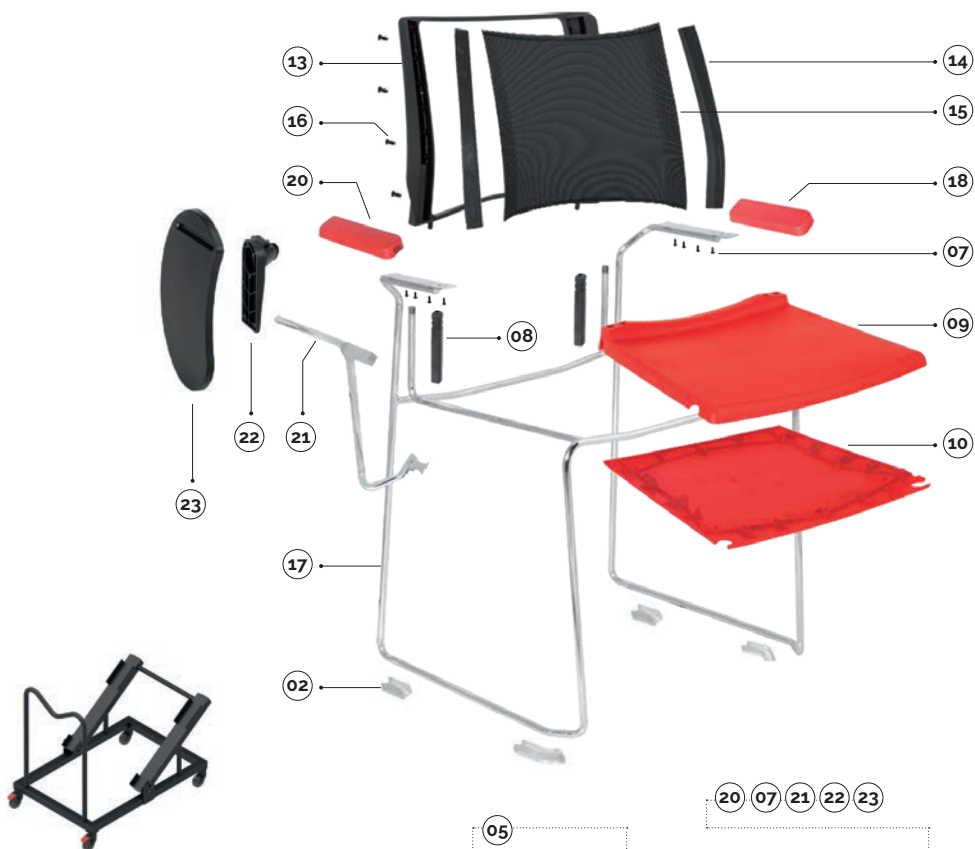

plastic colours

- grigio/gray ral 7003
- nero/black
- rosso/red 527
- bianco/white ral 1013

x3-carrello portasedie con accessori  
x3-trolley for chairs with accessories

code	finishing	q.kit	kg.x1
110803-346	● nero/black	x1	10,50

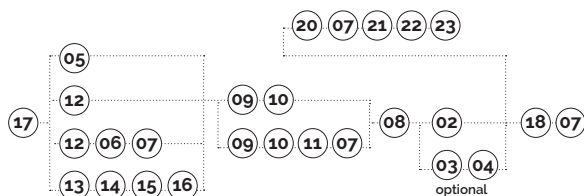

main component sizes

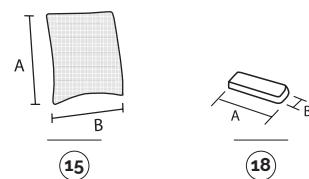
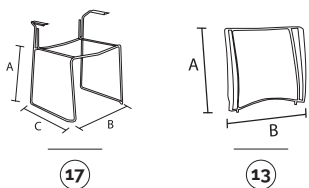

optipnats

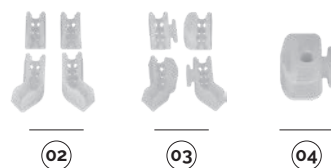

**17** x3-telaio a slitta in tondino d.12 con braccioli  
x3-slide wire frame d.12 with arms

code	finishing	q.kit	q.pack	a	b	c	kg.x1	vol.x1
113410-061	● cromato/chrome	x1	60	450	530	505	5,00	mc. 0.0035

**13** x3-schienale per rete nero a vista in plastica  
x3-black plastic for mesh back

code	finishing	q.kit	q.pack	a	b	kg.x1	vol.x1
132103-014	● nero/black	x1	10	400	460	0,60	mc. 0.008

**14** x3-liste a\*b per schienale rete nere a vista  
x3-black plastic strips a\*b for mesh back

code	finishing	q.kit	q.pack	kg.x1	vol.x1
132103-013	● nero/black	x1	100	0,21	mc. 0.0004

**15** x3-rete per schienale  
x3-net for back

code	finishing	q.kit	q.pack	a	b	kg.x1	vol.x1
132103-029	● nero/black	x1	50	400	460	0,14	mc. 0.0057

**16** vite truciolare tsp+ d.3,5x10 brunita nera(per fissare schienale rete)  
shaving screw tsp+ d.3,5x10 zinc.(to fix mesh back)

code	finishing	q.kit
117803-105	● nero/black	x8

**18** x3-bracciolo plastica colorato per telaio filo  
x3-colored plastic arm for wire frame

code	finishing	q.kit	q.pack	a	b	kg.x1	vol.x1	
131702-019	● rosso/red	527	x2	40	175	55	0,10	mc. 0.0004

**07** vite hilo tb+ 5x12 cementata brunita nera  
screw tb+fr.hilo 5x12 black burnished

code	finishing	q.kit seat	q.kit back
117803-154	● nero/black	x8	x6

for the components below, see page 78

02 03 04 08 09 10



for all colour codes, see page 93

# X3

## slide/tablet accessories

main component sizes

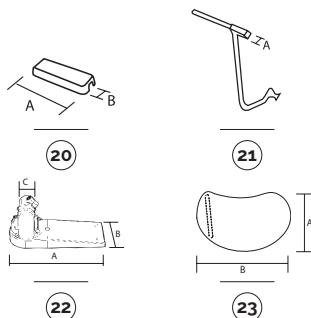

### 20 x3-bracciolo plastica colorato per telaio filo con tavoletta

x3-colored plastic arm for wire frame with tablet

code	finishing		q.kit	q.pack	a	b	kg.x1	vol.x1
131702-018	● rosso/red	527	x2	40	175	55	0,10	mc. 0,0004

### 21 x3-supperto tavoletta per slitta + viti

x3-tablet support for slide wire frame d.12 + screws

code	finishing		q.kit	q.pack		kg.x1	vol.x1
111703-044	● nero/black	destra/right - slitta/slide	x1	10	15x15	0,60	mc. 0,002
111703-047	● nero/black	sinistro/left - slitta/slide	x1	10	15x15	0,60	mc. 0,002
111710-044	● cromato/chrome	destra/right - slitta/slide	x1	10	15x15	0,60	mc. 0,002
111710-047	● cromato/chrome	sinistro/left - slitta/slide	x1	10	15x15	0,60	mc. 0,002

### 22 spt2-snodo per tavoletta in plastica

spt2-mechanism for writing tablet in plastic

code	finishing		q.kit	q.pack	a	b	c	kg.x1	vol.x1
134003-039	● nero/black		x1	20	180	66	15x15	0,35	mc. 0,0006

### 23 bean-tavoletta in plastica spessore 16

bean-writing tablet in plastic thickness 16 mm

code	finishing		q.kit	q.pack	a	b	kg.x1	vol.x1
134003-044	● nero/black		x1	20	235	370	0,40	mc. 0,002



for writing tablet options, see page 192/193

## slide w/armrests/backrest and seat options

main component sizes

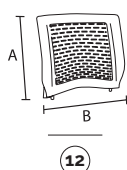

### 12 x3-schienale colorato a vista in plastica forato

x3-colored plastic back with holes

code	finishing		q.kit	q.pack	a	b	kg.x1	vol.x1
132102-019	● rosso/red	527	x1	10	400	460	0,90	mc. 0,008

and · 09 10

main component sizes

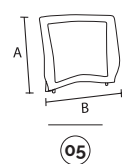

### 05 x3-schienale colorato a vista in plastica pieno

x3-colored full plastic back

code	finishing		q.kit	q.pack	a	b	kg.x1	vol.x1
132102-090	● rosso/red	527	x1	10	400	460	0,90	mc. 0,008

and · 09 10

main component sizes

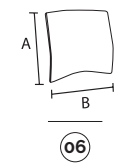

### 06 x3-pannello schienale da tappezzare in plastica

x3-back panel for upholstery

code	finishing		q.kit	q.pack	a	b	kg.x1	vol.x1
132103-008	● nero/black		x1	20	350	385	0,50	mc. 0,003

### 11 x3-pannello sedile da tappezzare in plastica

x3-seat panel for upholstery

code	finishing		q.kit	q.pack	a	b	kg.x1	vol.x1
132203-003	● nero/black		x1	20	400	410	0,60	mc. 0,003

### 07 vite hilo tb\* 5x12 cementata brunita nera

screw tb+fr.hilo 5x12 black burnished

code	finishing	q.kit seat	q.kit back
117803-154	● nero/black	x8	x6

and · 12 09 10



# X3

## 4-legs

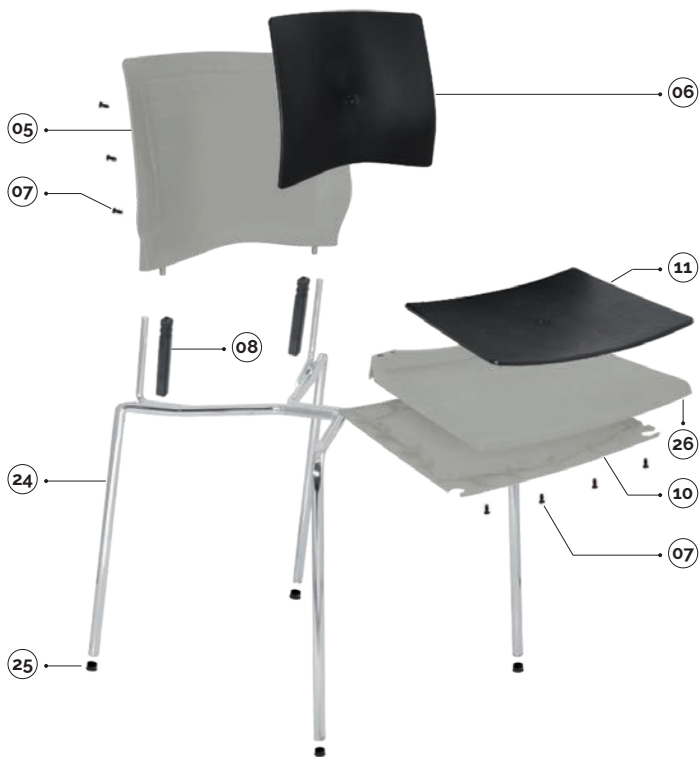

plastic colours

- grigio/gray ral 7003
- nero/black
- rosso/red 527
- bianco/white ral 1013

x3-carrello portasedie con accessori  
x3-trolley for chairs with accessories

code	finishing	q.kit	kg.x1
110803-346	● nero/black	x1	10,50

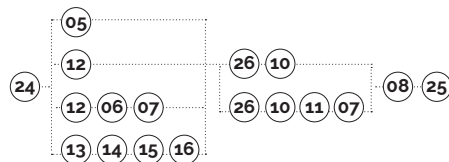

main component sizes

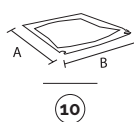
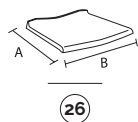
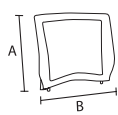
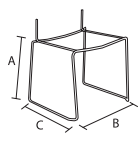

### 24 x3-telaio 4 gambe d.18 x3-4 legs frame d.18

code	finishing	q.kit	q.pack	a	b	c	kg.x1	vol.x1
112703-050	● nero/black	x1	60	455	465	550	2,20	mc. 0.03
112704-050	● grigio/gray	x1	60	455	465	550	2,20	mc. 0.03
112710-050	● cromato/chrome	x1	60	455	465	550	2,20	mc. 0.03

### 25 confezione puntali tondi d.18 neri black inner round caps d.18 package

code	finishing	q.kit	q.pack
137003-072	● nero/black	x4	200

### 05 x3-schienale colorato a vista in plastica pieno x3-colored full plastic back

code	finishing	q.kit	q.pack	a	b	kg.x1	vol.x1
132104-090	● grigio/gray ral7003	x1	10	400	460	0,90	mc. 0.008

### 08 x3-riduttore per schienale in plastica x3-plastic adapter for the back

code	finishing	q.kit	q.pack	kg.x1	vol.x1
132103-009	● nero/black	x2	200	0,019	mc. 0.0001

### 26 x3-sedile colorato a vista in plastica per telaio 4 gambe x3-colored plastic seat for 4-legs frame

code	finishing	q.kit	q.pack	a	b	kg.x1	vol.x1
132204-018	● grigio/gray ral7003	x1	10	450	460	1,20	mc. 0.015

### 10 x3-sottosedile colorato a vista in plastica x3-outer colored plastic seat

code	finishing	q.kit	q.pack	a	b	kg.x1	vol.x1
132204-009	● grigio/gray ral7003	x1	20	450	460	0,73	mc. 0.007



for all colour codes, see page 93

# X3

## 4-legs/backrest and seat options

main component sizes

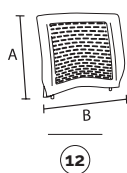

**12** x3-schienale colorato a vista in plastica forato  
x3-colored plastic back with holes

code	finishing	q.kit	q.pack	a	b	kg.x1	vol.x1
132102-019	● rosso/red 527	x1	10	400	460	0,90	mc. 0.008

and · (26) (10)

main component sizes

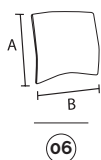

**06** x3-pannello schienale da tappezzare in plastica  
x3-back panel for upholstery

code	finishing	q.kit	q.pack	a	b	kg.x1	vol.x1
132103-008	● nero/black	x1	20	350	385	0,50	mc. 0.003

**11** x3-pannello sedile da tappezzare in plastica  
x3-seat panel for upholstery

code	finishing	q.kit	q.pack	a	b	kg.x1	vol.x1
132203-003	● nero/black	x1	20	400	410	0,60	mc. 0.003

**07** vite hilo tb+ 5x12 cementata brunita nera  
screw tb+fr.hilo 5x12 black burnished

code	finishing	q.kit seat	q.kit back
117803-154	● nero/black	x8	x6

and · (12) (26) (10)

main component sizes

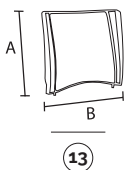

**13** x3-schienale per rete nero a vista in plastica  
x3-black plastic for mesh back

code	finishing	q.kit	q.pack	a	b	kg.x1	vol.x1
132103-014	● nero/black	x1	10	400	460	0,60	mc. 0.008

**14** x3-liste a\*b per schienale rete nere a vista  
x3-black plastic strips a\*b for mesh back

code	finishing	q.kit	q.pack	kg.x1	vol.x1
132103-013	● nero/black	x1	100	0,21	mc. 0.0004

**15** x3-rete per schienale  
x3-net for back

code	finishing	q.kit	q.pack	a	b	kg.x1	vol.x1
132103-029	● nero/black	x1	50	400	460	0,14	mc. 0.0057

**16** vite truciolare tsp+ d.3,5x10 brunita nera(per fissare schienale rete)  
shaving screw tsp+ d.3,5x10 zinc.(to fix mesh back)

code	finishing	q.kit
117803-105	● nero/black	x8

and · (26) (10) (11) (07)

# X3

4-legs w/writing tablet

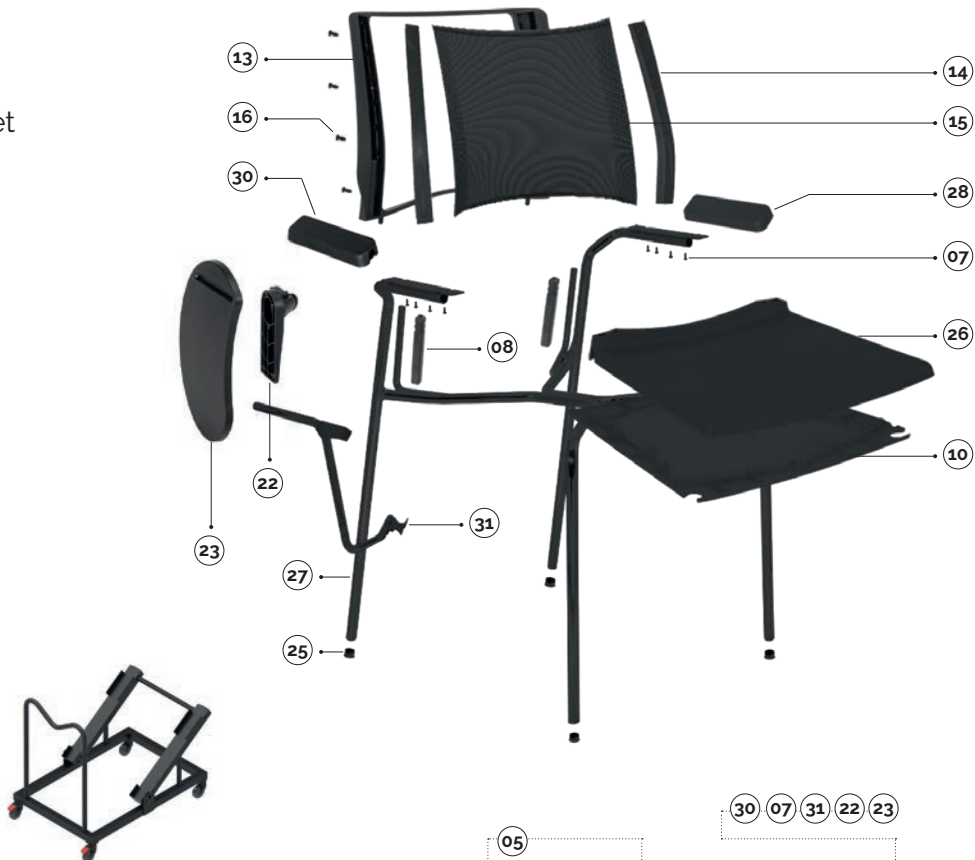

plastic colours

- grigio/gray ral 7003
- nero/black
- rosso/red 527
- bianco/white ral 1013

x3-carrello portasedie con accessori  
x3-trolley for chairs with accessories

code	finishing	q.kit	kg.x1
110803-346	● nero/black	x1	10,50

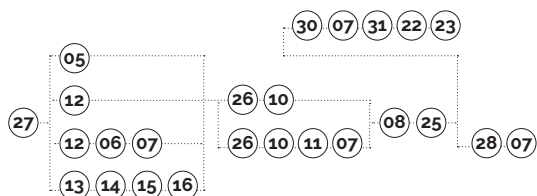

main component sizes

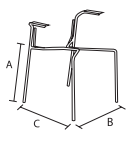

27

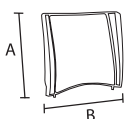

13

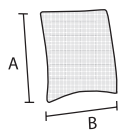

15

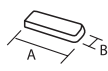

28

**27** x3-telaio 4 gambe d.18 con braccioli  
x3-4 legs frame d.18 with arms

code	finishing	q.kit	q.pack	a	b	c	kg.x1	vol.x1
112703-051	● nero/black	x1	60	455	465	550	2,80	mc. 0.035
112704-051	● grigio/gray	x1	60	455	465	550	2,80	mc. 0.035
112710-054	● cromato/chrome	x1	60	455	465	550	2,80	mc. 0.035

**13** x3-schienale per rete nero a vista in plastica  
x3-black plastic for mesh back

code	finishing	q.kit	q.pack	a	b	kg.x1	vol.x1
132103-014	● nero/black	x1	10	400	460	0,60	mc. 0.008

**14** x3-liste a+b per schienale rete nere a vista  
x3-black plastic strips a+b for mesh back

code	finishing	q.kit	q.pack	kg.x1	vol.x1
132103-013	● nero/black	x1	100	0,21	mc. 0.0004

**15** x3-rete per schienale  
x3-net for back

code	finishing	q.kit	q.pack	a	b	kg.x1	vol.x1
132103-029	● nero/black	x1	50	400	460	0,14	mc. 0.0057

**16** vite truccolare tsp+ d.3,5x10 brunita nera(per fissare schienale rete)  
shaving screw tsp+ d.3,5x10 zinc.(to fix mesh back)

code	finishing	q.kit
117803-105	● nero/black	x8

**28** x3-bracciolo plastica colorato per telaio 4 gambe  
x3-colored plastic arm for 4 legs frame

code	finishing	q.kit	q.pack	a	b	kg.x1	vol.x1
131703-017	● nero/black	x2	40	175	55	0,10	mc. 0.0004

**07** vite hilo tb+ 5x12 cementata brunita nera  
screw tb+fr.hilo 5x12 black burnished

code	finishing	q.kit seat	q.kit back
117803-154	● nero/black	x8	x6

for the components below, see page 82



for all colour codes, see page 93

25 08 26 10

# X3

## 4-legs/tablet accessories

main component sizes

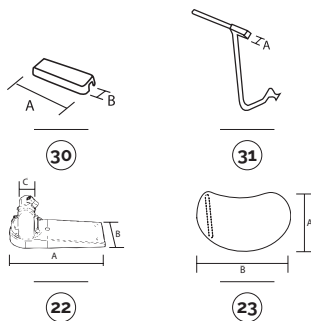

### 30 x3-bracciolo plastica colorato per telaio 4 gambe con tavoletta

code	finishing	q.kit	q.pack	a	b	kg.x1	vol.x1
131703-014	● nero/black	x2	40	175	55	0,10	mc. 0,0004

### 31 x3-supperto tavoletta per 4 gambe + viti

code	finishing	q.kit	q.pack	kg.x1	vol.x1
111703-043	● nero/black destro/right - 4 gambe/legs	x1	10	15x15	0,60 mc. 0,002
111703-046	● nero/black sinistro/left - 4 gambe/legs	x1	10	15x15	0,60 mc. 0,002
111710-037	● cromato/chrome destro/right - 4 gambe/legs	x1	10	15x15	0,60 mc. 0,002
111710-039	● cromato/chrome sinistro/left - 4 gambe/legs	x1	10	15x15	0,60 mc. 0,002

### 22 spt2-snodo per tavoletta in plastica

code	finishing	q.kit	q.pack	a	b	c	kg.x1	vol.x1
134003-039	● nero/black	x1	20	180	66	15x15	0,35	mc. 0,0006

### 23 bean-tavoletta in plastica spessore 16

code	finishing	q.kit	q.pack	a	b	kg.x1	vol.x1
134003-044	● nero/black	x1	20	235	370	0,40	mc. 0,002



for writing tablet options, see page 192/193

## 4-legs w/armrests/backrest and seat options

main component sizes

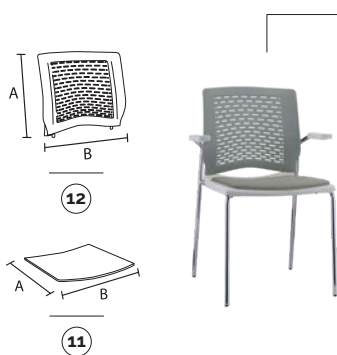

CERTIFIED BY  
**BIFMA**

### 12 x3-schienale colorato a vista in plastica forato

code	finishing	q.kit	q.pack	a	b	kg.x1	vol.x1
132104-019	● grigio/gray ral 7003	x1	10	400	460	0,90	mc. 0,008

### 11 x3-pannello sedile da tappezzare in plastica

code	finishing	q.kit	q.pack	a	b	kg.x1	vol.x1
132203-003	● nero/black	x1	20	400	410	0,60	mc. 0,003

### 07 vite hilo tb+ 5x12 cementata brunita nera

code	finishing	q.kit seat	q.kit back
117803-154	● nero/black	x8	x6

and **26 10**

main component sizes

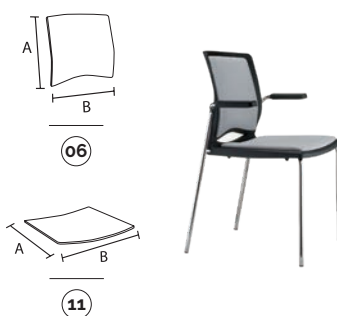

### 06 x3-pannello schienale da tappezzare in plastica

code	finishing	q.kit	q.pack	a	b	kg.x1	vol.x1
132103-008	● nero/black	x1	20	350	385	0,50	mc. 0,003

### 11 x3-pannello sedile da tappezzare in plastica

code	finishing	q.kit	q.pack	a	b	kg.x1	vol.x1
132203-003	● nero/black	x1	20	400	410	0,60	mc. 0,003

### 07 vite hilo tb+ 5x12 cementata brunita nera

code	finishing	q.kit seat	q.kit back
117803-154	● nero/black	x8	x6

and **12 26 10**

# X3 swivel



plastic colours

- grigio/gray ral 7003
- nero/black
- rosso/red 527
- bianco/white ral 1013

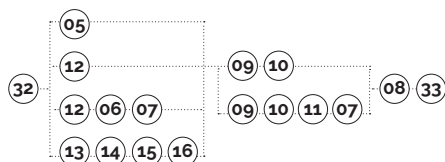

main component sizes

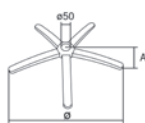

32

33

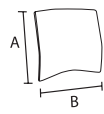
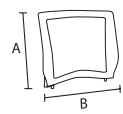

05

06

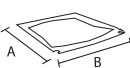
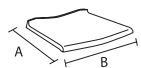

09

10

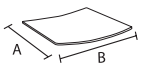

11

### 32 x3-telaio girevole a gas x3-swivel wire frame d.12

code	finishing	q.kit	q.pack	kg.x1	vol.x1
110903-028	● nero/black	x1	100	3,00	mc. 0,02
110904-014	● grigio/gray	x1	100	3,00	mc. 0,02

### 33 b40 base in metallo d.640 con coprisaldatura b40 metal base d.640 with cover welding

code	finishing	q.kit	q.pack	a	o	kg.x1	vol.x1
110210-027	● cromato/chrome	x1	5	60	640	2,85	mc. 0,014

### 05 x3-schienale colorato a vista in plastica pieno x3-colored full plastic back

code	finishing	q.kit	q.pack	a	b	kg.x1	vol.x1
132105-090	○ bianco/white ral 1013	x1	10	400	460	0,90	mc. 0,008

### 06 x3-pannello schienale da tappezzare in plastica x3-back panel for upholstery

code	finishing	q.kit	q.pack	a	b	kg.x1	vol.x1
132103-008	● nero/black	x1	20	350	385	0,50	mc. 0,003

### 07 vite hilo tb\* 5x12 cementata brunita nera screw tb+fr.hilo 5x12 black burnished

code	finishing	q.kit seat	q.kit back
117803-154	● nero/black	x8	x6

### 08 x3-riduttore per schienale in plastica x3-plastic adapter for the back

code	finishing	q.kit	q.pack	kg.x1	vol.x1
132103-009	● nero/black	x2	200	0,019	mc. 0,0001

### 09 x3-sedile colorato a vista in plastica per telaio slitta x3-colored plastic seat for wire frame

code	finishing	q.kit	q.pack	a	b	kg.x1	vol.x1
132205-019	○ bianco/white ral 1013	x1	10	450	460	1,20	mc. 0,015

### 10 x3-sottosedile colorato a vista in plastica x3-outer colored plastic seat

code	finishing	q.kit	q.pack	a	b	kg.x1	vol.x1
132205-009	○ bianco/white ral 1013	x1	20	450	460	0,73	mc. 0,007

### 11 x3-pannello sedile da tappezzare in plastica x3-seat panel for upholstery

code	finishing	q.kit	q.pack	a	b	kg.x1	vol.x1
132203-003	● nero/black	x1	20	400	410	0,60	mc. 0,003



# X3

## swivel/backrest and seat options

main component sizes

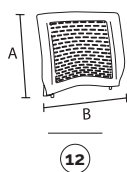

**12** X3-schienale colorato a vista in plastica forato  
X3-colored plastic back with holes

code	finishing	q.kit	q.pack	a	b	kg.x1	vol.x1
132105-019	○ bianco/white ral 1013	x1	10	400	460	0,90	mc. 0,008

and · **09** **10**

main component sizes

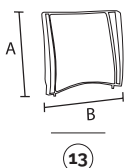

**13** X3-schienale per rete nero a vista in plastica  
X3-black plastic for mesh back

code	finishing	q.kit	q.pack	a	b	kg.x1	vol.x1
132103-014	● nero/black	x1	10	400	460	0,60	mc. 0,008

**14** X3-liste a\*b per schienale rete nere a vista  
X3-black plastic strips a\*b for mesh back

code	finishing	q.kit	q.pack	kg.x1	vol.x1
132103-013	● nero/black	x1	100	0,21	mc. 0,0004

**15** X3-rete per schienale  
X3-net for back

code	finishing	q.kit	q.pack	a	b	kg.x1	vol.x1
132103-029	● nero/black	x1	50	400	460	0,14	mc. 0,0057

**16** vite truciolare tsp\* d.3,5x10 brunita nera(per fissare schienale rete)  
shaving screw tsp\* d.3,5x10 zinc.(to fix mesh back)

code	finishing	q.kit
117803-105	● nero/black	x8

and · **09** **10** **11** **07**



# X3

swivel w/armrests



plastic colours

- grigio/gray ral 7003
- nero/black
- rosso/red 527
- bianco/white ral 1013

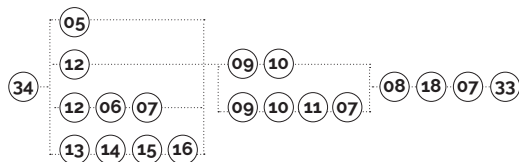

main component sizes

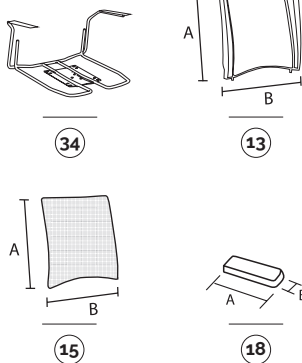

**34** x3-telaio girevole a gas con braccioli  
x3-swivel wire frame with arms d.12

code	finishing	q.kit	q.pack	kg.x1	vol.x1
110903-027	● nero/black	x1	100	4,00	mc. 0,02
110904-015	● grigio/gray	x1	100	4,00	mc. 0,02
110910-015	● cromato/chrome	x1	100	4,00	mc. 0,02

**13** x3-schienale per rete nero a vista in plastica  
x3-black plastic for mesh back

code	finishing	q.kit	q.pack	a	b	kg.x1	vol.x1
132103-014	● nero/black	x1	10	400	460	0,60	mc. 0,008

**14** x3-liste a+b per schienale rete nere a vista  
x3-black plastic strips a+b for mesh back

code	finishing	q.kit	q.pack	kg.x1	vol.x1
132103-013	● nero/black	x1	100	0,21	mc. 0,0004

**15** x3-rete per schienale  
x3-net for back

code	finishing	q.kit	q.pack	a	b	kg.x1	vol.x1
132103-029	● nero/black	x1	50	400	460	0,14	mc. 0,0057

**16** vite trucciolare tsp+ d.3,5x10 brunita nera(per fissare schienale rete)  
shaving screw tsp+ d.3,5x10 zinc.(to fix mesh back)

code	finishing	q.kit
117803-105	● nero/black	x8

**18** x3-bracciolo plastica colorata per telaio filo  
x3-colored plastic arm for wire frame

code	finishing	q.kit	q.pack	a	b	kg.x1	vol.x1
131703-019	● nero/black	x2	40	175	55	0,10	mc. 0,0004

**07** vite hilo tb+ 5x12 cementata brunita nera  
screw tb+fr.hilo 5x12 black burnished

code	finishing	q.kit seat	q.kit back
117803-154	● nero/black	x8	x6

for the components below, see page 86

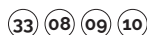

for all colour codes, see page 93

# X3

## swivel w/armrests/backrest and seat options

main component sizes

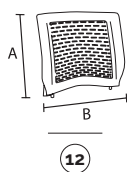

**12** x3-schienale colorato a vista in plastica forato  
x3-colored plastic back with holes

code	finishing	q.kit	q.pack	a	b	kg.x1	vol.x1
132104-019	● grigio/gray ral 7003	x1	10	400	460	0,90	mc. 0,008

and · **09** **10**

main component sizes

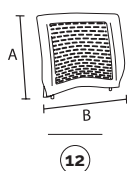

**12** x3-schienale colorato a vista in plastica forato  
x3-colored plastic back with holes

code	finishing	q.kit	q.pack	a	b	kg.x1	vol.x1
132105-019	○ bianco/white ral 1013	x1	10	400	460	0,90	mc. 0,008

**06** x3-pannello schienale da tappezzare in plastica  
x3-back panel for upholstery

code	finishing	q.kit	q.pack	a	b	kg.x1	vol.x1
132103-008	● nero/black	x1	20	350	385	0,50	mc. 0,003

**11** x3-pannello sedile da tappezzare in plastica  
x3-seat panel for upholstery

code	finishing	q.kit	q.pack	a	b	kg.x1	vol.x1
132203-003	● nero/black	x1	20	400	410	0,60	mc. 0,003

**07** vite hilo tb+ 5x12 cementata brunita nera  
screw tb+fr.hilo 5x12 black burnished

code	finishing	q.kit seat	q.kit back
117803-154	● nero/black	x8	x6

and · **09** **10**

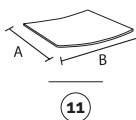
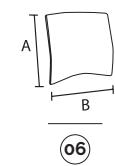

# X3 bench

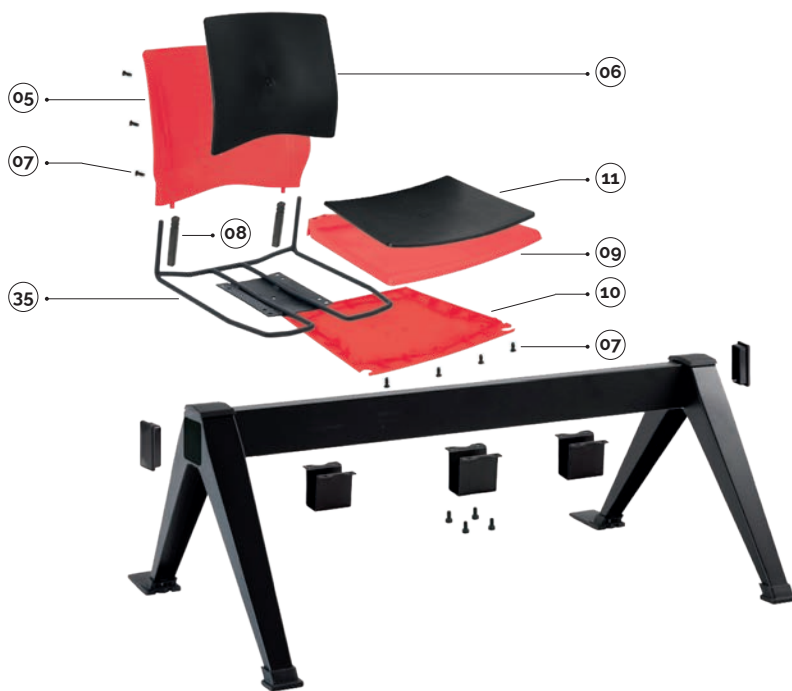

plastic colours

- grigio/gray ral 7003
- nero/black
- rosso/red 527
- bianco/white ral 1013

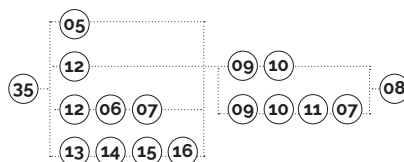

main component sizes

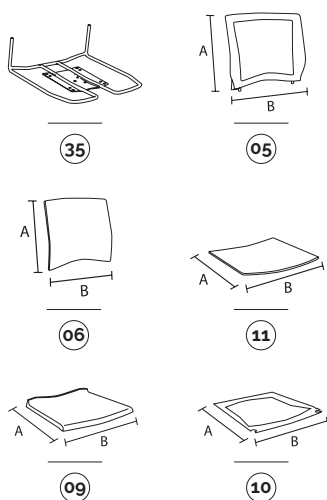

### 35 x3-telaio per panca x3-bench wire frame d.12

code	finishing	q.kit	q.pack	kg.x1	vol.x1
110703-041	● nero/black	x1	100	2,70	mc. 0,02
110704-039	● grigio/gray	x1	100	2,70	mc. 0,02

### 05 x3-schienale colorato a vista in plastica pieno x3-colored full plastic back

code	finishing	527	q.kit	q.pack	a	b	kg.x1	vol.x1
132102-090	● rosso/red	527	x1	10	400	460	0,90	mc. 0,008

### 06 x3-pannello schienale da tappezzare in plastica x3-plastic panel for upholstery

code	finishing	q.kit	q.pack	a	b	kg.x1	vol.x1
132103-008	● nero/black	x1	20	350	385	0,50	mc. 0,003

### 07 vite hilo tb+ 5x12 cementata brunita nera screw tb+fr.hilo 5x12 black burnished

code	finishing	q.kit seat	q.kit back
117803-154	● nero/black	x8	x6

### 08 x3-riduttore per schienale in plastica x3-plastic adapter for the back

code	finishing	q.kit	q.pack	kg.x1	vol.x1
132103-009	● nero/black	x2	200	0,019	mc. 0,0001

### 09 x3-sedile colorato a vista in plastica per telaio slitta x3-colored plastic seat for wire frame

code	finishing	527	q.kit	q.pack	a	b	kg.x1	vol.x1
132202-019	● rosso/red	527	x1	10	450	460	1,20	mc. 0,015

### 10 x3-sottosedile colorato a vista in plastica x3-outer colored plastic seat

code	finishing	527	q.kit	q.pack	a	b	kg.x1	vol.x1
132202-009	● rosso/red	527	x1	20	450	460	0,73	mc. 0,007

### 11 x3-pannello sedile da tappezzare in plastica x3-seat panel for upholstery

code	finishing	q.kit	q.pack	a	b	kg.x1	vol.x1
132203-003	● nero/black	x1	20	400	410	0,60	mc. 0,003

for the bench components, see page 201



for all colour codes, see page 93

# X3

bench w/armrests

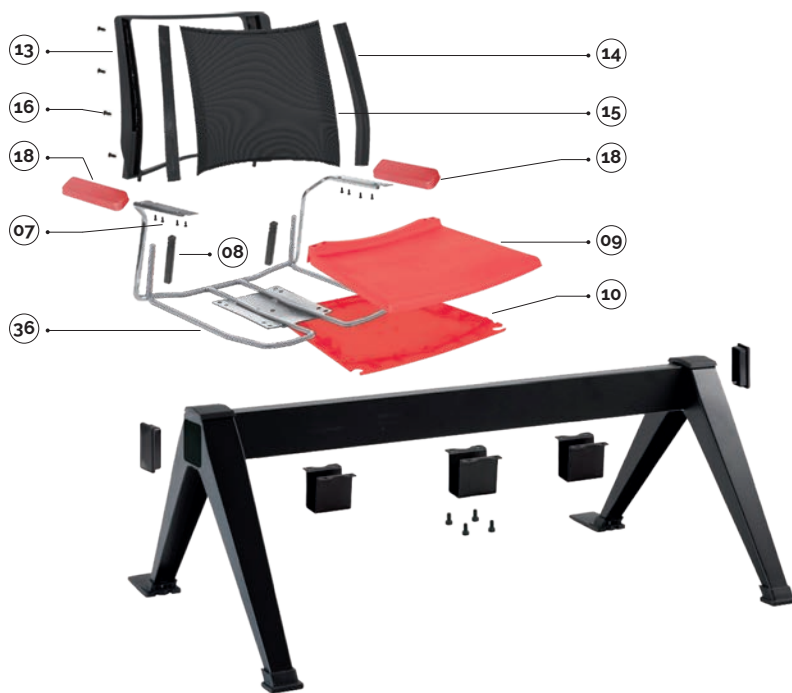

plastic colours

- grigio/gray ral 7003
- nero/black
- rosso/red 527
- bianco/white ral 1013

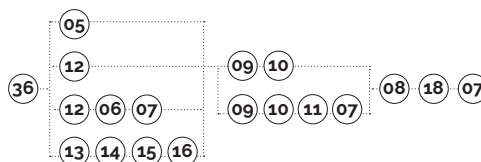

main component sizes

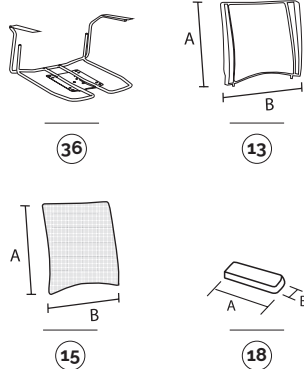

for the components below, see page 90

08 09 10

for all colour codes, see page 93

**36** x3-telaio per panca con braccioli  
x3-bench wire frame d.12 with arms

code	finishing	q.kit	q.pack	kg.x1	vol.x1
110703-044	● nero/black	x1	100	3,60	mc. 0,02
110704-210	● grigio/gray	x1	100	3,60	mc. 0,02
110710-044	● cromato/chrome	x1	100	3,60	mc. 0,02

**13** x3-schienale per rete nero a vista in plastica  
x3-black plastic for mesh back

code	finishing	q.kit	q.pack	a	b	kg.x1	vol.x1
132103-014	● nero/black	x1	10	400	460	0,60	mc. 0,008

**14** x3-liste a+b per schienale rete nere a vista  
x3-black plastic strips a+b for mesh back

code	finishing	q.kit	q.pack	kg.x1	vol.x1
132103-013	● nero/black	x1	100	0,21	mc. 0,0004

**15** x3-rete per schienale  
x3-net for back

code	finishing	q.kit	q.pack	a	b	kg.x1	vol.x1
132103-029	● nero/black	x1	50	400	460	0,14	mc. 0,0057

**16** vite truccolare tsp+ d.3,5x10 brunita nera(per fissare schienale rete)  
shaving screw tsp+ d.3,5x10 zinc.(to fix mesh back)

code	finishing	q.kit
117803-105	● nero/black	x8

**18** x3-bracciolo plastica colorato per telaio filo  
x3-colored plastic arm for wire frame

code	finishing	q.kit	q.pack	a	b	kg.x1	vol.x1
131702-019	● rosso/red 527	x2	40	175	55	0,10	mc. 0,0004

**07** vite hilo tb+ 5x12 cementata brunita nera  
screw tb+fr.hilo 5x12 black burnished

code	finishing	q.kit seat	q.kit back
117803-154	● nero/black	x8	x6

optionals

OPTIONAL bench connector

E-USB NEW bench plug

JIM NEW bench leg

APOLL bench arm

90GM bench leg

90GF bench leg

100GM bench leg

200GM bench leg

PIONEER bench arm

CUT bench leg

SLIM bench leg

CUT bench arm

SLIM bench arm



plastic

metal

aluminium

# X3

## bench w/armrests/backrest and seat options

main component sizes

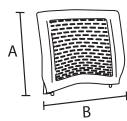

12



11



12 x3-schienale colorato a vista in plastica forato  
x3-colored plastic back with holes

code	finishing	q.kit	q.pack	a	b	kg.x1	vol.x1
132104-019	● grigio/gray ral 7003	x1	10	400	460	0,90	mc. 0,008

11 x3-pannello sedile da tappezzare in plastica  
x3-seat panel for upholstery

code	finishing	q.kit	q.pack	a	b	kg.x1	vol.x1
132203-003	● nero/black	x1	20	400	410	0,60	mc. 0,003

07 vite hilo tb+ 5x12 cementata brunita nera  
screw tb+fr.hilo 5x12 black burnished

code	finishing	q.kit seat	q.kit back
117803-154	● nero/black	x8	x6

and - 09 10

main component sizes

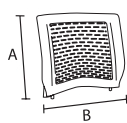

12

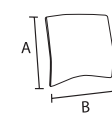

06

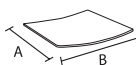

11



12 x3-schienale colorato a vista in plastica forato  
x3-colored plastic back with holes

code	finishing	q.kit	q.pack	a	b	kg.x1	vol.x1
132105-019	○ bianco/white ral 1013	x1	10	400	460	0,90	mc. 0,008

06 x3-pannello schienale da tappezzare in plastica  
x3-back panel for upholstery

code	finishing	q.kit	q.pack	a	b	kg.x1	vol.x1
132103-008	● nero/black	x1	20	350	385	0,50	mc. 0,003

11 x3-pannello sedile da tappezzare in plastica  
x3-seat panel for upholstery

code	finishing	q.kit	q.pack	a	b	kg.x1	vol.x1
132203-003	● nero/black	x1	20	400	410	0,60	mc. 0,003

07 vite hilo tb+ 5x12 cementata brunita nera  
screw tb+fr.hilo 5x12 black burnished

code	finishing	q.kit seat	q.kit back
117803-154	● nero/black	x8	x6

and - 09 10

# X3

## optional colour codes



### plastic colour codes



**12** schienale in plastica con fori  
plastic backrest with holes

- 132104-019 grigio/gray ral 7003
- 132103-019 nero/black
- 132102-019 rosso/red 527
- 132105-019 bianco/white ral 1013



**05** schienale in plastica pieno  
full plastic backrest

- 132104-090 grigio/gray ral 7003
- 132103-090 nero/black
- 132102-090 rosso/red 527
- 132105-090 bianco/white ral 1013



**09** sedile in plastica per telaio slitta  
plastic seat for wire frame

- 132204-019 grigio/gray ral 7003
- 132203-019 nero/black
- 132202-019 rosso/red 527
- 132205-019 bianco/white ral 1013



**26** sedile in plastica per telaio 4 gambe  
plastic seat for 4-legs frame

- 132204-018 grigio/gray ral 7003
- 132203-018 nero/black
- 132202-018 rosso/red 527
- 132205-018 bianco/white ral 1013

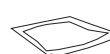

**10** sottosedile in plastica  
outer plastic seat

- 132204-009 grigio/gray ral 7003
- 132203-009 nero/black
- 132202-009 rosso/red 527
- 132205-009 bianco/white ral 1013



**18** bracciolo in plastica per telaio slitta  
plastic arm for wire frame

- 131704-019 grigio/gray ral 7003
- 131703-019 nero/black
- 131702-019 rosso/red 527
- 131705-019 bianco/white ral 1013



**20** bracciolo in plastica per telaio slitta con tavoletta  
plastic arm for wire frame with tablet

- 131704-018 grigio/gray ral 7003
- 131703-018 nero/black
- 131702-018 rosso/red 527
- 131705-018 bianco/white ral 1013



**28** bracciolo in plastica per telaio 4 gambe  
plastic arm for 4-legs frame

- 131704-017 grigio/gray ral 7003
- 131703-017 nero/black
- 131702-017 rosso/red 527
- 131705-017 bianco/white ral 1013



**30** bracciolo in plastica per telaio 4 gambe con tavoletta  
plastic arm for 4-legs frame with tablet

- 131704-014 grigio/gray ral 7003
- 131703-014 nero/black
- 131702-014 rosso/red 527
- 131705-014 bianco/white ral 1013

